

B45196H, Tantalum, MnO2 Tantalum, 6.8 uF, 20%, 50 V, SMD, Molded, 7343, Height Max = 4.4mm

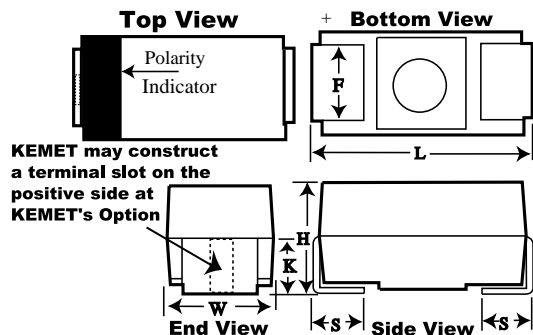

General Information	
Supplier:	KEMET
Series:	B45196H
Dielectric:	MnO2 Tantalum
Style:	SMD Chip
Description:	SMD, Molded
RoHS:	Yes
Termination:	Tin
Notes:	Obsolete. Old Part Number [Obsolete] Was B45196H7685M509

Dimensions	
Footprint	7343
L	7.3mm +/-0.3mm
W	4.3mm +/-0.3mm
H	4.1mm +/-0.3mm
S	1.3mm +/-0.3mm
F	2.4mm +/-0.1mm
K	1.8mm TYP

Specifications	
Capacitance:	6.8 uF
Capacitance Tolerance:	20%
Voltage DC:	50 VDC (85C), 33.5 VDC (125C)
Temperature Range:	-55/+125C
Rated Temperature:	85C
Dissipation Factor:	6%
Failure Rate:	N/A
Leakage Current:	3.4 uA

Packaging Specifications	
Packaging:	T&R, 178mm
Packaging Quantity:	400