

# LTC3789EGN: High Efficiency Synchronous 4-Switch Step-Up/Step-Down DC/DC Converter

## DESCRIPTION

Demonstration circuit 1523A features the LTC<sup>®</sup>3789EGN, a high efficiency switching step-up/down controller. The DC1523A input range is from 5V to 36V. The output voltage is 12V. The board is capable of delivering up to 5A of output current over the input voltage range.

The LTC3789EGN is a high performance switching regulator controller designed to regulate the output using input voltages above, below or equal to the output voltage. Synchronous operation provides very high efficiency, up to 97%. Constant frequency current mode architecture allows phase-lockable frequency from 200kHz to 600kHz. An accurate output current limit provides support for battery charging. A wide input and output range with

smooth transfer function through all operating modes makes the product ideal for automotive, telecom and battery systems.

The MODE/PLLIN pin can select between pulse skipping mode and forced continuous mode operation and allows the IC to be synchronized to an external clock. A Power Good output pin indicates when the output is within 7.5% of its set point.

**Design files for this circuit board are available at <http://www.linear.com/demo>**

LT, LT, LTC, LTM, Linear Technology and the Linear logo are registered trademarks of Linear Technology Corporation. All other trademarks are the property of their respective owners.

## PERFORMANCE SUMMARY

PARAMETER	CONDITIONS/NOTES	VALUE
Minimum Input Voltage		5V
Maximum Input Voltage		36V
Output Voltage $V_{OUT}$ Regulation	$V_{IN} = 5V$ to 36V, $I_{OUT} = 0A$ to 5A	12V $\pm 2\%$
Maximum Continuous Output Current	Some Airflow May be Needed at Low Input Voltage and Continuous Full Load	5A DC
Default Operating Frequency	R3 = 121k	400kHz
External Clock Synchronous Frequency Range		200kHz to 600kHz
Efficiency	$V_{IN} = 5V$ to 36V, $I_{OUT} = 5A$	88% to 97%. See Figures 3 and 6
Load Transient		See Figure 5

## QUICK START PROCEDURE

Demonstration circuit 1523A is easy to set up to evaluate the performance of the LTC3789EGN. Please refer to Figure 1 for proper measurement equipment setup and follow the procedure below.

1. With power off, connect the input supply, load and meters as shown in Figure 1. Preset the load to 0A and VIN supply to 0V.
2. Set the current limit of the input supply high enough so that the bench supply does not go into current limit mode. Figure 2 shows input current as a function of input voltage, at full load. Input current can reach 13A at 5V input voltage.
3. Place jumpers in the following positions:

JP1	JP2
RUN	MODE
ON	CCM

4. Turn on the power at the input. Increase  $V_{IN}$  to between 5V and 36V. The circuit will start and the output voltage will regulate at  $12V \pm 2\%$ . The current draw at no load is 20mA to 60mA depending on the input voltage.

5. Apply load and observe output voltage regulation, ripple voltage, efficiency and other parameters. Efficiency and power loss at full load is shown in Figure 3. Continuous operation with full power and low input voltage may require some airflow.

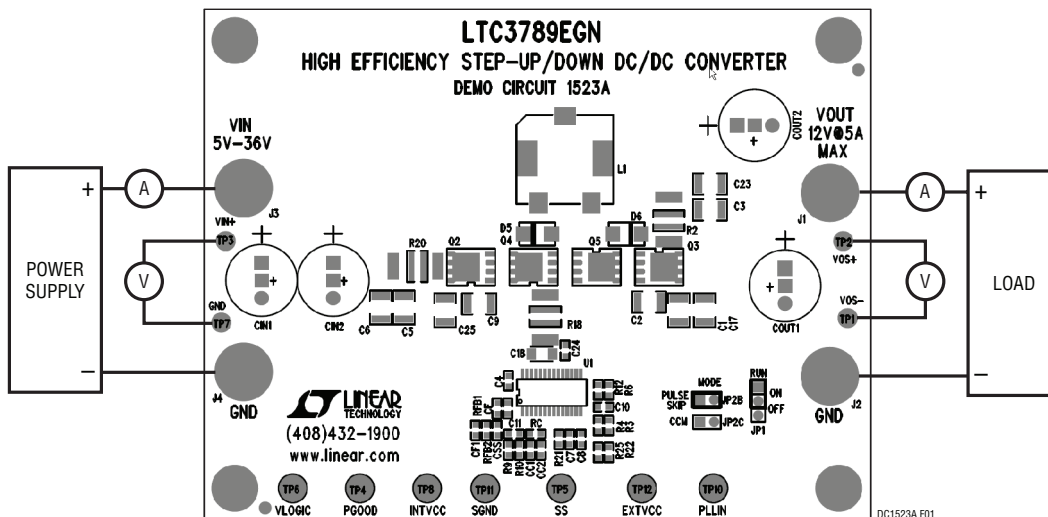
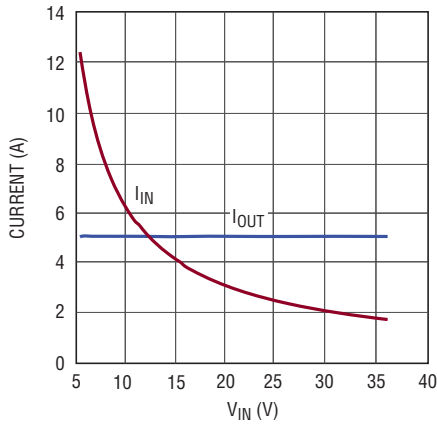

Figure 1. Proper Measurement Equipment Setup

**QUICK START PROCEDURE**



DC1523A F02

Figure 2. Input Current at Full Load (12V at 5A Out)

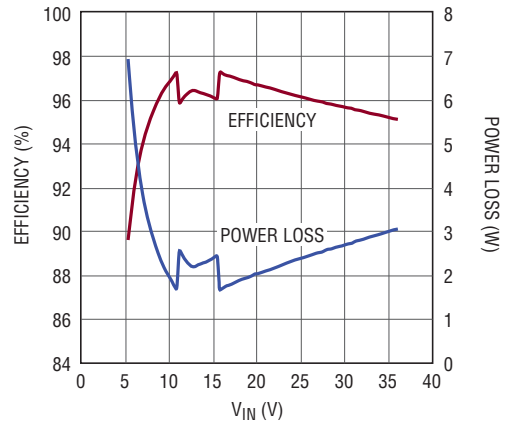

DC1523A F03

Figure 3. Efficiency and Power Loss at Full Load. The Power Loss is Highest in Boost Mode Due to the High Inductor Current, and Drops as Input Voltage Increases. Switching Losses Again Increase when  $V_{IN} > V_{OUT}$ . All Four MOSFETs are Switching in Buck-Boost Mode and This Shows Up as a Small Increase in Losses When  $V_{IN} = 11V$  to  $15.5V$

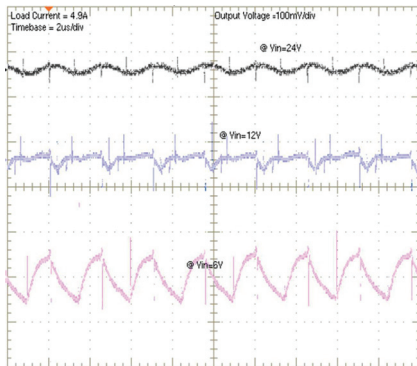

Figure 4. Output Ripple Voltage at  $24V_{IN}$  (Top),  $12V_{IN}$  (Middle),  $6V_{IN}$  (Bottom). Measured Across  $C_{OUT1}$ , BW = 20MHz, 100mV/Div

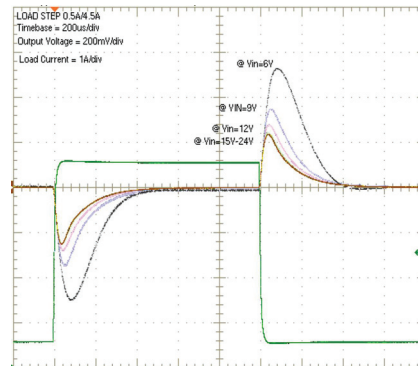
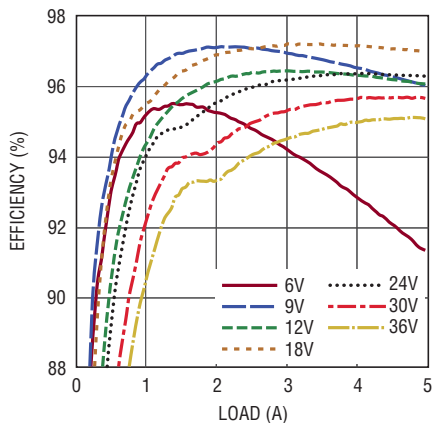
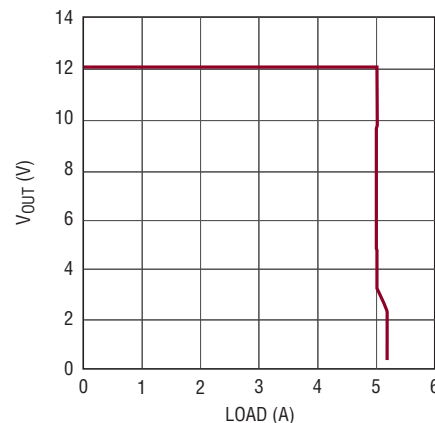

Figure 5. Load Transient Response



DC1523 F06

Figure 6. Efficiency at Various Input Voltages



DC1523A F07

Figure 7. Output Current Limit. ( $V_{IN} = 12V$ . The Easiest Way to Do This Test is with an Active Load in Voltage Mode)

# DEMO MANUAL DC1523A

## PARTS LIST

ITEM	QTY	REFERENCE	PART DESCRIPTION	MANUFACTURER/PART NUMBER
<b>Required Circuit Components</b>				
1	1	CC1	CAP, COG, 1000pF, 50V, 10% 0603	AVX, 06035A102KAT2A
2	2	CC2, CSS	CAP, X7R, 0.01µF, 50V, 10% 0603	AVX, 06035C103KAT2A
3	1	CIN1	CAP, Alum, 270µF, 50V, 20%	SANYO, 50ME270WX+T
4	1	COUT1	CAP, OS-CON, 330µF, 16V, 20%	SANYO, 16SEP330M+T
5	4	C1, C2, C16, C17	CAP, X7R, 22µF, 16V, 20% 1210	AVX, 1210YC226MAT2A
6	2	C4, C22	CAP, X7R, 0.22µF, 16V, 20% 0603	TAIYO YUDEN, EMK107BJ224MA
7	4	C5, C6, C9, C25	CAP, X7R, 3.3µF, 50V, 20% 1210	AVX, 12105C335MAT2A
8	1	C10	CAP, X7R, 2.2µF, 10V, 10% 0603	MURATA, GRM188R71A225K
9	1	C12	CAP, NPO, 390pF, 100V, 10% 1206	AVX, 12061A391KAT2A
10	1	C13	CAP, NPO, 1800pF, 100V, 10% 1206	AVX, 12061A182KAT2A
11	1	C14	CAP, X7R, 0.1µF, 50V, 10% 0603	AVX, 06035C104KAT2A
12	1	C15	CAP, X7R, 1µF, 50V, 20% 1206-1210	AVX, 12065C105MAT2A
13	1	C18	CAP, X7R, 10µF, 10V, 20% 1206	AVX, 1206ZC106MAT2A
14	1	C24	CAP, X7R, 1µF, 16V, 20% 0603	AVX, 0603YC105MAT2A
15	1	D2	DIODE, BAS16, SOT23	DIODES, BAS16
16	2	D7, D4	SCHOTTKY REC., DFLS160, PowerDI-123	DIODES INC., DFLS160
17	2	D5, D6	SCHOTTKY RECT., B240A SMA	DIODES INC. B240A-13-F
18	1	D8	ZENER DIODE, 5.1V, BZX84C5V1, SOT23	DIODES INC. BZX84C5V1-7-F
19	1	L1	INDUCTOR, 4.7µH	TOKO, FDA1254-4R7M
20	1	Q2	MOSFET N-CHAN., 40V	VISHAY, Si7884BDP-T1-E3
21	1	Q4	MOSFET N-CHAN., 40V	VISHAY, Si4840BDY-T1-E3
22	2	Q3, Q5	MOSFET N-CHAN., SiR496DP, 20V	VISHAY, SiR496DP-T1-GE3
23	1	RC	RES., CHIP, 14.7k, 0.1W, 1% 0603	VISHAY, CRCW060314K7FKEA
24	1	RFB1	RES., CHIP, 113k, 0.1W, 1% 0603	VISHAY, CRCW0603113KFKEA
25	1	RFB2	RES., CHIP, 8.06k, 0.1W, 1% 0603	VISHAY, CRCW06038K06FKEA
26	1	R1	RES., CHIP, 5.6Ω, 0.1W, 1% 0603	VISHAY, CRCW06035R60FKEA
27	2	R2, R18	Sensor Res., 0.01Ω, 1W, 2%, RL3720W	Thin Film Tech., RL3720WT-R010-G-C
28	4	R3, R4, R13, R14	RES., CHIP, 100Ω, 0.1W, 5%, 0603	VISHAY, CRCW0603100RJNEA
29	1	R5	RES., CHIP, 15Ω, 0.125W, 1% 0603	VISHAY, CRCW060315R0FKEA
30	1	R7	RES., CHIP, 100k, 0.1W, 1% 0603	VISHAY, CRCW0603100KFKEA
31	3	R8, R11, R26	RES., CHIP, 10Ω, 0.1W, 5% 0603	VISHAY, CRCW060310R0JNEA
32	2	R10, R9	RES., CHIP, 1.24k, 0.1W, 1% 0603	VISHAY, CRCW06031K24FKEA
33	1	R20	Sensor Res., 0.004Ω, 1W, 2%, RL3720W	Thin Film Tech., RL3720WT-R004-G-C
34	1	R21	RES., CHIP, 121k, 0.1W, 1% 0603	VISHAY, CRCW0603121K0FKEA
35	1	R24	RES., CHIP, 10k, 0.1W, 1% 0603	VISHAY, CRCW060310K0FKEA
36	1	R25	RES., CHIP, 0Ω, 0.125W, 0805	VISHAY, CRCW08050000Z0EA
37	1	R28	RES., CHIP, 5.6Ω, 1% 1206	VISHAY, CRCW12065R60FNEA
38	1	R29	RES., CHIP, 3.6Ω, 1% 1206	VISHAY, CRCW12063R60FNEA
39	1	R30	RES., CHIP, 33.2k, 0.1W, 1% 0603	VISHAY, CRCW060333K2FKEA
40	1	R31	RES., CHIP, 12.1k, 0.1W, 1% 0603	VISHAY, CRCW060312K1FKEA
41	1	U1	I.C., VOLT. REG.	Linear Tech. Corp.LTC3789EGN

dc1523af

## PARTS LIST

ITEM	QTY	REFERENCE	PART DESCRIPTION	MANUFACTURER/PART NUMBER
<b>Additional Demo Board Circuit Components</b>				
42	0	C3, C23, C26, C27 OPT	CAP., 1210	
43	1	CIN2	CAP., Alum, OPT	
44	0	CF1, C11, CF, C7, C8 OPT	CAP., 0603	
45	0	COU2 OPT		
46	0	Q6 OPT	Dual N-CHAN., Si7948DP, 60V	
47	0	Q7 OPT	Dual N-CHAN., Si7958DP, 40V	
48	0	R6, R12, R22, R27 OPT	RES., OPT	
<b>Hardware for Demo Board Only</b>				
49	4	TP1, TP2, TP3, TP7	TESTPOINT, TURRET, 0.061" PBF	MILL-MAX, 2308-2-00-80-00-00-07-0
50	7	TP4-TP6, TP8, TP10-TP12	TESTPOINT, TURRET, 0.094" PBF	MILL-MAX, 2501-2-00-80-00-00-07-0
51	1	JP1	3-PIN 0.079 SINGLE ROW HEADER	SAMTEC, TMM103-02-L-S
52	2	JP2C, JP2B	2-PIN 0.079 SINGLE ROW HEADER	SAMTEC, TMM102-02-L-S
53	2	XJP1, XJP2B	SHUNT, 0.079" CENTER	SAMTEC, 2SN-BK-G
54	4	J1, J2, J3, J4	CONNECTOR, BANANA JACK	KEYSTONE, 575-4
55	4	(STAND-OFF)	STAND-OFF, NYLON 0.25"	KEYSTONE, 8831(SNAP ON)

# DEMO MANUAL DC1523A

## SCHEMATIC DIAGRAMS

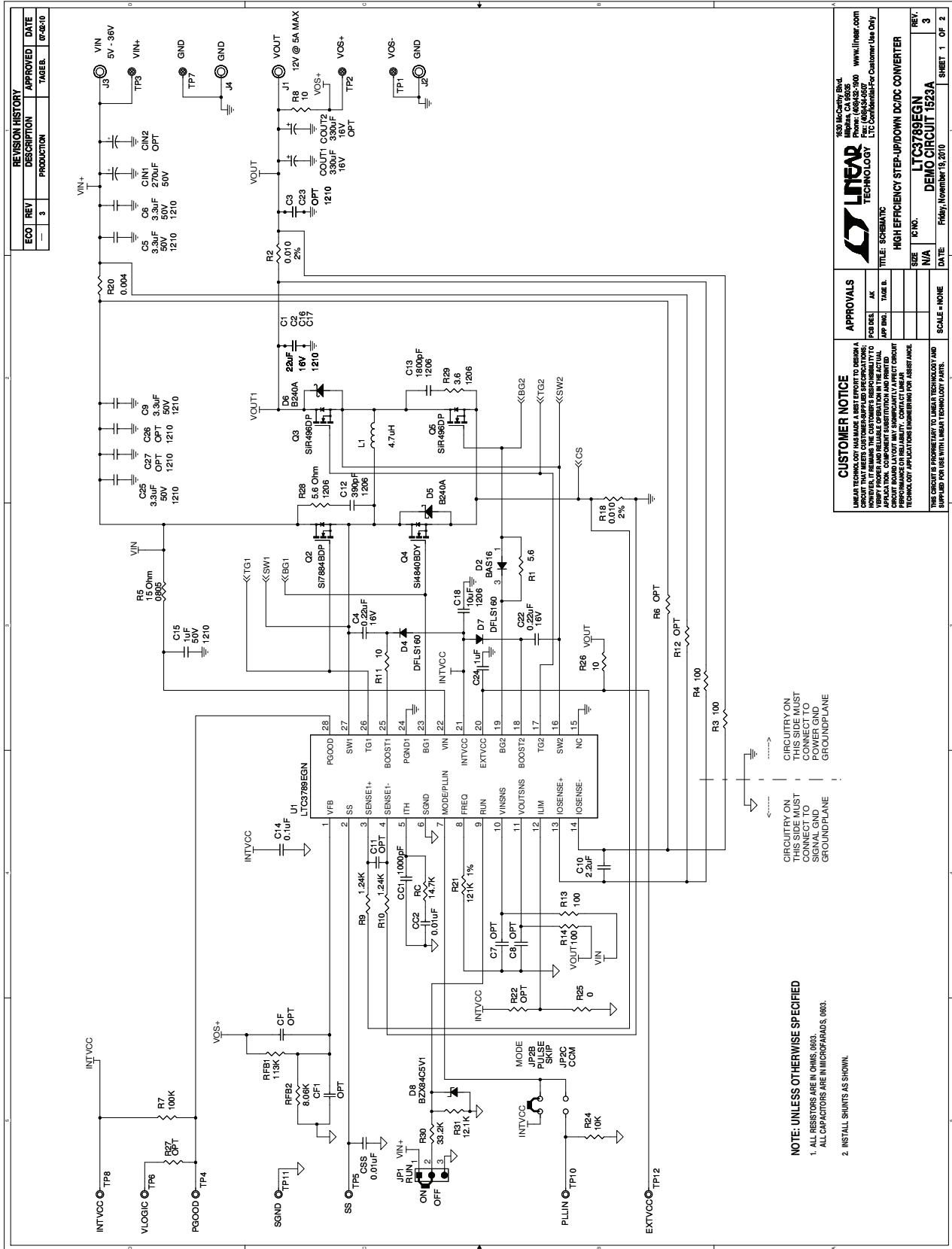



# DEMO MANUAL DC1523A

---

## DEMONSTRATION BOARD IMPORTANT NOTICE

Linear Technology Corporation (LTC) provides the enclosed product(s) under the following **AS IS** conditions:

This demonstration board (DEMO BOARD) kit being sold or provided by Linear Technology is intended for use for **ENGINEERING DEVELOPMENT OR EVALUATION PURPOSES ONLY** and is not provided by LTC for commercial use. As such, the DEMO BOARD herein may not be complete in terms of required design-, marketing-, and/or manufacturing-related protective considerations, including but not limited to product safety measures typically found in finished commercial goods. As a prototype, this product does not fall within the scope of the European Union directive on electromagnetic compatibility and therefore may or may not meet the technical requirements of the directive, or other regulations.

If this evaluation kit does not meet the specifications recited in the DEMO BOARD manual the kit may be returned within 30 days from the date of delivery for a full refund. **THE FOREGOING WARRANTY IS THE EXCLUSIVE WARRANTY MADE BY THE SELLER TO BUYER AND IS IN LIEU OF ALL OTHER WARRANTIES, EXPRESSED, IMPLIED, OR STATUTORY, INCLUDING ANY WARRANTY OF MERCHANTABILITY OR FITNESS FOR ANY PARTICULAR PURPOSE. EXCEPT TO THE EXTENT OF THIS INDEMNITY, NEITHER PARTY SHALL BE LIABLE TO THE OTHER FOR ANY INDIRECT, SPECIAL, INCIDENTAL, OR CONSEQUENTIAL DAMAGES.**

The user assumes all responsibility and liability for proper and safe handling of the goods. Further, the user releases LTC from all claims arising from the handling or use of the goods. Due to the open construction of the product, it is the user's responsibility to take any and all appropriate precautions with regard to electrostatic discharge. Also be aware that the products herein may not be regulatory compliant or agency certified (FCC, UL, CE, etc.).

No License is granted under any patent right or other intellectual property whatsoever. **LTC assumes no liability for applications assistance, customer product design, software performance, or infringement of patents or any other intellectual property rights of any kind.**

LTC currently services a variety of customers for products around the world, and therefore this transaction **is not exclusive**.

**Please read the DEMO BOARD manual prior to handling the product.** Persons handling this product must have electronics training and observe good laboratory practice standards. **Common sense is encouraged.**

This notice contains important safety information about temperatures and voltages. For further safety concerns, please contact a LTC application engineer.

Mailing Address:

Linear Technology  
1630 McCarthy Blvd.  
Milpitas, CA 95035

Copyright © 2004, Linear Technology Corporation