

LOC	DIST	REVISIONS					
E	B	P	LTR	DESCRIPTION	DATE	DWN	APVD
			BA	NEW RELEASE	03-NOV-08	SM	St.P

FOR FURTHER INFORMATION SEE DATA SHEET FOR  
CRG SERIES-THICK FILM CHIP RESISTORS

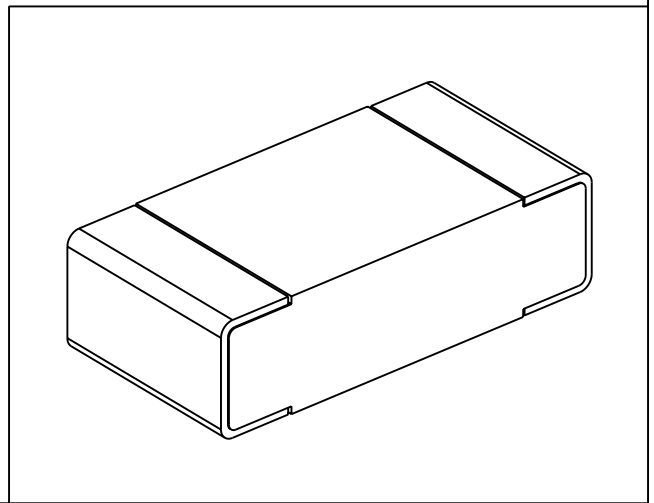
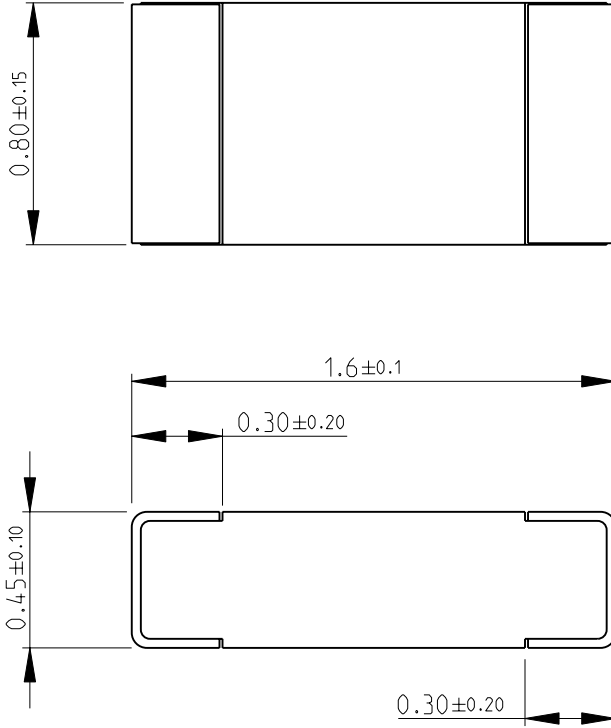

RoHS Compliant

2008

RELEASED FOR PUBLICATION

THIS DRAWING IS UNPUBLISHED.

© COPYRIGHT 2008 BY TYCO ELECTRONICS CORPORATION. ALL RIGHTS RESERVED.

DIMENSIONS: mm	DWN	SUBHASH.M	03-NOV-08	MATERIAL	-	FINISH	-	
	CHK	PRAKASH.S	03-NOV-08	Tyco Electronics Corporation Dorcan, Swindon, SN3 5HH				
TOLERANCES UNLESS OTHERWISE SPECIFIED:	APVD	STEPHEN.P	03-NOV-08					
0 PLC ±0.5	PRODUCT SPEC	-	NAME THICK FILM CHIP RESISTORS					
1 PLC ±0.2	APPLICATION SPEC	-	SERIES CRG 0603					
2 PLC ±0.1	WEIGHT	-	SIZE	CAGE CODE	DRAWING NO	RESTRICTED TO		
3 PLC ±-			A 4	00779	© = 1622855	-		
4 PLC ±-			CUSTOMER DRAWING				SCALE	40:1
ANGLES ±5°							SHEET	1 OF 1
							REV	BA