



# MAX2264/MAX2265/MAX2266 Evaluation Kits

## General Description

The MAX2264/MAX2265/MAX2266 evaluation kits (EV kits) simplify evaluation of the MAX2264/MAX2265/MAX2266 power amplifiers (PAs), which are designed for operation in IS-98-based CDMA, IS-136-based TDMA, and PDC cellular phones operating in the 900MHz range. The kits enable testing of the devices' RF performance and require no additional support circuitry. The EV kits' signal inputs and outputs use SMA connectors to facilitate the connection of RF test equipment.

Each kit is assembled with either the MAX2264, MAX2265 or MAX2266 and incorporates input and output matching components optimized for the 824MHz to 849MHz RF frequency band. These EV kits are capable of operating at RF frequencies from 750MHz to 1000MHz with the appropriate matching components.

## Features

- ◆ Easy Evaluation of MAX2264/MAX2265/MAX2266
- ◆ +2.7V to +5V Single-Supply Operation
- ◆ RF Input/Output Matched for 824MHz to 849MHz Operation
- ◆ All Matching Components Included

## Ordering Information

PART	TEMP. RANGE	IC PACKAGE
MAX2264EVKIT	-40°C to +85°C	16 TSSOP-EP*
MAX2265EVKIT	-40°C to +85°C	16 TSSOP-EP*
MAX2266EVKIT	-40°C to +85°C	16 TSSOP-EP*

\*Exposed Paddle

## MAX2264 EV Kit Component List

DESIGNATION	QTY	DESCRIPTION
C1	1	6.2pF $\pm 0.25$ pF ceramic capacitor (0603) Murata GRM39COG6R2C50
C2, C4, C6, C7, C9, C14, C17	7	100pF $\pm 5\%$ ceramic capacitors (0402) Murata GRM36COG101J50 or Taiyo Yuden UMK105CH101JW
C3, C5, C8, C13, C16	5	0.01 $\mu$ F $\pm 5\%$ ceramic capacitors (0402) Murata GRM36X7R103J16 or Taiyo Yuden EMK105B103KW
C10	1	5.1pF $\pm 0.1$ pF porcelain capacitor ATC 100A5R1BW150X
C11	1	10pF $\pm 0.1$ pF porcelain capacitor ATC 100A100FW150X Mounted with top side aligned six tick marks from the zero tick mark (ruler located to the right of C11; see Figure 3)
C12	1	4.7pF $\pm 0.1$ pF ceramic capacitor (0402) Murata GRM39COG4R7B50V
C15	0	Not installed
C18	1	220pF $\pm 5\%$ ceramic capacitor (0603) Murata GRM39COG221J050
C19	1	10 $\mu$ F $\pm 20\%$ , 16V tantalum capacitor AVX TAJB106M016
C20	1	0.01 $\mu$ F $\pm 5\%$ ceramic capacitor (0603) Murata GRM39X7R103J50
C21	1	100pF $\pm 5\%$ ceramic capacitor (0603) Murata GRM39COG101J50
C22–C25	4	0.1 $\mu$ F $\pm 10\%$ ceramic capacitors (0603) Murata GRM39X7R104K50V or Taiyo Yuden EMK107BJ104KA

DESIGNATION	QTY	DESCRIPTION
C26	1	470pF $\pm 5\%$ ceramic capacitor (0603) Murata GRM39COHG471J50
GND, VCC	2	Test points
IN, OUT	2	SMA connectors (PC edge mount) EF Johnson 142-0701-801
JU1, JU2	2	3-pin headers
L1	1	3.9nH $\pm 0.3$ nH inductor (0603) Murata LQG11A3N9S00
L2	1	5.6nH $\pm 2\%$ inductor Coilcraft 1606-6G
L3	1	12nH $\pm 5\%$ inductor (0603) Murata LQG11A12NJ00
L4	1	39nH $\pm 5\%$ inductor (0603) Murata LQG11A39NJ00
L5	1	1.2nH $\pm 0.3$ nH inductor (0603) Murata LQG11A1N2S00
Q1	1	0 $\Omega$ resistor (0805)
R1, R3	2	51k $\Omega$ $\pm 5\%$ resistors (0603)
R2	1	30.1k $\Omega$ $\pm 1\%$ resistor (0603)
R4	1	7.5k $\Omega$ $\pm 1\%$ resistor (0603)
R5	1	24.3k $\Omega$ $\pm 1\%$ resistor (0603)
R7	1	33.2k $\Omega$ $\pm 1\%$ resistor (0603)
R8, R9, R10	3	0 $\Omega$ resistors (0603)
U1	1	MAX2264EUE (16-pin TSSOP-EP)
None	2	Shunts (JU1, JU2)
None	1	MAX226X PC board
None	1	MAX2264/5/6 data sheet
None	1	MAX2264/5/6 EV kits data sheet

Evaluate: MAX2264/MAX2265/MAX2266



# MAX2264/MAX2265/MAX2266 Evaluation Kits

**Evaluate: MAX2264/MAX2265/MAX2266**

## MAX2265 EV Kit Component List

DESIGNATION	QTY	DESCRIPTION
C1	1	5.1pF ±0.25pF ceramic capacitor (0603) Murata GRM39COG5R1C050
C2, C4, C6, C7, C9	5	100pF ±5% ceramic capacitors (0402) Murata GRM36COG101J50 or Taiyo Yuden UMK105CH101JW
C3, C5, C8	3	0.01µF ±5% ceramic capacitors (0402) Murata GRM36X7R103J16 or Taiyo Yuden EMK105B103KW
C10	1	0.01µF ±20% high-Q ceramic capacitor ATC 200A103MW50
C11	1	9.1pF ±0.1pF porcelain capacitor ATC 100A9R1BW150X
C12–C18, C24, C25	0	Not installed
C19	1	10µF ±20%, 16V tantalum capacitor AVX TAJB106M016
C20	1	0.01µF ±5% ceramic capacitor (0603) Murata GRM39X7R103J50
C21	1	100pF ±5% ceramic capacitor (0603) Murata GRM39COG101J50
C22, C23	2	0.1µF ±10% ceramic capacitors (0603) Murata GRM39X7R104K50V or Taiyo Yuden EMK107BJ104KA
C26	1	470pF ±5% ceramic capacitor (0603) Murata GRM39COG471J50
C27	1	3.3pF ±5% ceramic capacitor (0402) Murata GRM36COG220J050 or Taiyo Yuden UMK105CH220JW

DESIGNATION	QTY	DESCRIPTION
GND, VCC	2	Test points Mouser 151-203
IN, OUT	2	SMA connectors (PC edge mount) EF Johnson 142-0701-801
JU1, JU2	2	3-pin headers
L1	1	5.6nH ±0.3nH inductor (0603) Murata LQG11A5N6S00
L2	1	5.6nH ±2% inductor Coilcraft 1606-6G
L3, L5	0	Not installed
L4	1	39nH ±5% inductor (0603) Murata LQG11A39NJ00
L6	1	2.2nH ±0.3nH inductor (0603) Coilcraft 0402CS-2N2XJBG
Q1, R4, R5	0	Not installed
R1, R3	2	51kΩ ±5% resistors (0603)
R2	1	35.7kΩ ±1% resistor (0603)
R7	1	33.2kΩ ±1% resistor (0603)
R9, R10	2	0Ω resistors (0603)
U1	1	MAX2265EUE (16-pin TSSOP-EP)
None	2	Shunts (JU1, JU2)
None	1	MAX226X PC board
None	1	MAX2264/5/6 data sheet
None	1	MAX2264/5/6 EV kits data sheet

## Component Suppliers

SUPPLIER	PHONE	FAX	WEB
ATC	516-622-4700	516-622-4748	www.atceramics.com
AVX	803-946-0690	803-626-3123	www.avx-corp.com
Coilcraft	847-639-6400	847-639-1469	www.coilcraft.com
EF Johnson	402-474-4800	402-474-4858	www.efjohnson.com
Kamaya	219-489-1533	219-489-2261	www.kamaya.com
Murata Electronics	800-831-9172	814-238-0490	www.murata.com
NEC	408-243-2111	408-243-2410	www.cel.com
ROHM	408-433-2225	408-434-0531	www.rohm.com
Taiyo Yuden	408-573-4150	408-573-4159	www.t-yuden.com

# MAX2264/MAX2265/MAX2266 Evaluation Kits

## MAX2266 EV Kit Component List

DESIGNATION	QTY	DESCRIPTION
C1	1	6.2pF $\pm 0.25$ pF ceramic capacitor (0603) Murata GRM39COG6R2C50
C2, C4, C6, C7, C9, C14, C17	7	100pF $\pm 5\%$ ceramic capacitors (0402) Murata GRM36COG101J50 or Taiyo Yuden UMK105CH101JW
C3, C5, C8, C13, C16	5	0.01 $\mu$ F $\pm 5\%$ ceramic capacitors (0402) Murata GRM36X7R103J16 or Taiyo Yuden EMK105B103KW
C10	1	3.9pF $\pm 0.1$ pF porcelain capacitor ATC 100A3R9BW150X
C11	1	7.5pF $\pm 0.1$ pF porcelain capacitor ATC 100A7R5FW150X Mounted with top side aligned six tick marks from the zero tick mark (ruler loc- ated to the right of C11; see Figure 3)
C12	1	5.1pF $\pm 0.1$ pF ceramic capacitor (0402) Murata GRM39COG5R1B50V
C15, C27–C30	0	Not installed
C18	1	220pF $\pm 5\%$ ceramic capacitor (0603) Murata GRM39COG221J050
C19	1	10 $\mu$ F $\pm 20\%$ , 16V tantalum capacitor AVX TAJB106M016
C20	1	0.01 $\mu$ F $\pm 5\%$ ceramic capacitor (0603) Murata GRM39X7R103J50
C21	1	100pF $\pm 5\%$ ceramic capacitor (0603) Murata GRM39COG101J50
C22–C25	4	0.1 $\mu$ F $\pm 10\%$ ceramic capacitors (0603) Murata GRM39X7R104K50V or Taiyo Yuden EMK107BJ104KA
C26	1	470pF $\pm 5\%$ ceramic capacitor (0603) Murata GRM39COHG471J50
GND, VCC	2	Test points

DESIGNATION	QTY	DESCRIPTION
IN, OUT	2	SMA connectors (PC edge mount) EF Johnson 142-0701-801
JU1, JU2	2	3-pin headers
L1	1	3.9nH $\pm 0.3$ nH inductor (0603) Murata LQG11A3N9S00
L2	1	5.6nH $\pm 2\%$ inductor Coilcraft 1606-6G
L3	1	4.7nH $\pm 5\%$ inductor (0603) Murata LQG11A4N7J00
L4	1	39nH $\pm 5\%$ inductor (0603) Murata LQG11A39NJ00
L5	1	1.2nH $\pm 0.3$ nH inductor (0603) Murata LQG11A1N2S00
L6	1	100nH $\pm 5\%$ inductor (0603) Murata LQG11AR10J00
Q2	1	Open collector inverter ROHM DTC143ZE
R1, R3	2	51k $\Omega$ $\pm 5\%$ resistors (0603)
R2	1	26.1k $\Omega$ $\pm 1\%$ resistor (0603)
R4	1	7.5k $\Omega$ $\pm 1\%$ resistor (0603)
R5	1	24.3k $\Omega$ $\pm 1\%$ resistor (0603)
R6	1	10k $\Omega$ $\pm 5\%$ resistor (0603)
R7	1	33.2k $\Omega$ $\pm 1\%$ resistor (0603)
R8, R9, R10	3	0 $\Omega$ resistors (0603)
R11	1	510 $\Omega$ $\pm 5\%$ resistor (0603)
U1	1	MAX2266EUE (16-pin TSSOP-EP)
U2	1	NEC UPG152TA
None	2	Shunts (JU1, JU2)
None	1	MAX226Z PC board
None	1	MAX2264/5/6 data sheet
None	1	MAX2264/5/6 EV kits data sheet

**Evaluate: MAX2264/MAX2265/MAX2266**

# MAX2264/MAX2265/MAX2266 Evaluation Kits

## Quick Start

The MAX2264/MAX2265/MAX2266 EV kits are fully assembled and factory tested. Follow the instructions in the *Connections and Setup* section for proper device evaluation.

## Test Equipment Required

This section lists the test equipment recommended to verify operation of the MAX2264/MAX2265/MAX2266. It is intended as a guide only, and some substitutions are possible.

- An RF signal generator capable of delivering at least +10dBm of output power at the operating frequency with CDMA modulation (HP E4433G or equivalent)
- An RF power sensor capable of handling at least +20dBm of output power at the operating frequency (HP 8482A, or equivalent)
- A 20dB high-power attenuator
- An RF power meter capable of measuring up to +20dBm of output power at the operating frequency (HP EPM-441A or equivalent)
- An RF spectrum analyzer capable of measuring ACPR and covering the MAX2264/MAX2265/MAX2266's operating frequency range (Rhodes at Schwartz FSEA20, for example)
- A power supply capable of up to 1A at +2.7V to +5V
- A high-impedance voltmeter for measuring the actual operating voltage
- An ammeter for measuring the supply current (optional)
- Two 50Ω SMA cables
- A network analyzer (HP 8753D, for example) to measure small-signal return loss and gain (optional)

## Connections and Setup

This section provides a step-by-step guide to operating the EV kits and testing the devices' functions. Do not turn on the DC power or RF signal generator until all connections are made.

- 1) Connect a 20dB high-power attenuator to the OUT SMA connector on the EV kit. This will prevent overloading the power sensor and the power meter.
- 2) Connect a DC supply set to +3.3V (through an ammeter if desired), and connect the voltmeter to the EV kit's VCC and GND terminals.
- 3) Connect an RF signal generator to the IN SMA connector. Set the generator for an 836MHz output frequency at a 0dBm power level.
- 4) Connect the power sensor to the power meter. Calibrate the power sensor for 836MHz. Set the power meter offset to compensate the 20dB attenuator plus any cable loss (between 0.5dB and 2dB), and circuit board losses (approximately 0.1dB).
- 5) Connect a power sensor to the 20dB high-power attenuator.
- 6) Place the HIGH/LOW jumper (JU1) in the HIGH position and the ON/OFF jumper (JU2) in the ON position.
- 7) Turn on the DC supply. The supply current should read approximately 80mA to 90mA.
- 8) Activate the RF generator's output. Set the RF generator's output to produce a reading of +28dBm on the power meter. Verify that the voltmeter reads +3.3V. Iteratively adjust the power supply's output and the RF generator's output to produce a +3.3V reading on the voltmeter and a reading of 28dBm on the power meter.
  - a) For the MAX2264, the supply current should increase to approximately 580mA.
  - b) For the MAX2265, the supply current should increase to approximately 520mA.
  - c) For the MAX2266, the supply current should increase to approximately 580mA.
- 9) For the MAX2264/MAX2266 EV kits:
  - a) Adjust the RF generator's output to -10dBm. Turn off the RF generator's output.
  - b) Place the HIGH/LOW jumper (JU1) in the LOW position.
  - c) The supply current reading should drop to approximately 34mA.
  - d) Activate the RF generator's output.
  - e) Adjust the RF generator's output for a +16.5dBm power meter reading. Iteratively adjust the power supply's output and the RF generator's output to produce a reading of +3.3V on the voltmeter and a +16.5dBm reading on the power meter. The supply current should increase to approximately 105mA/70mA (MAX2264/MAX2266).





# MAX2264/MAX2265/MAX2266 Evaluation Kits

Evaluate: MAX2264/MAX2265/MAX2266

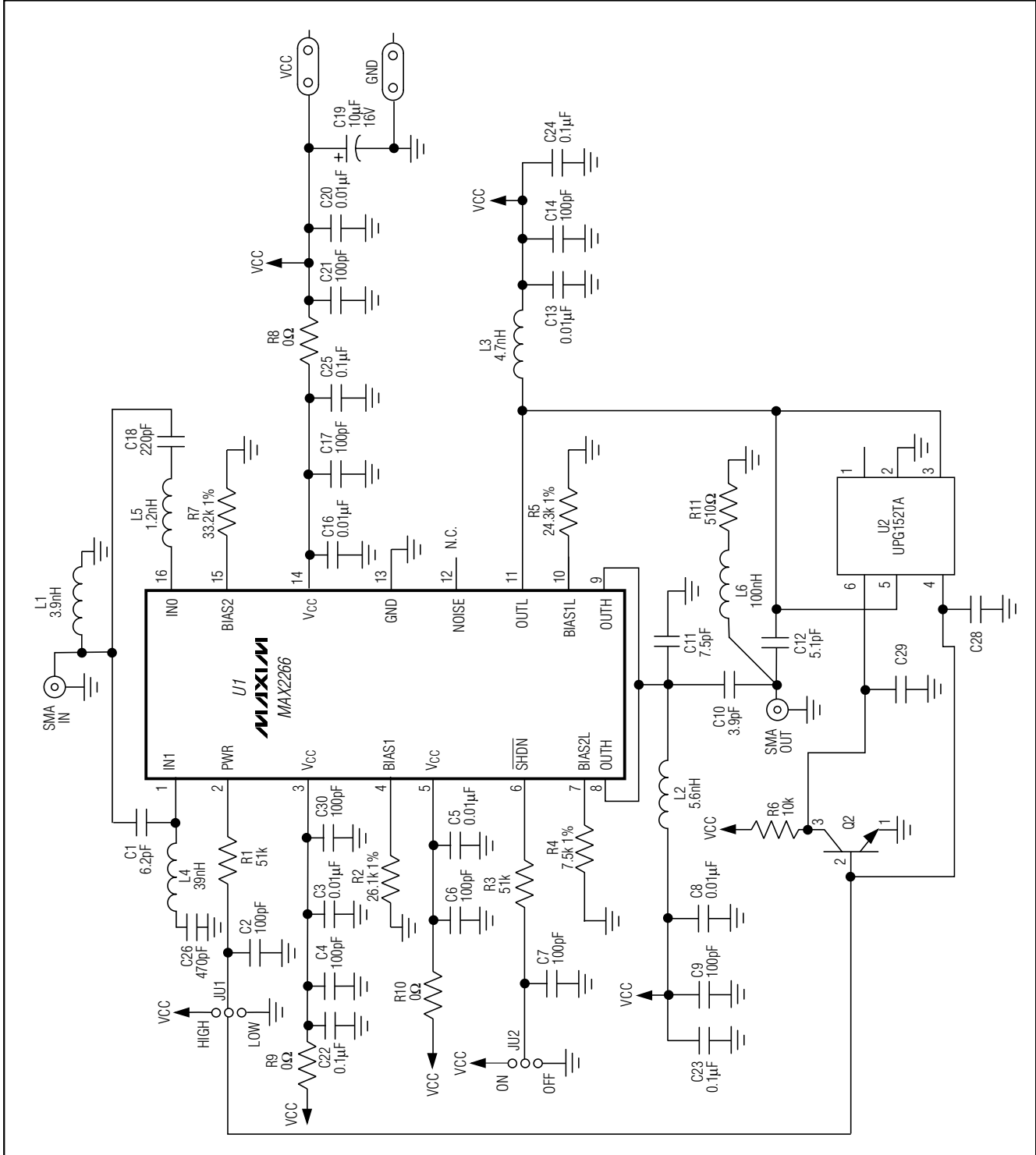

Figure 3. MAX2266 EV Kit Schematic

# MAX2264/MAX2265/MAX2266 Evaluation Kits

## Layout Issues

A good PC board is an essential part of an RF circuit design. The EV kit PC board can serve as a guide for laying out a board using the MAX2264/MAX2265/MAX2266. Keep traces carrying RF signals as short as possible to minimize radiation and insertion loss due to the PC board. Each VCC node on the PC board should have its own decoupling capacitor. This minimizes supply coupling from one section of the IC to another. Using a star topology for the supply layout, in which each VCC node on the circuit has a separate connection to a central VCC node, can further minimize coupling between sections of the IC.

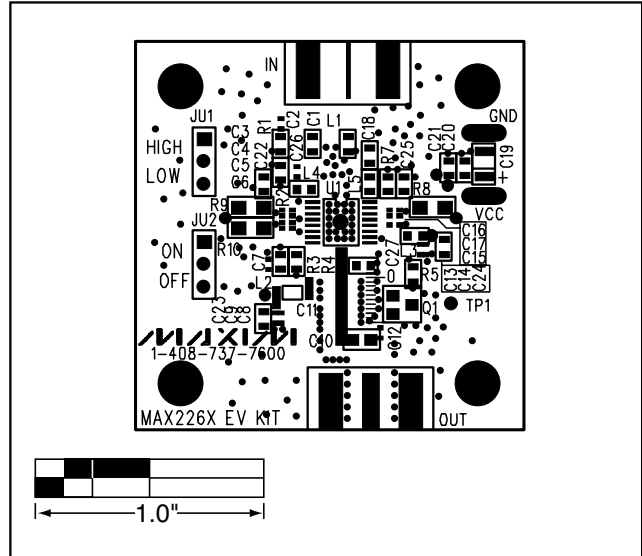

Figure 4. MAX2264/MAX2265 EV Kits—Component Placement Guide

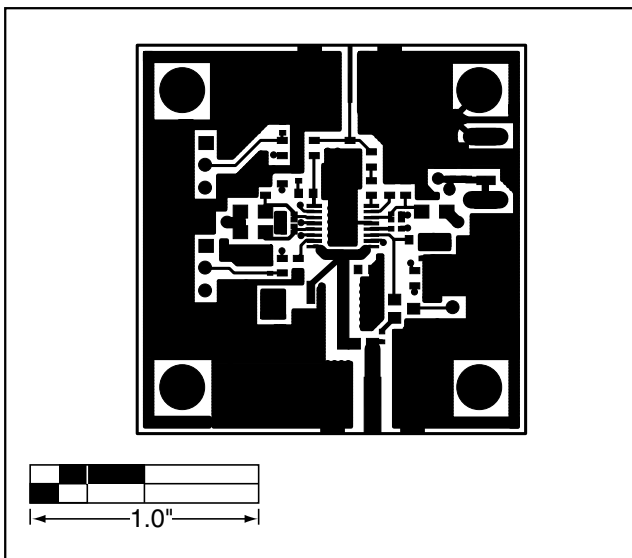

Figure 5. MAX2264/MAX2265 EV Kits PC Board Layout—Component Side

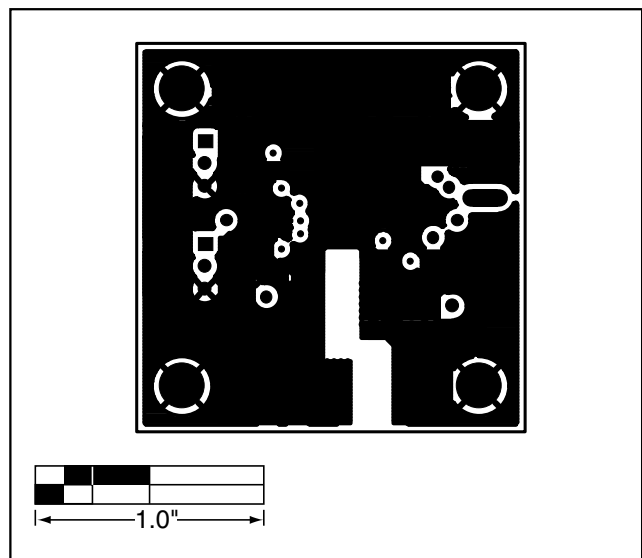

Figure 6. MAX2264/MAX2265 EV Kits PC Board Layout—Ground Plane



# MAX2264/MAX2265/MAX2266 Evaluation Kits

Evaluate: MAX2264/MAX2265/MAX2266

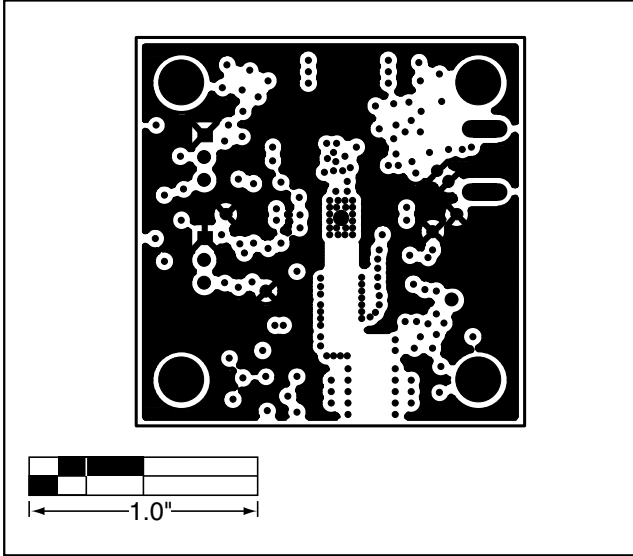

Figure 7. MAX2264/MAX2265 EV Kits PC Board Layout—Power Plane

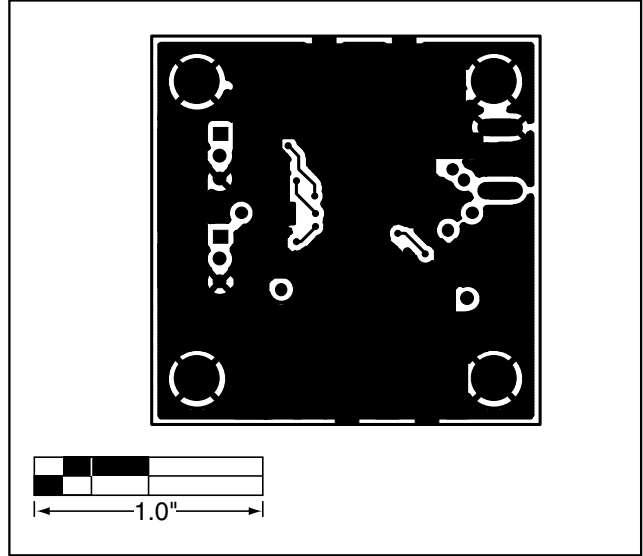

Figure 8. MAX2264/MAX2265 EV Kits PC Board Layout—Solder Side

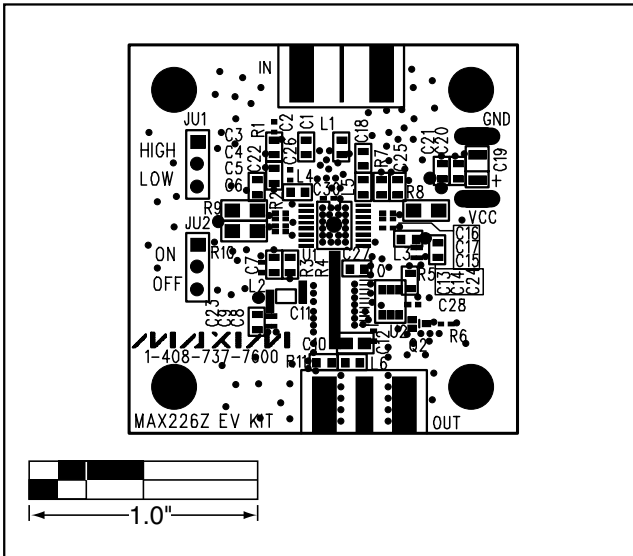

Figure 9. MAX2266 EV Kit—Component Placement Guide

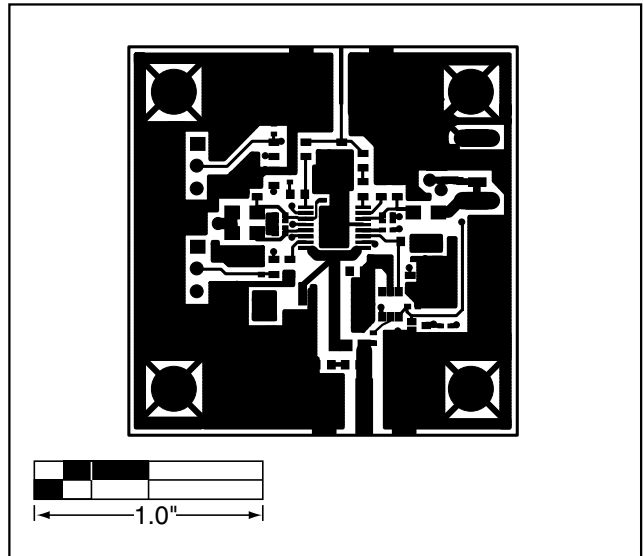

Figure 10. MAX2266 EV Kit PC Board Layout—Component Side

# MAX2264/MAX2265/MAX2266 Evaluation Kits

Evaluate: MAX2264/MAX2265/MAX2266

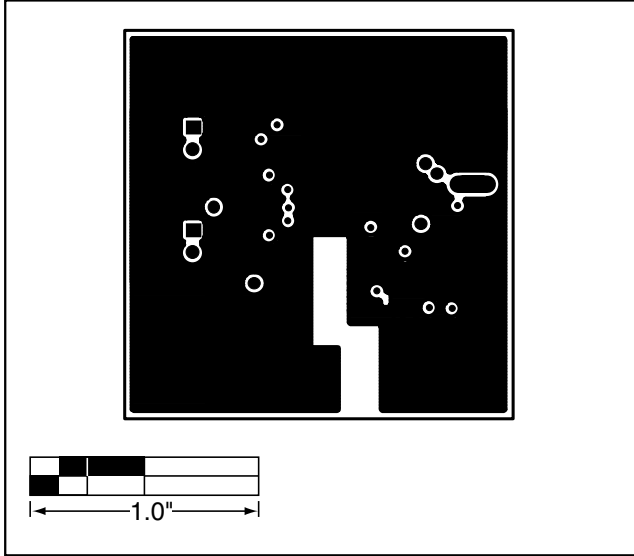

Figure 11. MAX2266 EV Kit PC Board Layout—Ground Plane

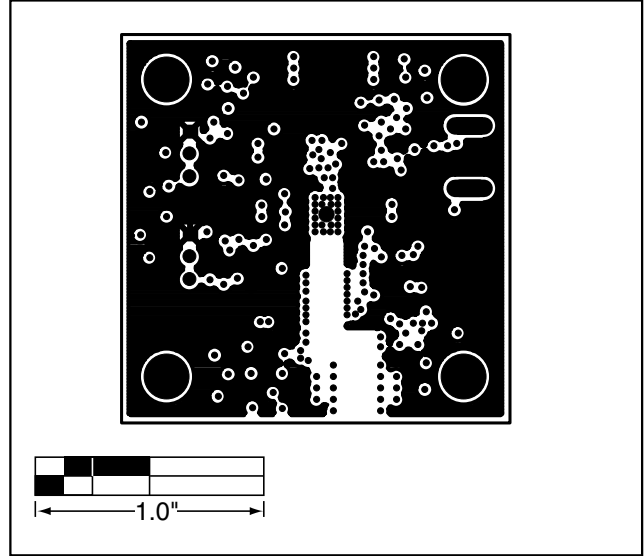

Figure 12. MAX2266 EV Kit PC Board Layout—Power Plane

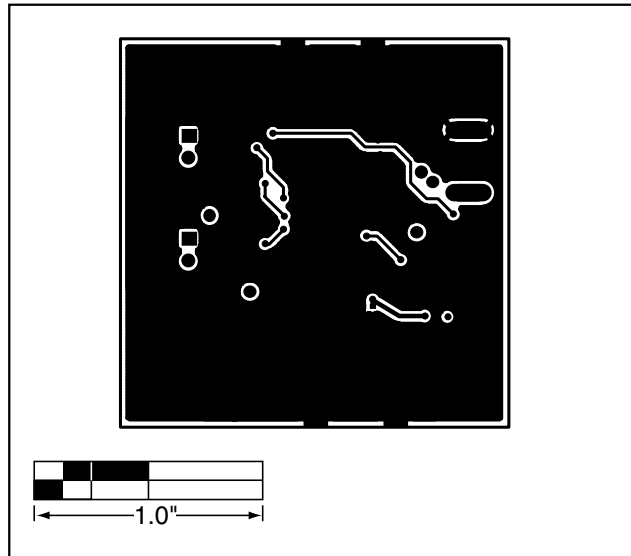

Figure 13. MAX2266 EV Kit PC Board Layout—Solder Side

# **MAX2264/MAX2265/MAX2266 Evaluation Kits**

NOTES

**Evaluate: MAX2264/MAX2265/MAX2266**

# **MAX2264/MAX2265/MAX2266 Evaluation Kits**

## **NOTES**

**Evaluate: MAX2264/MAX2265/MAX2266**

*Maxim cannot assume responsibility for use of any circuitry other than circuitry entirely embodied in a Maxim product. No circuit patent licenses are implied. Maxim reserves the right to change the circuitry and specifications without notice at any time.*

**12 \_\_\_\_\_ Maxim Integrated Products, 120 San Gabriel Drive, Sunnyvale, CA 94086 408-737-7600**