

THIS COPY IS PROVIDED ON A RESTRICTED BASIS AND IS NOT TO BE USED IN ANY WAY DETRIMENTAL TO THE INTERESTS OF PANDUIT CORP.

Material	High Conductivity Seamless Copper Tube
Plating	Electro-Tin
Wire Size	8 AWG
Wire Type	Stranded Copper; Class B: Compact, Compressed or Concentric, Class C: Concentric
Wire Strip Length	1/2 in.
Stud Size	5/16 in.
UL Listed Wire Connector	Yes, for applications up to 35kv. Consult cable manufacturer for voltage stress relief instructions with applications greater than 2000 volts.
UL Temperature Rating	90° C
C.S.A Certified Wire Connector	Yes
Panduit Color Code on Barrel	RED
Panduit Die Index No. on Barrel	P21
Alternate Industry Die Index No. () on Barrel	N/A

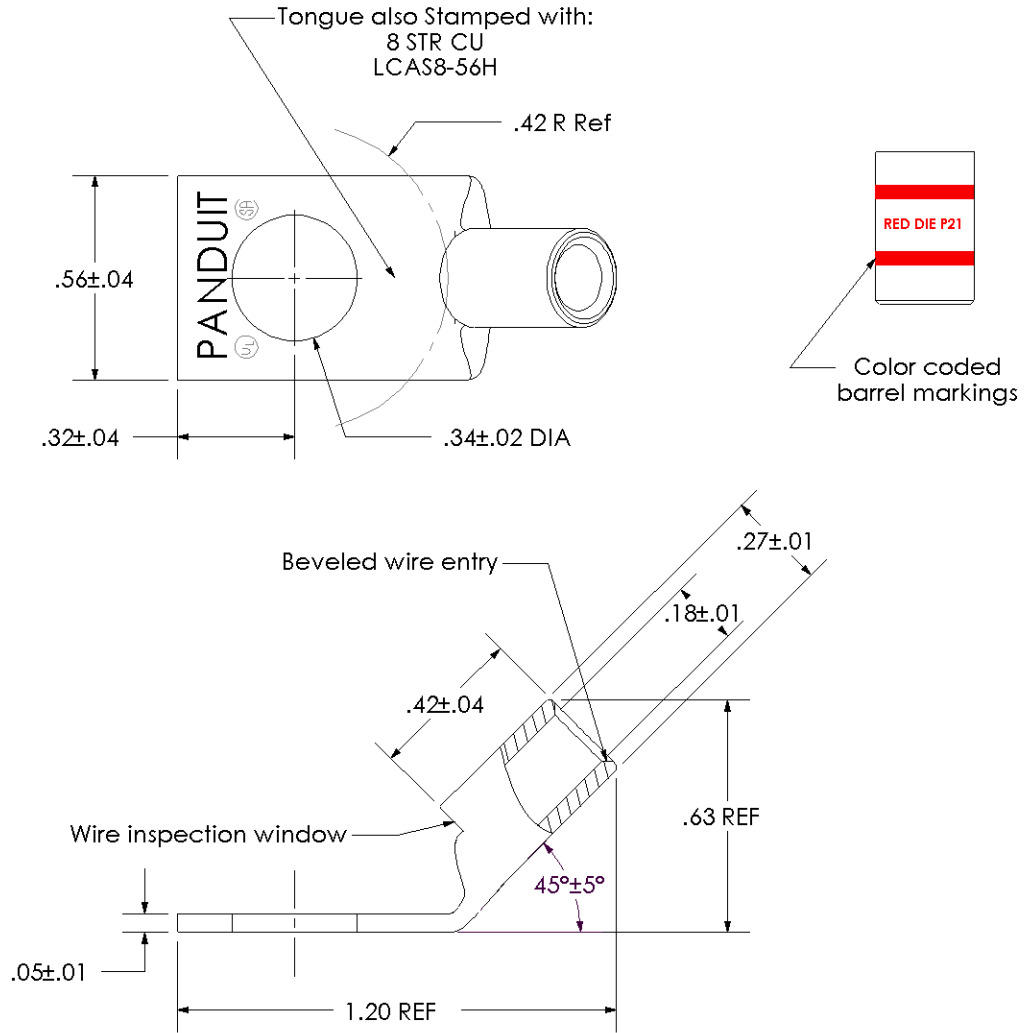

CERTIFIED



LISTED Wire Connector

01	4-03	PWS	PWS	REMOVED PANDUIT FROM BARREL MARKINGS	10790
REV	DATE	BY	CHK	DESCRIPTION	ECN

PANDUIT CORP. TINLEY PARK, ILLINOIS

LCAS8-56H-L
Copper Lug - One-Hole, Short Barrel, 45° Angle Tongue

SCALE N/A DRAWING NO / CAD FILE LCAS8-56H-CUST