

LOC		DIST		REVISIONS			
ES	00	P	LTN	DESCRIPTION	DATE	DWN	APVD
		E8		REV PER ECR-12-021802	04JAN2013	ML	SZ

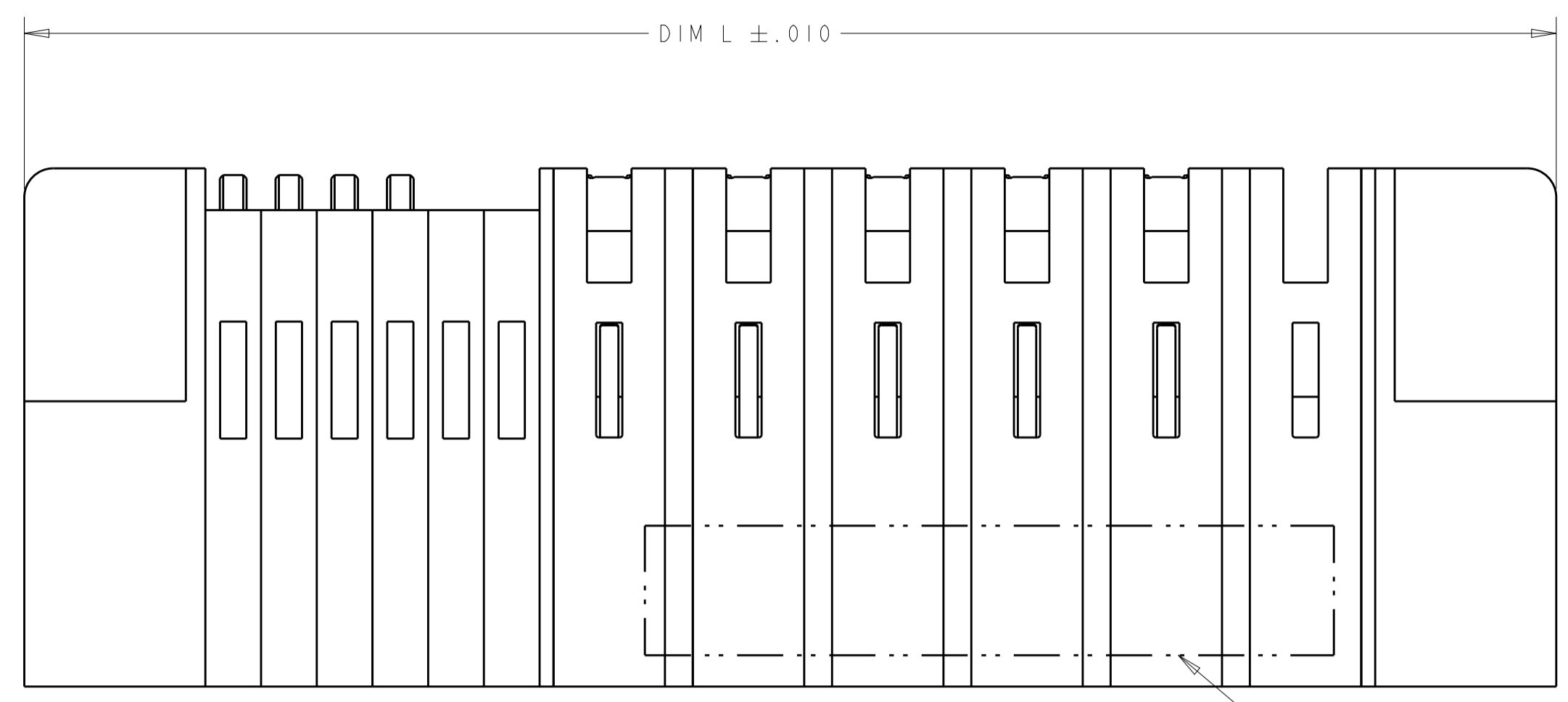

- ⚠ "AMP", PART NUMBER, AND DATE CODE TO BE MARKED IN AREA SHOWN.
- ⚠ MATERIAL: HOUSING - GLASS FILLED HIGH TEMP THERMO PLASTIC, UL94 V-0
 SIGNAL CONTACT - COPPER ALLOY
 POWER CONTACT - HIGH CONDUCTIVITY COPPER ALLOY
- ⚠ CONTACT PLATING: NOBLE METAL PLATING ON CONTACT FUNCTIONAL AREA OF POWER CONTACTS AND SIGNAL CONTACTS.
- ⚠ MECHANICAL CONNECTOR KEEP OUT ZONE.
- ⚠ DATUM AND BASIC DIMENSIONS ESTABLISHED BY CUSTOMER.
- ⚠ PCB - ALL HOLE DIAMETERS ARE FINISHED HOLE SIZES.
- ⚠ PCB - .0453±.0010 DRILLED HOLES PLATED WITH .0003 MIN Sn OVER .001 TO .003 CU PLATING TO ACHIEVE A .040±.003 DIA HOLE

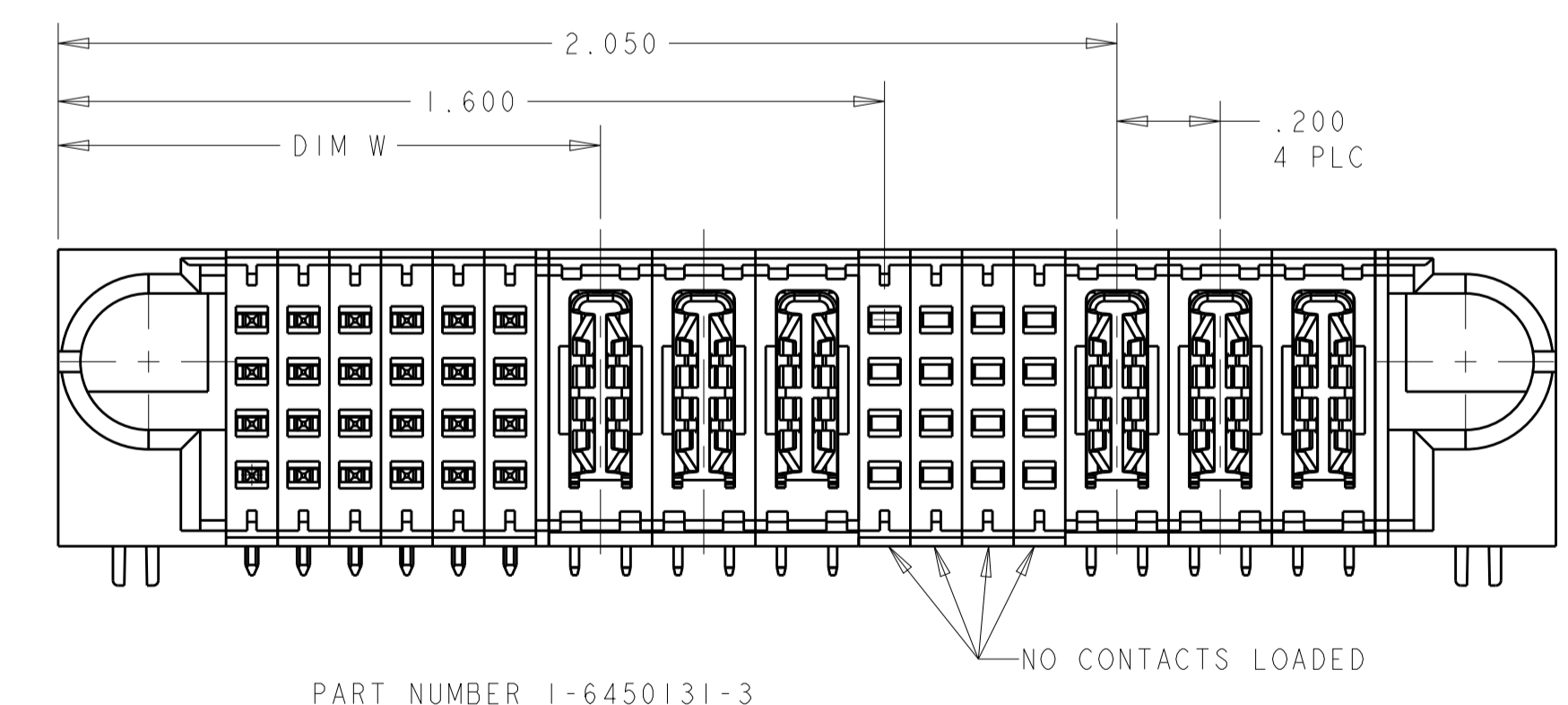
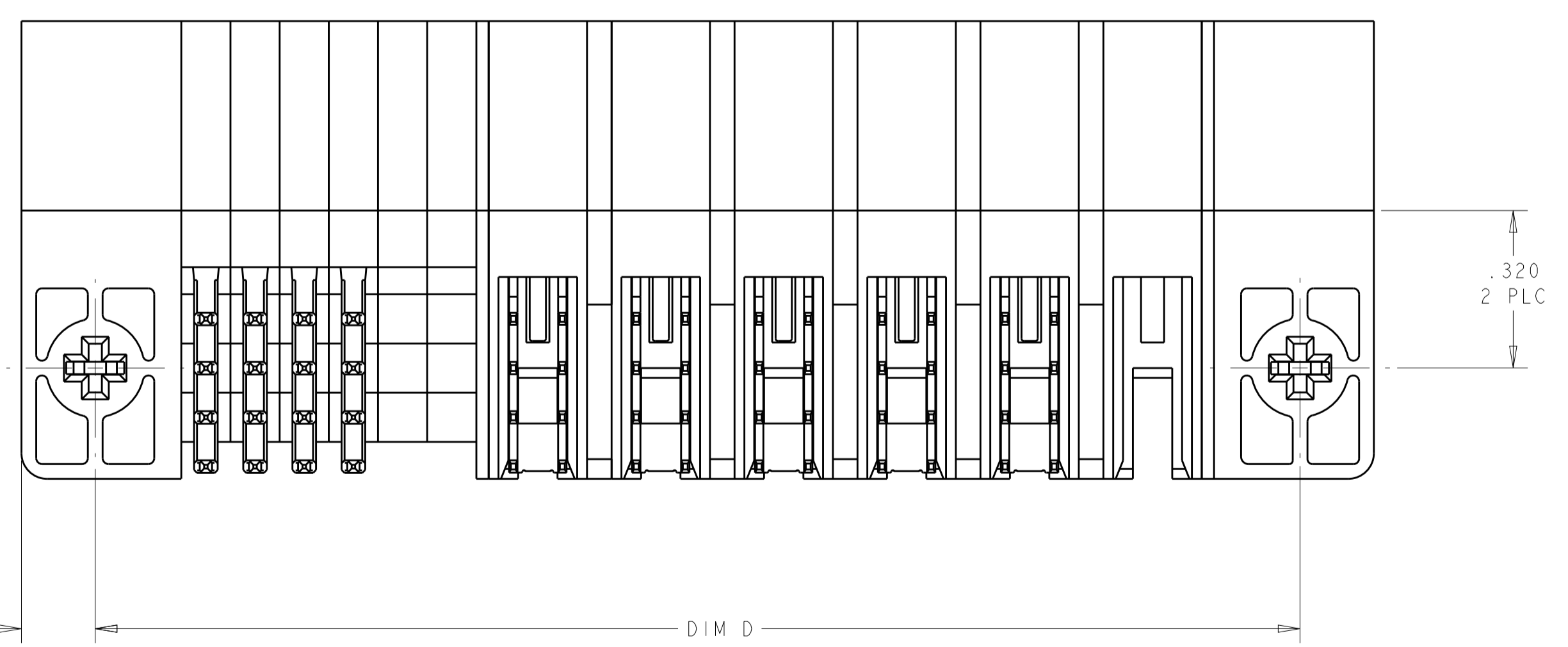
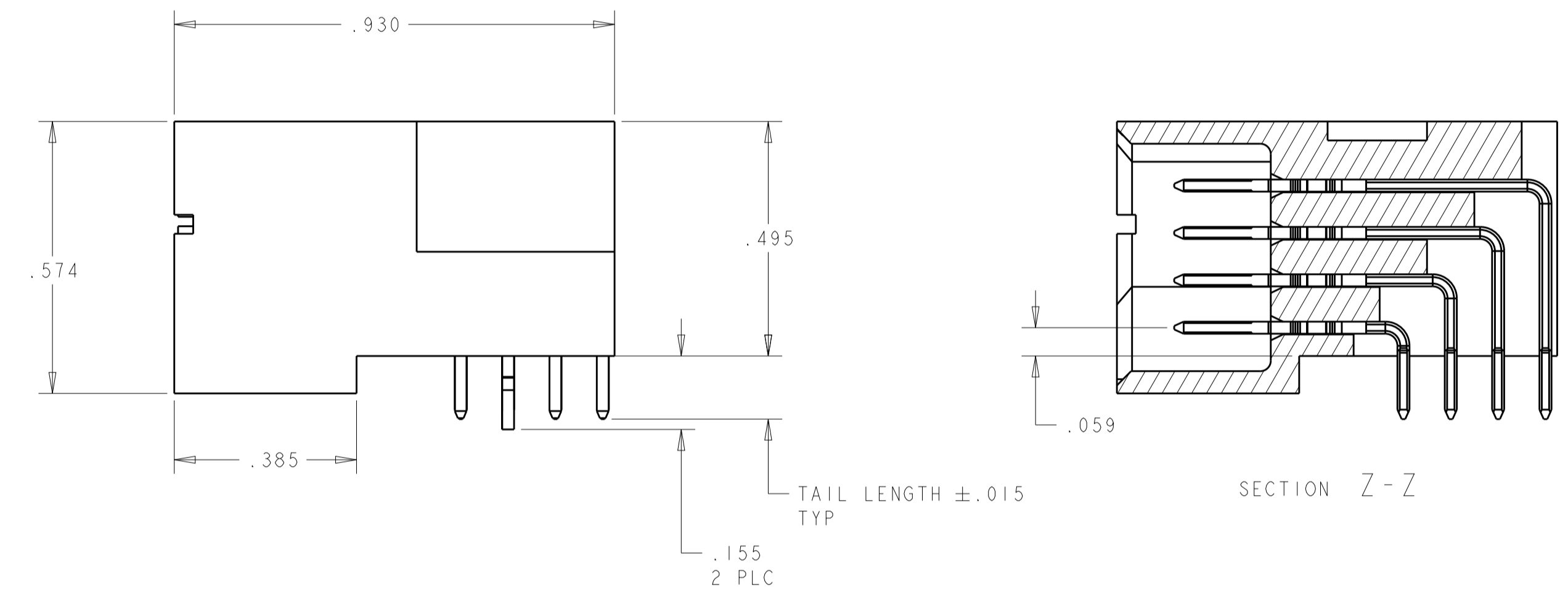
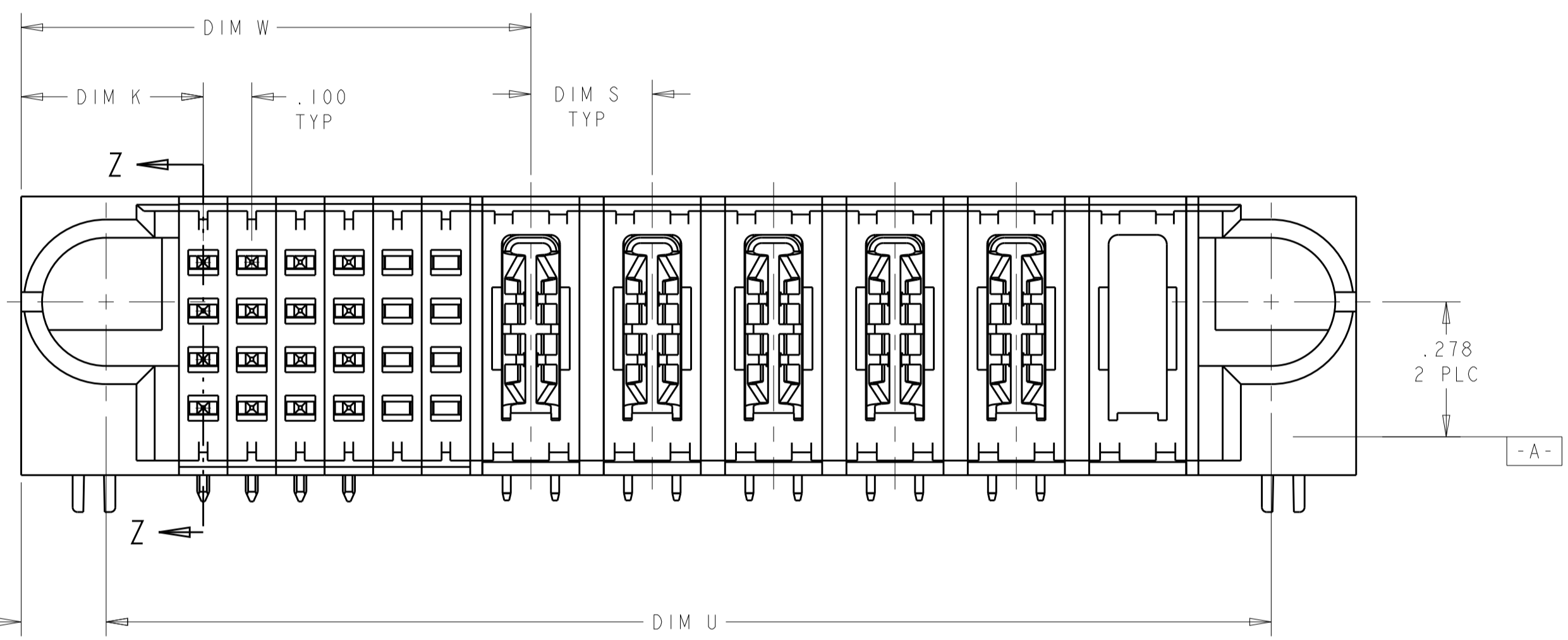

PART NUMBER I-6450131-3

THIS DRAWING IS A CONTROLLED DOCUMENT.		DWN R. GRZYBOWSKI CHK M. PERCHERKE	15FEB05 15FEB05	TE Connectivity
DIMENSIONS: INCHES TOLERANCES UNLESS OTHERWISE SPECIFIED: 0 PLC ±. 1 PLC ±.01 2 PLC ±.005 3 PLC ±.002 4 PLC ±.0020 ANGLES ±.2° FINISH: ⚠		APVD M. PERCHERKE PRODUCT SPEC 108-1973 APPLICATION SPEC 114-13038 WEIGHT CUSTOMER DRAWING		
SCALE 2:1 SHEET 1 OF 8 REV E8				RESTRICTED TO

LOC	DIST	REVISIONS					
		P	LTN	DESCRIPTION	DATE	DMN	APVD
ES	00	-	-	SEE SHEET 1	-	-	-

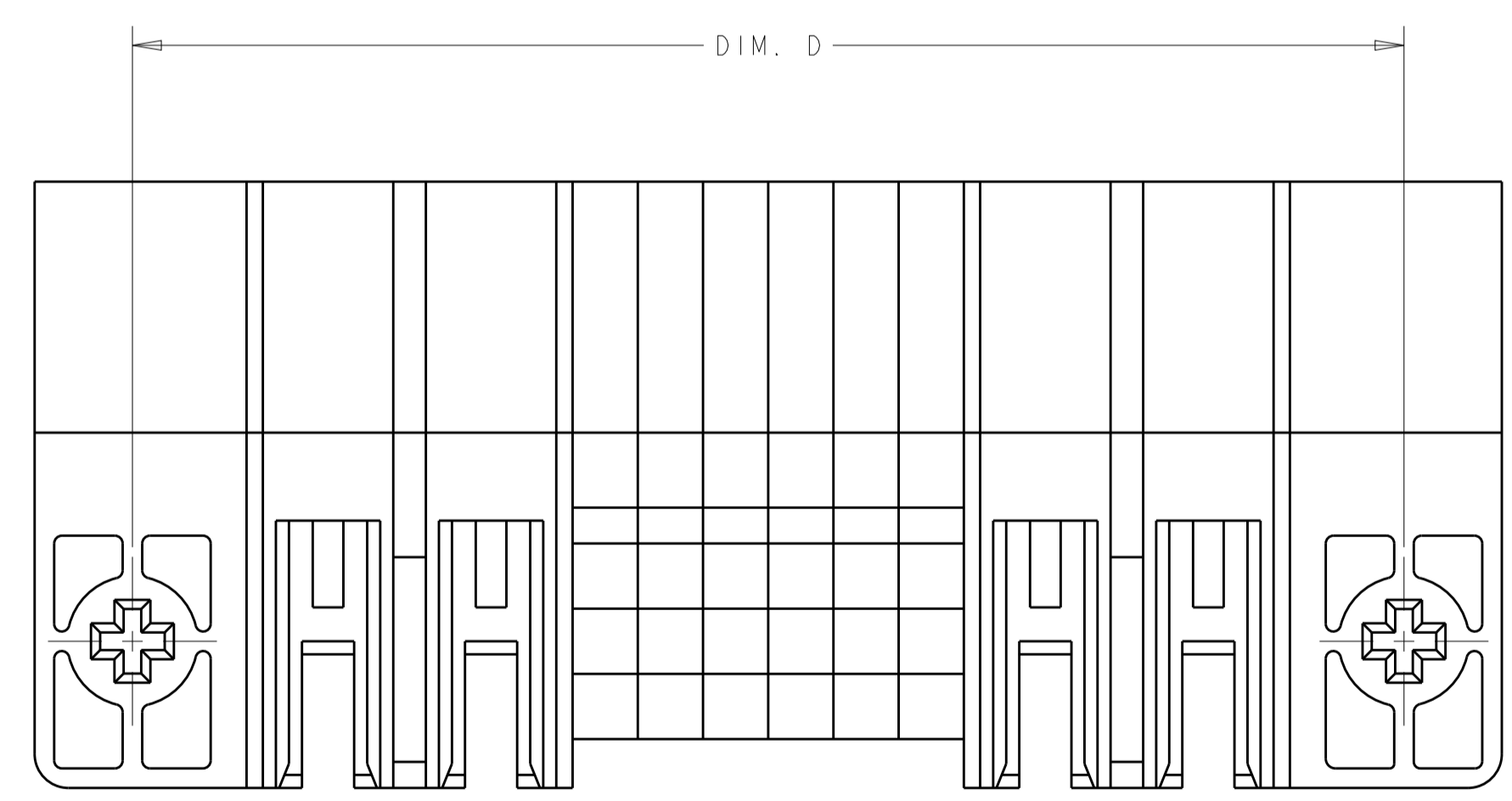
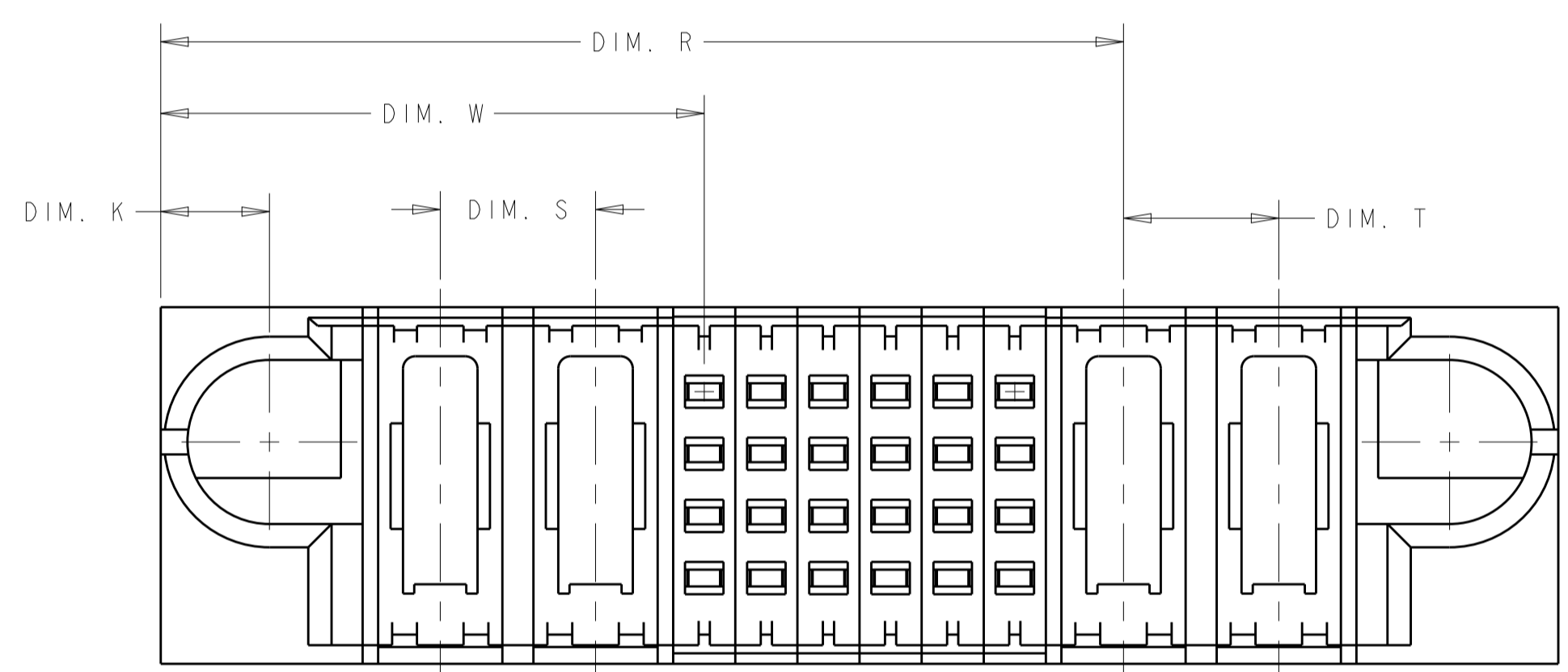
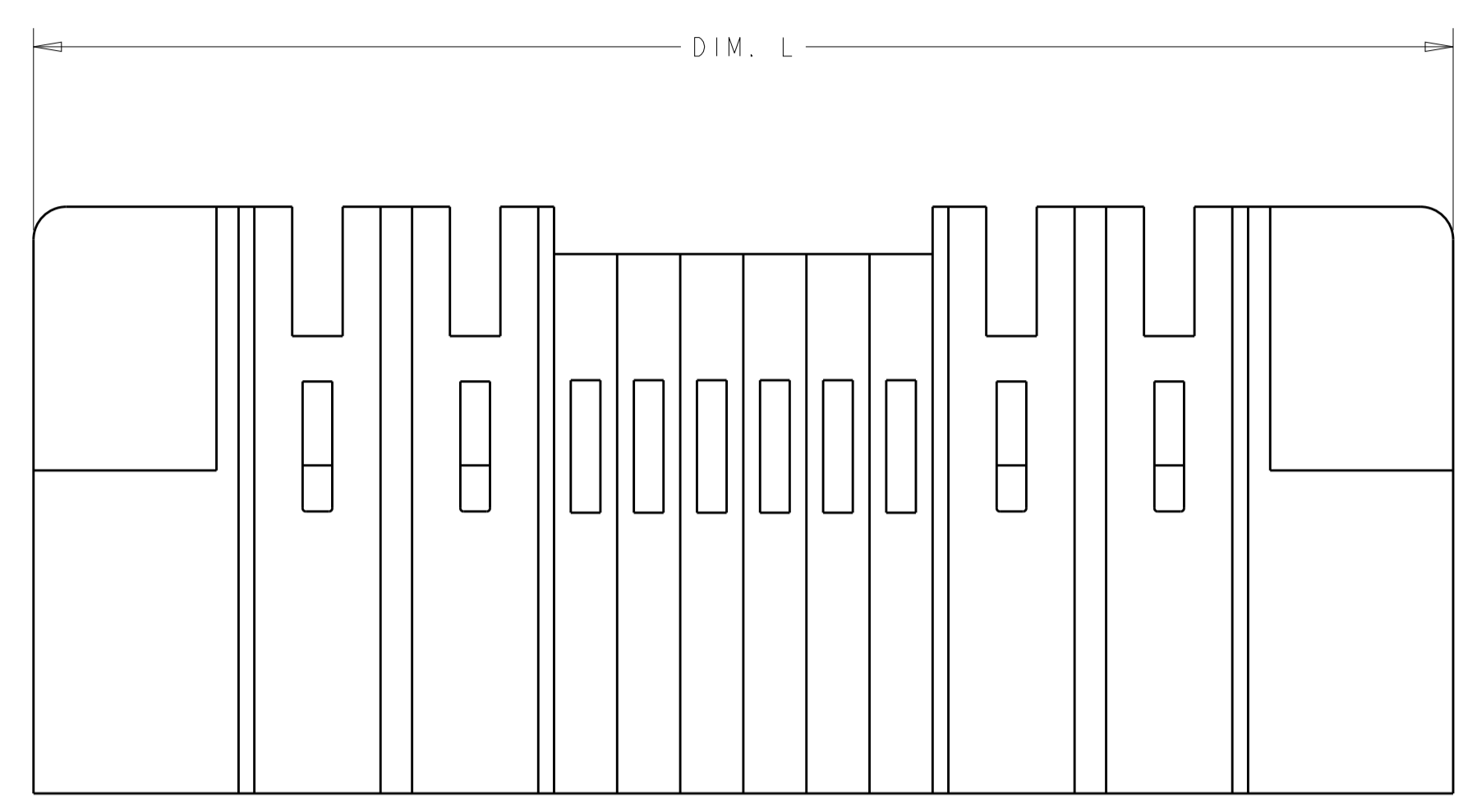

PART 2-6450131-1
(NO CONTACT VIEW)

DIM R	DIM T	DIM U	DIM S	DIM K	DIM D	DIM W	DIM L	DESCRIPTION	PART NUMBER
-	-	1.700	.250	.375	1.750	.850	2.050	16S + 4P	2-6450131-2
1.550	.250	1.900	.250	.450	1.950	.875	2.250	24S	2-6450131-1
		1.600	.250	.375	1.650	.750	1.950	12S + 4P	1-6450131-9
		3.650	.250	.400	3.700	1.300	4.000	32S + 10P	1-6450131-8
		2.950	.200	.375	3.000	1.050	3.300	24S + 10HDP	1-6450131-7
		2.400	.250	.375	2.450	1.050	2.750	24S + 6P	1-6450131-6
		2.450	.200	.375	2.500	.950	2.800	20S + 8P	1-6450131-5
		2.400	.250	.375	2.450	1.050	2.750	24S + 6P	1-6450131-4
		2.550	.200	.375	2.600	1.050	2.900	24S + 3P + 16S + 3P	1-6450131-3
		2.500	.250	.425	2.550	.875	2.850	12S + 7P	1-6450131-1
		2.400	.250	.375	2.450	1.050	2.750	24S + 6P	6450131-7
		2.700	.300	.375	2.750	.775	3.050	12S + 7ACP	6450131-6
		2.400	.250	.375	2.450	1.050	2.750	24S + 6P	6450131-5
		4.400	.250	.375	4.450	1.050	4.750	24S + 14P	6450131-4
		1.950	.250	.375	2.000	.850	2.300	16S + 5P	6450131-3

THIS DRAWING IS A CONTROLLED DOCUMENT.

DIMENSIONS: INCHES	TOLERANCES UNLESS OTHERWISE SPECIFIED: 0 PLC ±. 1 PLC ±.01 2 PLC ±.01 3 PLC ±.005 4 PLC ±.0020 ANGLES ±.0°	DMN R. GRZYBOWSKI CHK M. PERCHERKE APVD M. PERCHERKE	15FEB05 15FEB05	NAME M. PERCHERKE	PRODUCT SPEC 108-1973	APPLICATION SPEC 114-13038	SIZE A1	CAGE CODE 100779	DRAWING NO 6450131	RESTRICTED TO -
MATERIAL	FINISH	WEIGHT	CUSTOMER DRAWING	SCALE 2:1	SHEET 2	OF 8	REV E8			

TE Connectivity
 RIGHT ANGLE HEADER ASSY
 SOLDER CONTACTS, W/GUIDES
 MULTI-BEAM XL

PART NUMBER	ROWS	SIGNAL				POWER					
		1	2	3	4	P1	P2	P3	P4	P5	
6450131-3	D	J	J	J	J	PM	PM	PM	PM	PM	
	C	K	K	K	K						
	B	N	N	N	N						
	A	S	S	S	H						
16S + 5P		HD									

PART NUMBER	ROWS	SIGNAL						POWER															
		1	2	3	4	5	6	P1	P2	P3	P4	P5	P6	P7	P8	P9	P10	P11	P12	P13	P14		
6450131-4	D	J	J	J	J	J	J	PM	PM	PM	PM	PM	PM	PM	PM	PM	PM	PM	PM	PM	PM	PM	PM
	C	K	K	K	K	K	K																
	B	N	N	N	N	N	N																
	A	S	S	H	H	S	S																
24S + 14P		HD																					

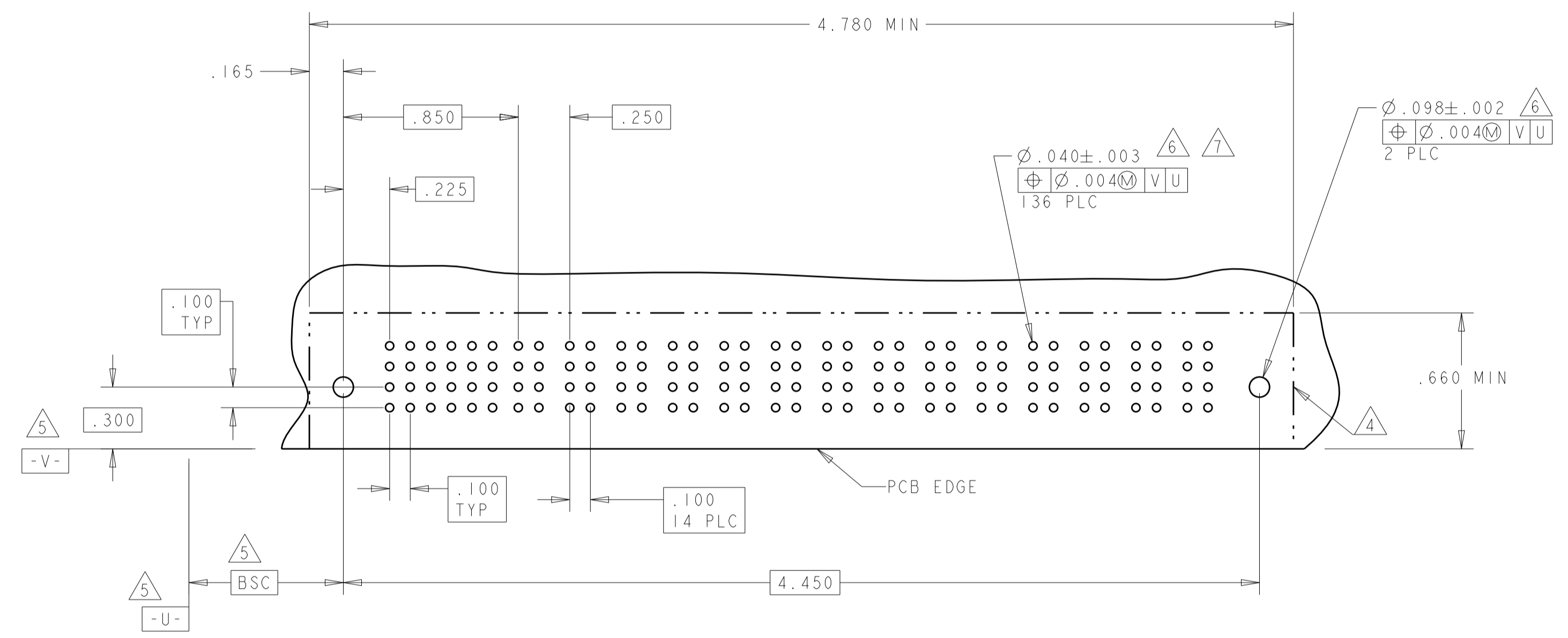
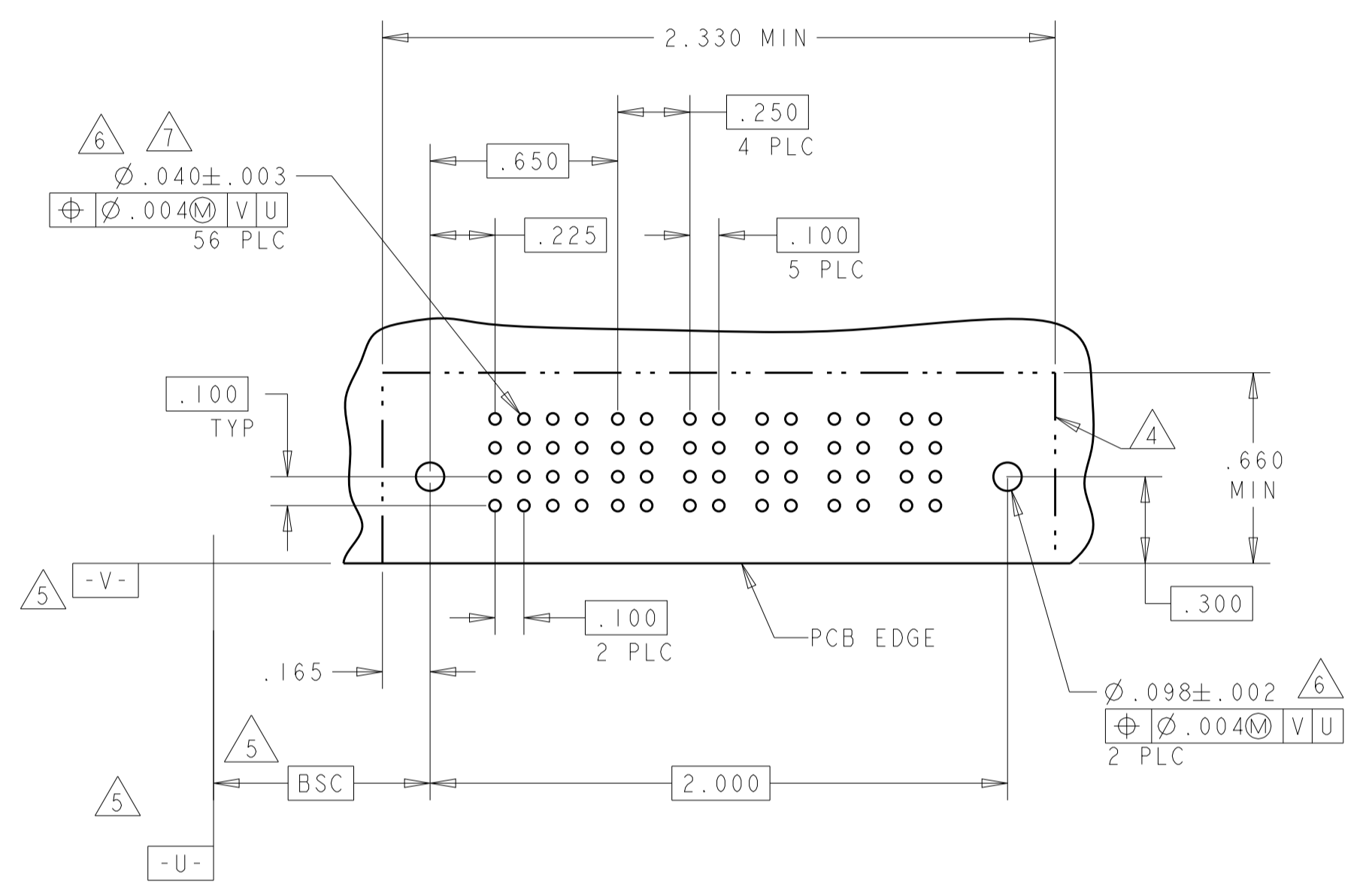

PART NUMBER	ROWS	SIGNAL						POWER					
		1	2	3	4	5	6	P1	P2	P3	P4	P5	P6
6450131-5	D	J	J	J	J	J	E	PM	PM	PM	PM	PM	PM
	C	K	K	K	K	K	K						
	B	N	N	N	N	N	N						
	A	H	S	S	S	S	S						
24S + 6P		HD											

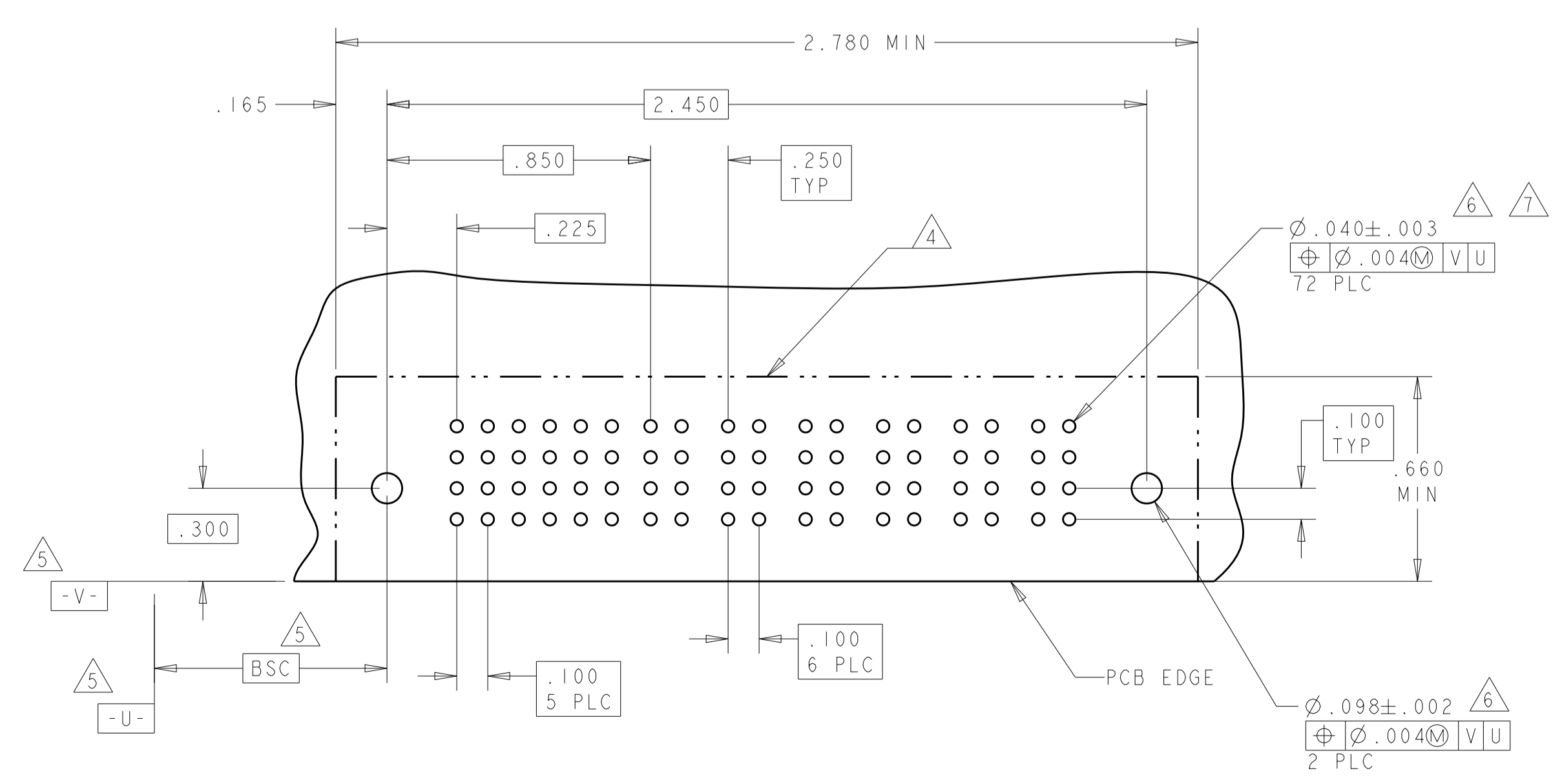

Z	STD	.090	D
Y	STD	.090	C
R	STD	.090	B
O	STD	.090	A
A4	MLBF	.090	D
A3	MLBF	.090	C
A2	MLBF	.090	B
A1	MLBF	.090	A
E	MLBF	.135	D
F	MLBF	.135	C
G	MLBF	.135	B
H	MLBF	.135	A
FJ	MFLB	.135	D
J	STD	.135	D
K	STD	.135	C
N	STD	.135	B
S	STD	.135	A
CODE	MATING SEQUENCE	TAIL LENGTH	ROW
SIGNAL CONTACT			

PA	.090
PM	.135
CODE	TAIL LENGTH
POWER CONTACT	

THIS DRAWING IS A CONTROLLED DOCUMENT.		DWN: R. GRZYBOWSKI	15FEB05
DIMENSIONS: INCHES		CHK: M. PERCHERKE	15FEB05
TOLERANCES UNLESS OTHERWISE SPECIFIED:		APVD: M. PERCHERKE	NAME
0 PLC	±	PRODUCT SPEC	
1 PLC	±.01	108-1973	
2 PLC	±.01	APPLICATION SPEC	
3 PLC	±.005	114-13038	
4 PLC	±.002	WEIGHT	
ANGLES	±.020	CAGE CODE DRAWING NO	
FINISH		114-13038	
MATERIAL		RESTRICTED TO	
		A100779	
CUSTOMER DRAWING		SCALE 2:1 SHEET 3 OF 8 REV E8	

PART NUMBER	ROWS	SIGNAL			POWER						
		1	2	3	P1	P2	P3	P4	P5	P6	P7
6450131-6	D C B A	Z	Z	Z	PA	PA	PA	PA	PA	PA	PA
		Y	Y	Y							
		R	R	R							
		A	O	O							

NO POWER CONTACT LOADED IN THIS CAVITY

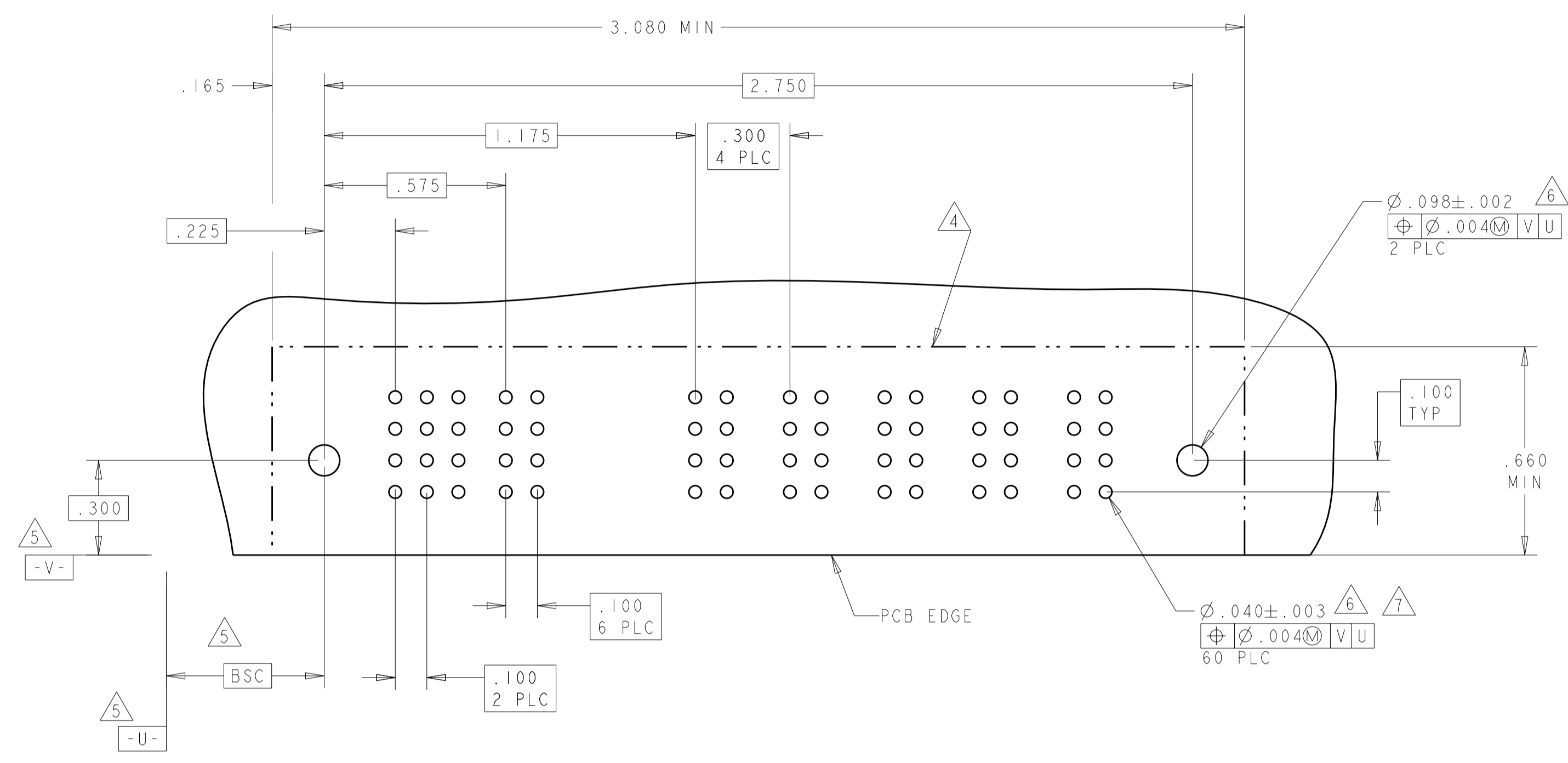

PART NUMBER	ROWS	SIGNAL						POWER					
		1	2	3	4	5	6	P1	P2	P3	P4	P5	P6
6450131-7	D C B A	E	E	J	J	J	E	PM	PM	PM	PM	PM	PM
		F	F	K	K	K	K						
		G	G	N	N	N	N						
		H	H	S	S	S	S						

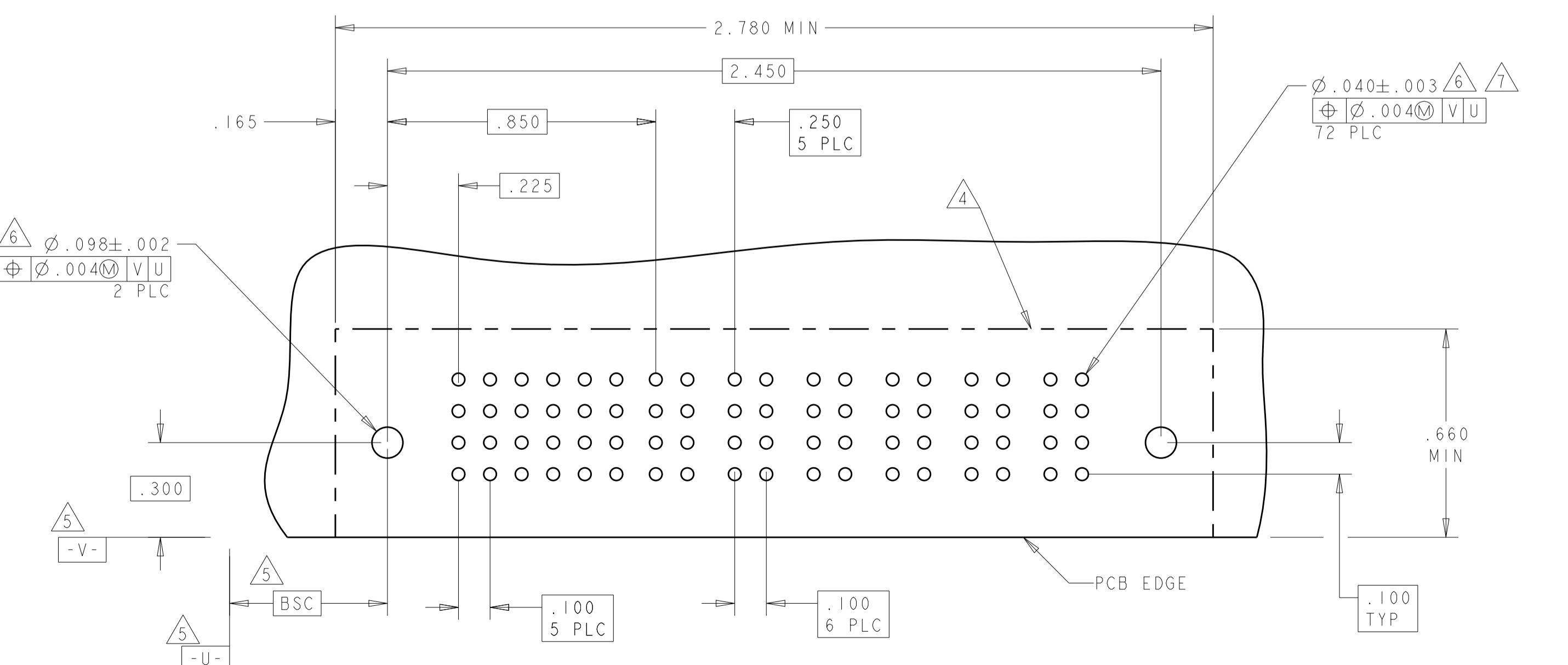

PART NUMBER	ROWS	SIGNAL			POWER						
		1	2	3	P1	P2	P3	P4	P5	P6	P7
1-6450131-1	D C B A	J	J	J	PM	PM	PM	PM	PM	PM	PM
		K	K	K							
		N	N	N							
		S	S	S							

NO CONTACTS LOADED

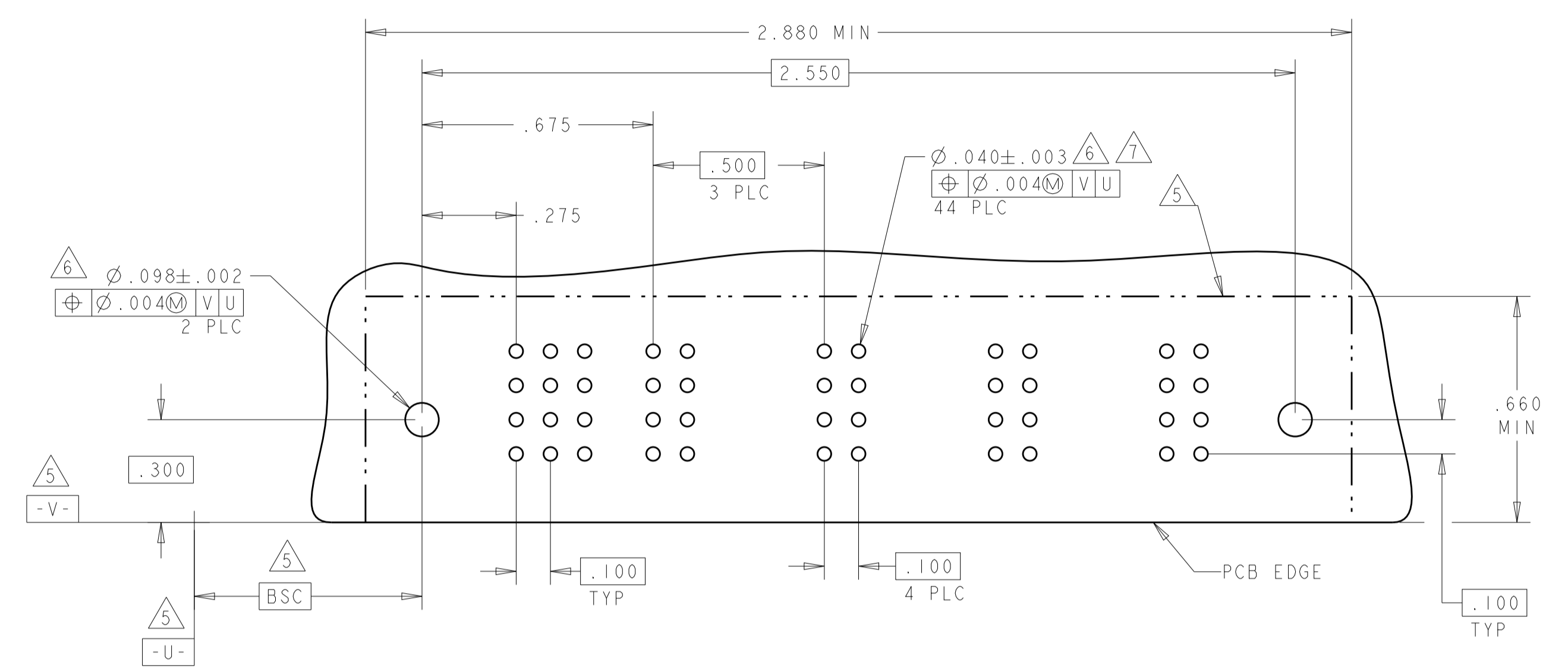

PART NUMBER	ROWS	SIGNAL						POWER			SIGNAL			POWER			
		1	2	3	4	5	6	P1	P2	P3	7	8	9	10	P4	P5	P6
1-6450131-3	D C B A	J	J	J	J	J	E	PM	PM	PM					PM	PM	PM
		K	K	K	K	K	K										
		N	N	N	N	N	N										
		H	S	S	S	S	S										

NO CONTACTS LOADED

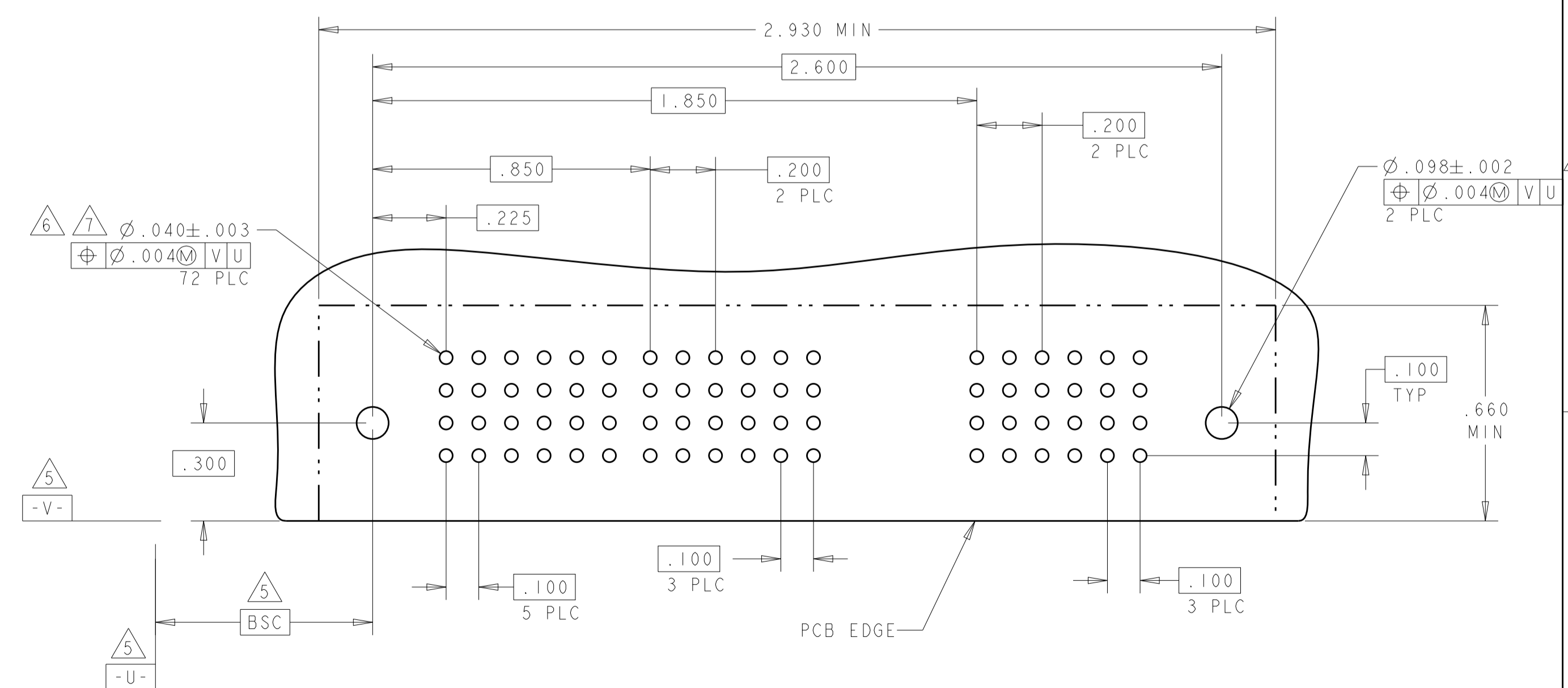

THIS DRAWING IS A CONTROLLED DOCUMENT.

DIMENSIONS: INCHES	TOLERANCES UNLESS OTHERWISE SPECIFIED: 0 PLC ±. 1 PLC ±.01 3 PLC ±.005 4 PLC ±.0020 ANGLES ±.0020	DWN R. GRZYBOWSKI CHK M. PERCHERKE APVD M. PERCHERKE	15FEB05 15FEB05		TE Connectivity
MATERIAL	FINISH	NAME RIGHT ANGLE HEADER ASSY SOLDER CONTACTS, W/GUIDES MULTI-BEAM XL	PRODUCT SPEC 108-1973 APPLICATION SPEC 114-13038		SIZE A100779

CUSTOMER DRAWING SCALE 2:1 SHEET 4 OF 8 REV E8

LOC		DIST		REVISIONS			
ES	00	P	LTN	DESCRIPTION	DATE	OWN	APVD
				SEE SHEET 1			

PART NUMBER	ROWS	SIGNAL						POWER							
		1	2	3	4	5	6	P1	P2	P3	P4	P5	P6		
1-6450131-4	D	J	J	J	J	J	J	PM	PM	PM	PM	PM	PM		
	C	K	K	K	K	K	K								
	B	N	N	N	G	N	N								
	A	S	S	S	H	S	S								
24S + 6P		HD												HD	

PART NUMBER	ROWS	SIGNAL					POWER								
		1	2	3	4	5	P1	P2	P3	P4	P5	P6	P7	P8	
1-6450131-5	D	J	J	J	J	J	PM	PM	PM	PM	PM	PM	PM	PM	
	C	K	K	K	K	K									
	B	N	G	N	N	N									
	A	S	S	S	S	S									
20S + 8P		HD												HD	

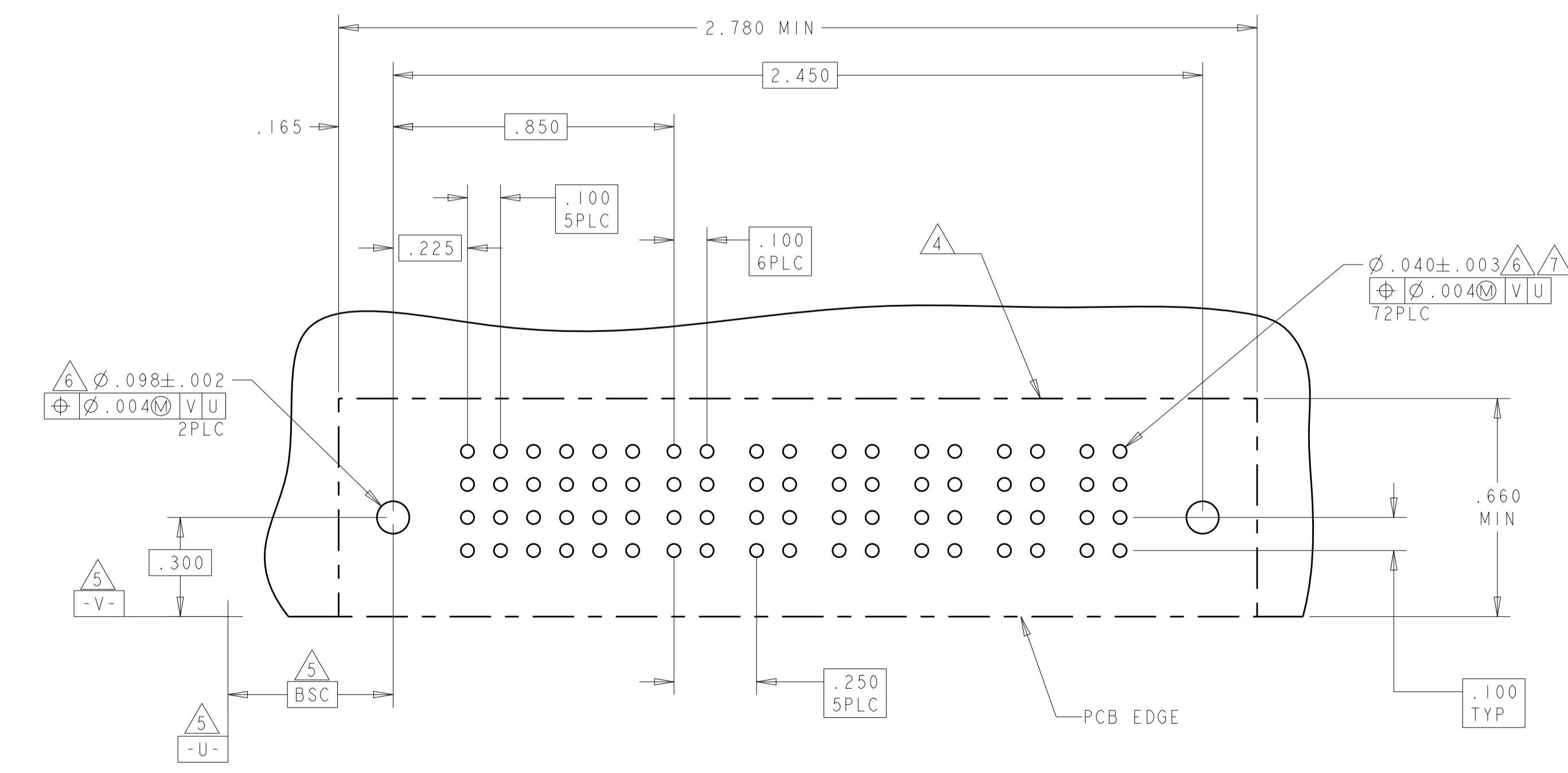
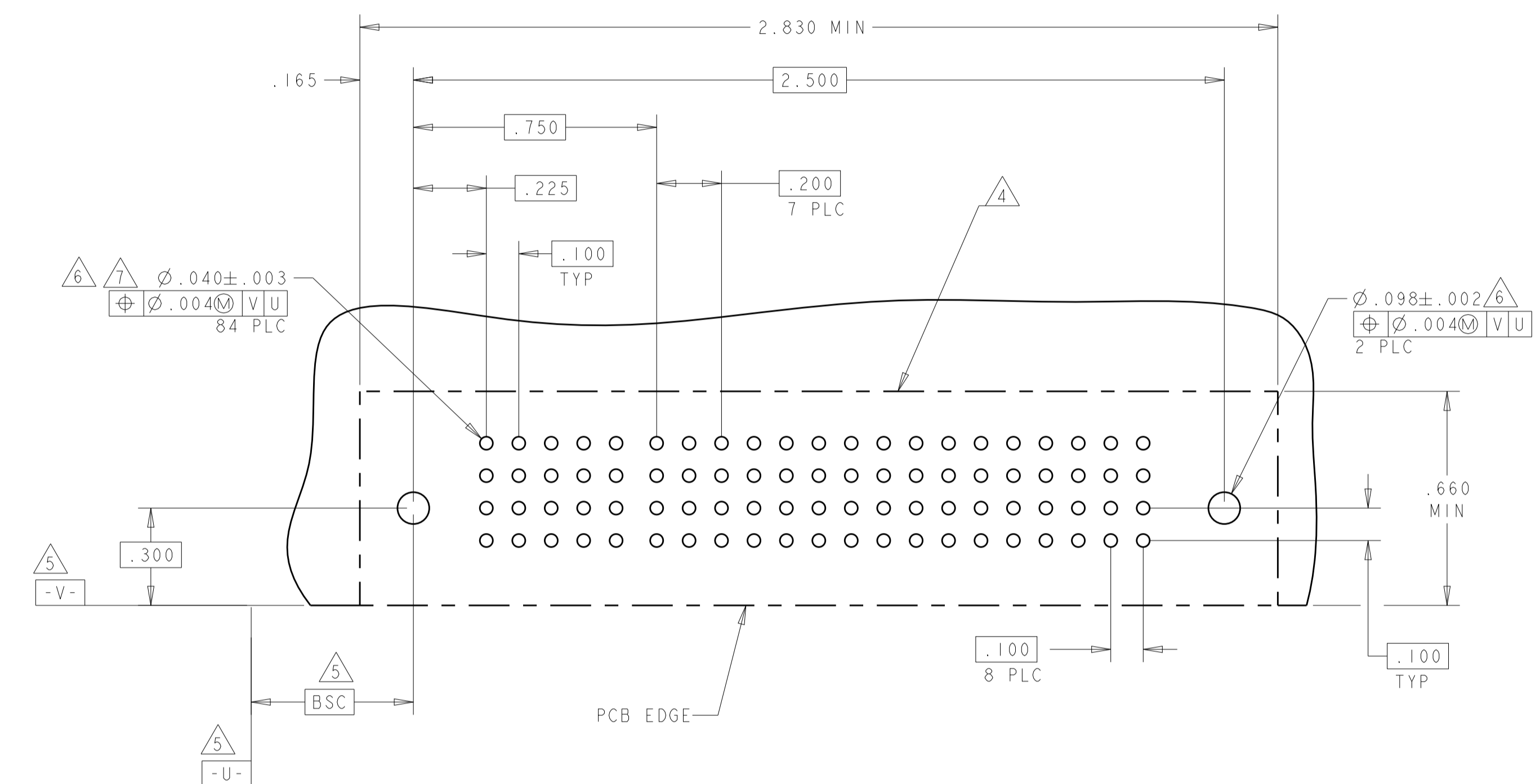
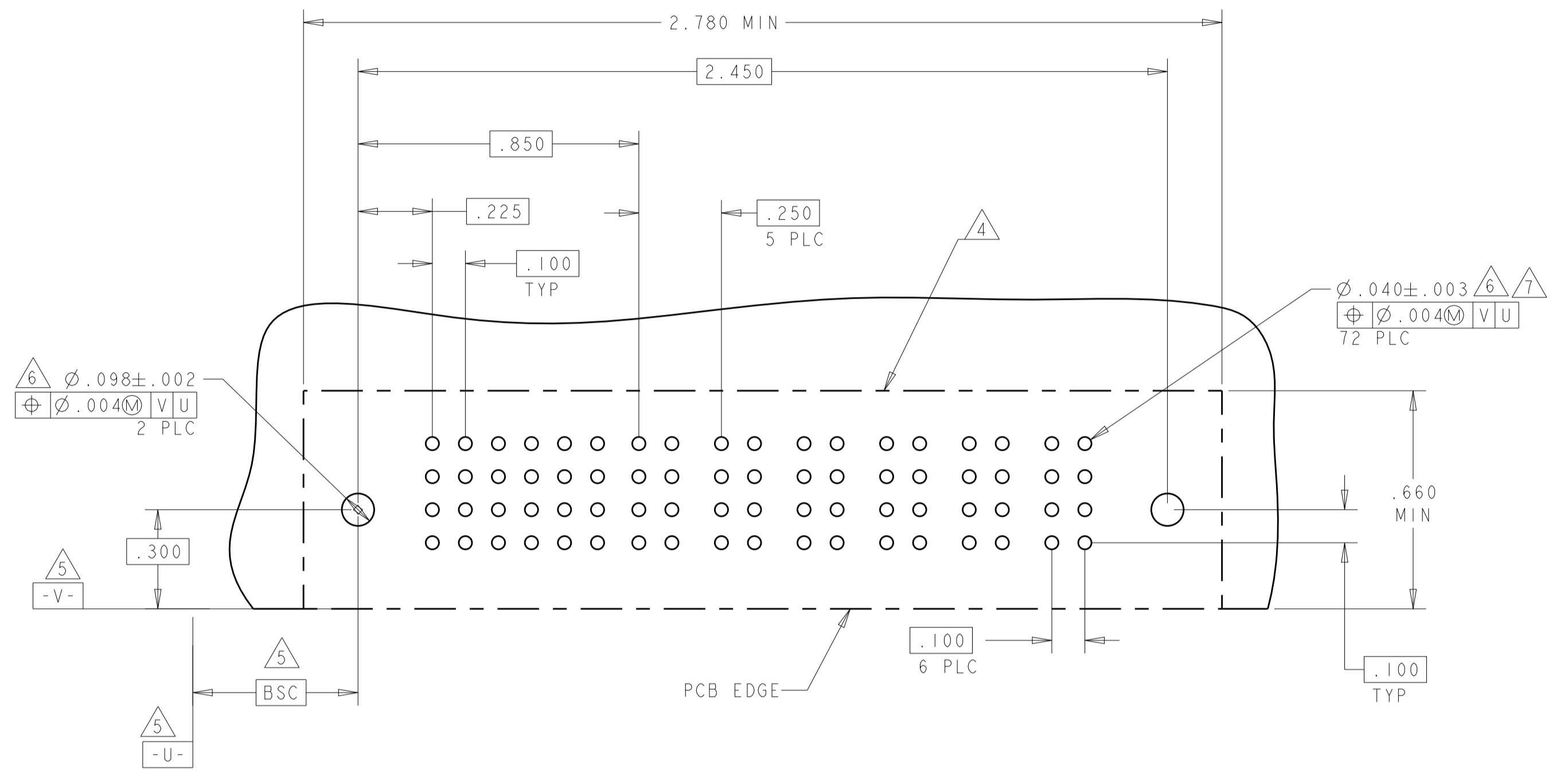

PART NUMBER	ROWS	SIGNAL						POWER							
		1	2	3	4	5	6	P1	P2	P3	P4	P5	P6		
1-6450131-6	D	J	J	J	J	J	E	PM	PM	PM	PM	PM	PM		
	C	K	K	K	K	K	K								
	B	N	N	N	N	N	N								
	A	H	S	S	S	S	S								
24S + 6P		HD												HD	

THIS DRAWING IS A CONTROLLED DOCUMENT. **STE** TE Connectivity

DIMENSIONS: INCHES	TOLERANCES UNLESS OTHERWISE SPECIFIED:	OWN: R. GRZYBOWSKI 15FEB05	CHK: M. PERCHERKE 15FEB05
	0 PLC ±.010 1 PLC ±.008 2 PLC ±.005 3 PLC ±.003 4 PLC ±.002 ANGLES ±.0020	APVD: M. PERCHERKE	NAME: M. PERCHERKE
MATERIAL: -	FINISH: -	PRODUCT SPEC: 108-1973	APPLICATION SPEC: 114-13038
CUSTOMER DRAWING		WEIGHT: -	SCALE: 2:1

RIGHT ANGLE HEADER ASSY
 SOLDER CONTACTS, W/GUIDES
 MULTI-BEAM XL

SIZE: 114-13038
 CAGE CODE: A100779
 DRAWING NO: C=6450131
 SHEET 5 OF 8
 REV: E8

LOC		DIST		REVISIONS			
ES	00	P	LTN	DESCRIPTION	DATE	DMN	APVD
		-		SEE SHEET 1			

PART NUMBER	ROWS	SIGNAL						POWER											
		1	2	3	4	5	6	P1	P2	P3	P4	P5	P6	P7	P8	P9	P10		
1-6450131-7	D	J	J	J	J	J	J	PM	PM	PM	PM	PM	PM	PM	PM	PM	PM	PM	
	C	K	K	K	F	K	K	PM	PM	PM	PM	PM	PM	PM	PM	PM	PM	PM	
	B	N	N	N	N	N	N	PM	PM	PM	PM	PM	PM	PM	PM	PM	PM	PM	
	A	S	S	S	S	S	S												
24S + 10HDP																			

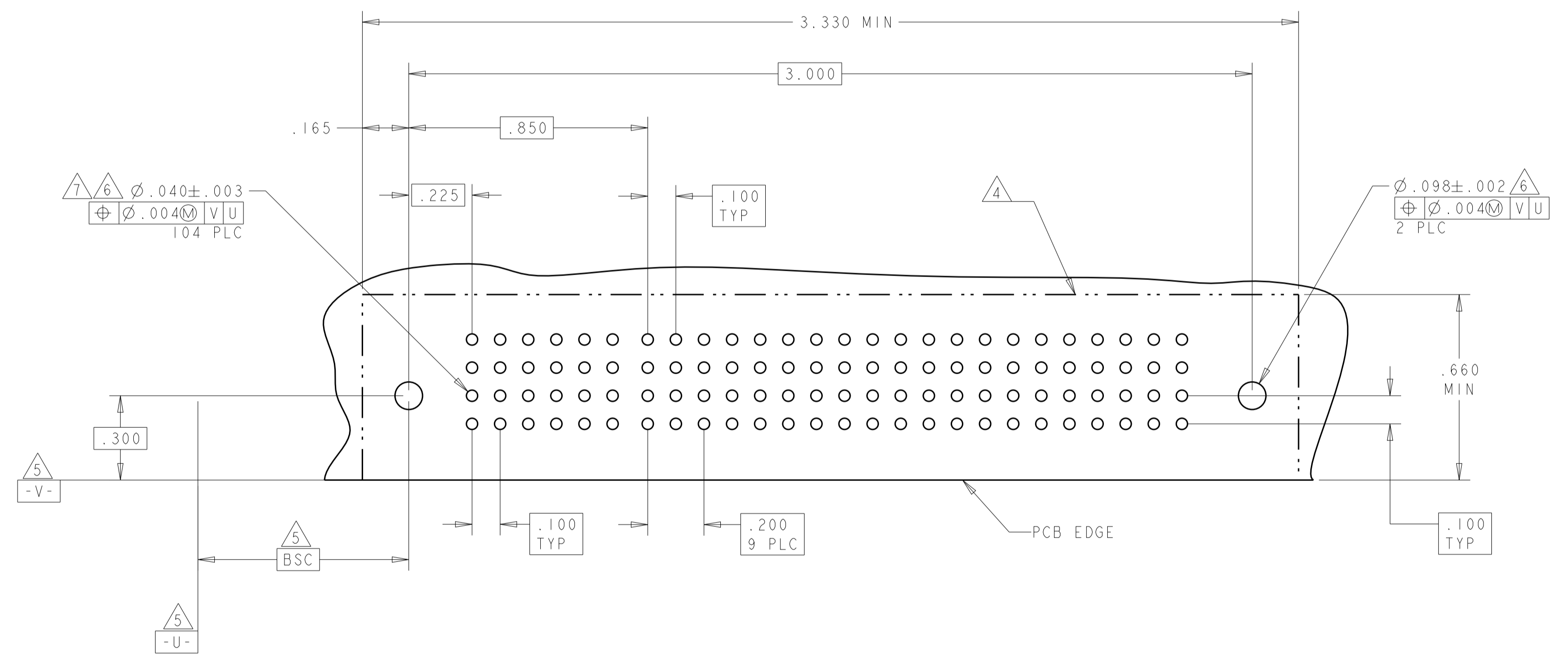

THIS DRAWING IS A CONTROLLED DOCUMENT.		DMN	R. GRZYBOWSKI	15FEB05	TE Connectivity
DIMENSIONS: INCHES		CHK	M. PERCHERKE	15FEB05	
TOLERANCES UNLESS OTHERWISE SPECIFIED:		APVD	M. PERCHERKE		NAME
0 PLC	±	PRODUCT SPEC		RIGHT ANGLE HEADER ASSY	
1 PLC	±.01	APPLICATION SPEC		SOLDER CONTACTS, W/GUIDES	
2 PLC	±.005	RESTRICTED TO		MULTI-BEAM XL	
3 PLC	±.0020	SIZE	CAGE CODE	DRAWING NO	
4 PLC	±.0020	114-13038		A100779	6450131
5 PLC	±.0020	WEIGHT			
ANGLES	±.0020	CUSTOMER DRAWING	SCALE	2:1	SHEET 6 OF 8
FINISH					REV E8

LOC	DIST	REVISIONS			
P	LTN	DESCRIPTION	DATE	DMN	APVD
-	-	SEE SHEET 1	-	-	-

PART NUMBER	ROWS	SIGNAL								POWER									
		1	2	3	4	5	6	7	8	P1	P2	P3	P4	P5	P6	P7	P8	P9	P10
I-6450131-8	D	J	J	J	J	J	J	J	J	PM	PM	PM	PM	PM	PM	PM	PM	PM	PM
	C	K	K	K	F	F	K	K	K										
	B	N	N	N	G	G	N	N	N										
32S + 10P	A	S	S	S	S	S	S	S	S										

PART NUMBER	ROWS	SIGNAL			POWER			
		1	2	3	P1	P2	P3	P4
I-6450131-9	D	J	FJ	FJ				
	C	K	K	K	PM	PM	PM	PM
	B	N	N	N				
12S + 4P	A	H	H	S				

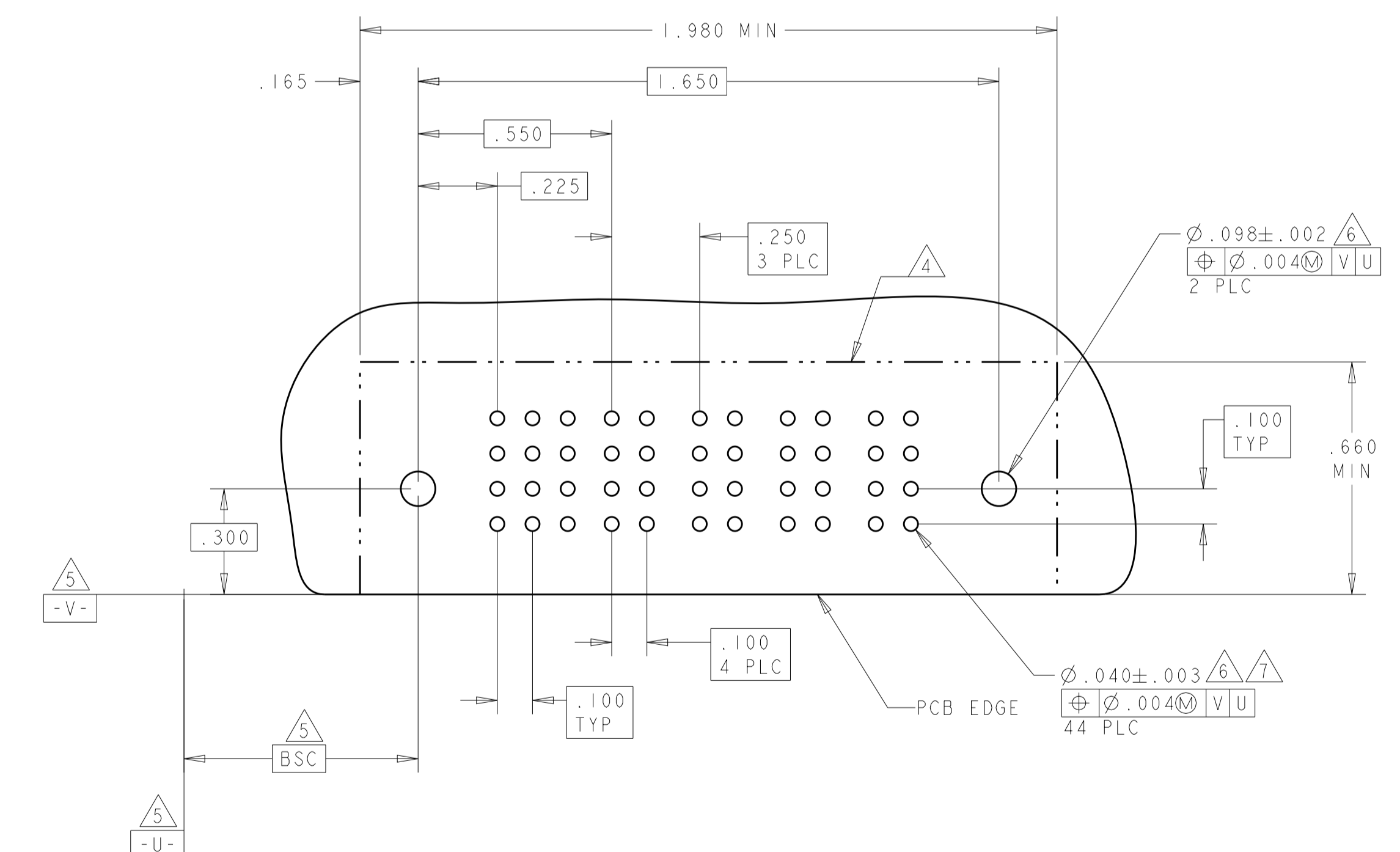
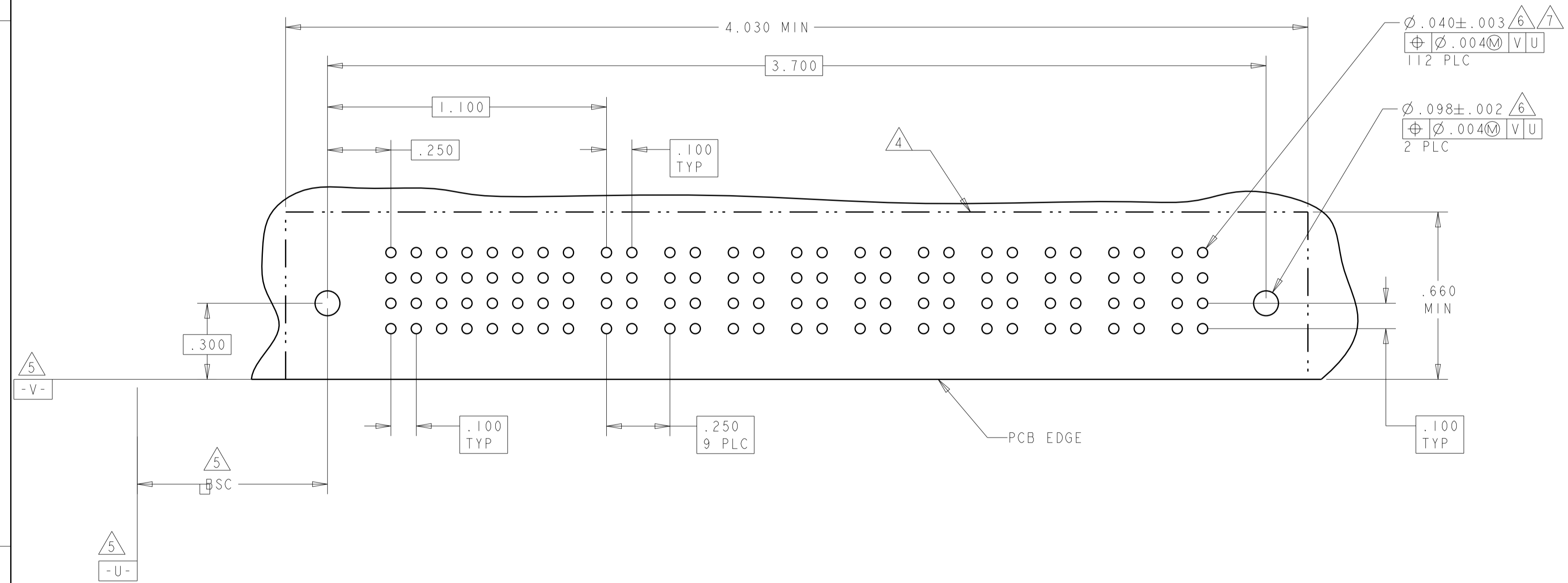

THIS DRAWING IS A CONTROLLED DOCUMENT.

DIMENSIONS:	TOLERANCES UNLESS OTHERWISE SPECIFIED:	OWN: R. GRZYBOWSKI 15FEB05	CHK: M. PERCHERKE 15FEB05	APVD: M. PERCHERKE	NAME: R. GRZYBOWSKI
INCHES	0 PLC ±.01 2 PLC ±.01 3 PLC ±.01 4 PLC ±.005 ANGLES ±.020	PRODUCT SPEC: 108-1973	APPLICATION SPEC: 114-13038	WEIGHT: -	RESTRICTED TO: -
MATERIAL: -	FINISH: -	CAGE CODE: 114-13038	DRAWING NO: 114-13038	SCALE: 2:1	SHEET 7 OF 8
CUSTOMER DRAWING		A100779C=6450131		REV: E8	

TE Connectivity

RIGHT ANGLE HEADER ASSY
 SOLDER CONTACTS, W/GUIDES
 MULTI-BEAM XL

LOC	DIST	REVISIONS			
P	LTN	DESCRIPTION	DATE	DMN	APVD
ES	00	SEE SHEET 1			

PART NUMBER	ROWS	POWER		SIGNAL						POWER	
		P1	P2	1	2	3	4	5	6	P3	P4
2-6450131-1	D	HD	HD	J	J	J	J	J	J	HD	HD
	C			K	K	K	K	K	F		
	B			N	N	N	N	N	N		
	A			S	S	S	S	S	S		

24S

NO CONTACT LOADED

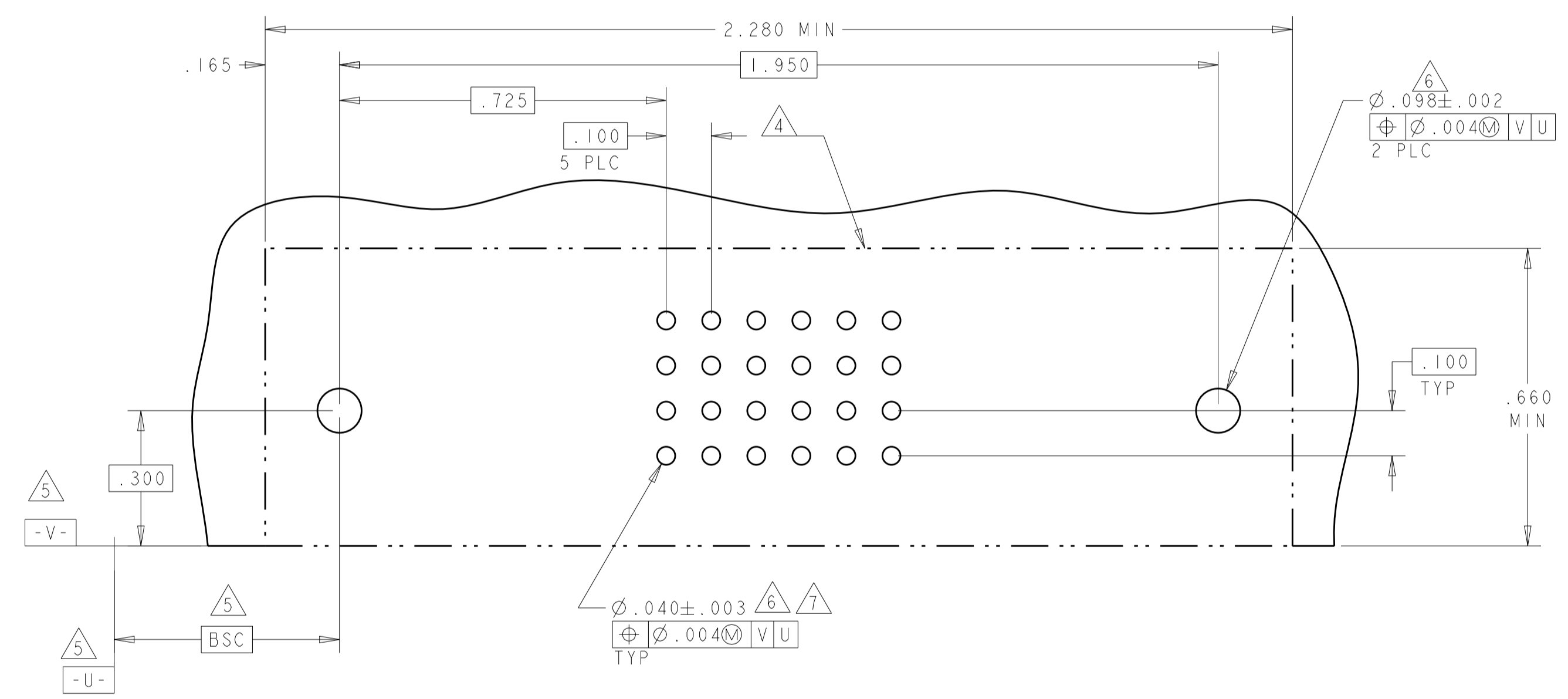

PART NUMBER	ROWS	SIGNAL				POWER			
		1	2	3	4	P1	P2	P3	P4
2-6450131-2	D	J	J	J	J	HD	HD		
	C	K	K	K	K				
	B	N	N	N	N				
	A	H	S	S	S				

16S + 4P

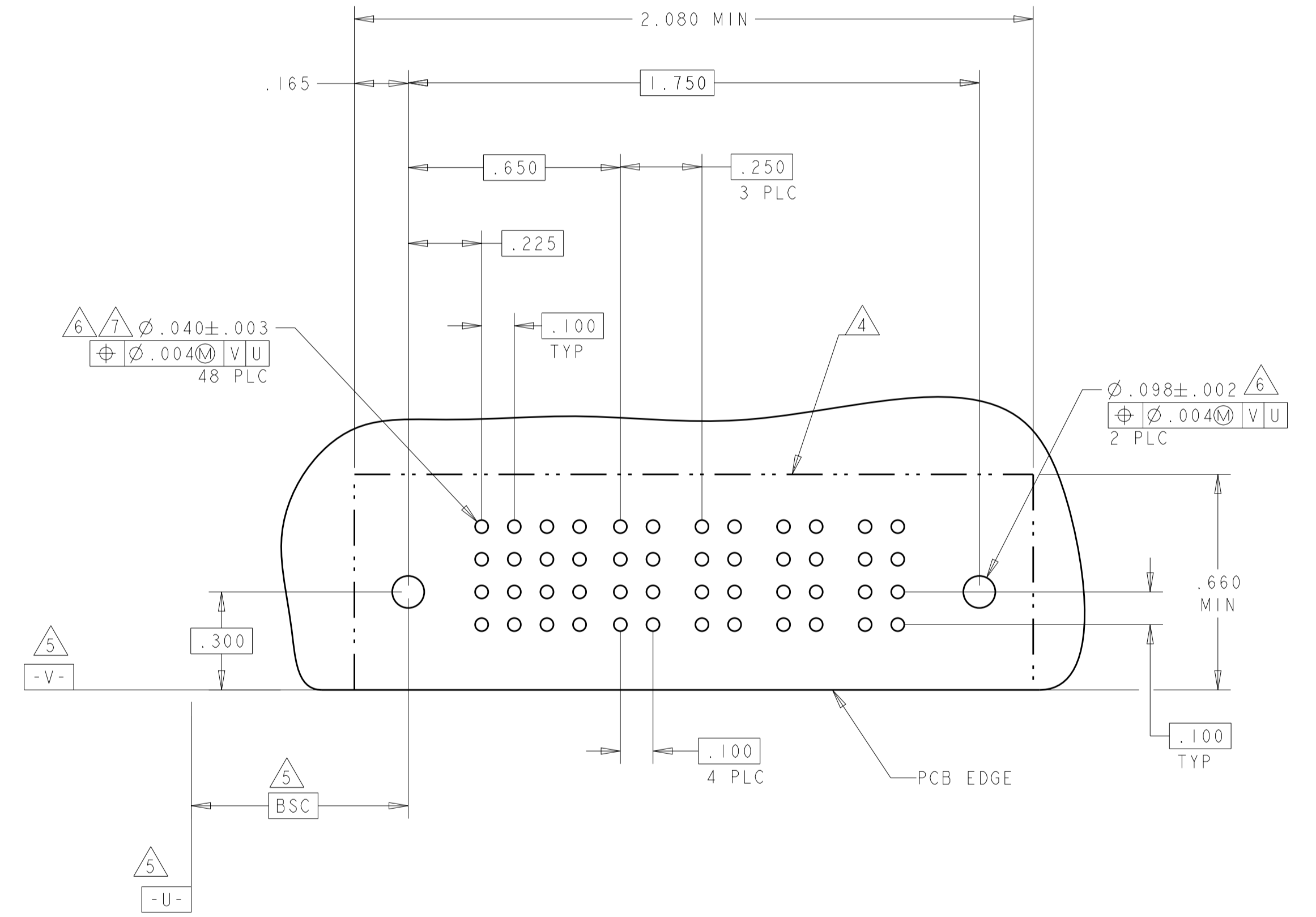

THIS DRAWING IS A CONTROLLED DOCUMENT.		DMN: R. GRZYBOWSKI 15FEB05	 TE Connectivity
DIMENSIONS: INCHES		CHK: M. PERCHERKE 15FEB05	
TOLERANCES UNLESS OTHERWISE SPECIFIED:		APVD: M. PERCHERKE	NAME: RIGHT ANGLE HEADER ASSY
0 PLC ± .01		PRODUCT SPEC: 108-1973	SOLDER CONTACTS, W/GUIDES
1 PLC ± .01		APPLICATION SPEC: 114-13038	MULTI-BEAM XL
2 PLC ± .01		SIZE: 114-13038	RESTRICTED TO:
3 PLC ± .01		WEIGHT: -	A100779C=6450131
4 PLC ± .002		CUSTOMER DRAWING	SCALE: 2:1 SHEET 8 OF 8 REV: E8
ANGLES: ± 30°			
FINISH: -			