

## TOOLSTICK C8051F336 DAUGHTER CARD USER'S GUIDE

### 1. Handling Recommendations

To enable development, the ToolStick Base Adapter and daughter cards are distributed without any protective plastics. To prevent damage to the devices and/or the host PC, please take into consideration the following recommendations when using the ToolStick:

- Never connect or disconnect a daughter card to or from the ToolStick Base Adapter while the Base Adapter is connected to a PC.
- Always connect and disconnect the ToolStick Base Adapter from the PC by holding the edges of the boards.

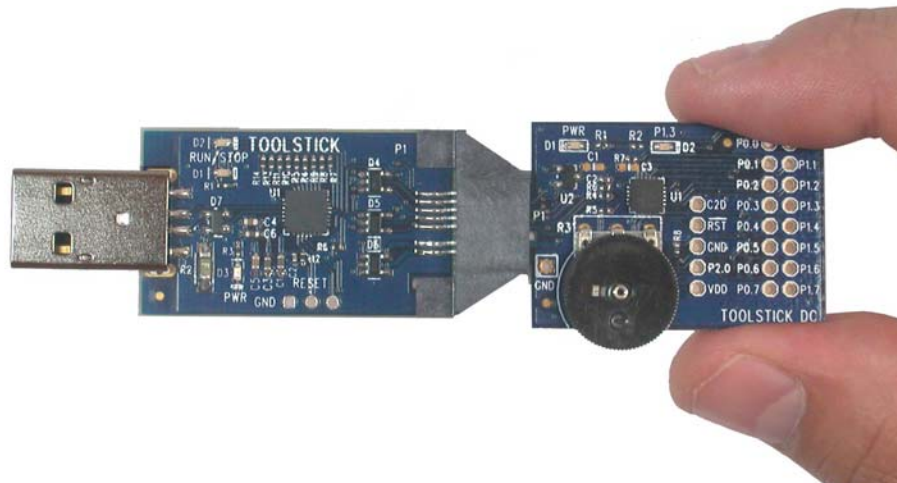

**Figure 1. Proper Method of Holding the ToolStick**

- Avoid directly touching any of the other components.

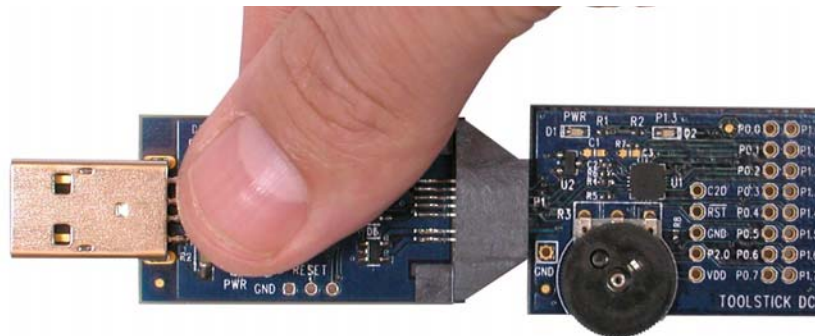

**Figure 2. Improper Method of Holding the ToolStick**

- Manipulate mechanical devices on the daughter cards, such as potentiometers, with care to prevent the Base Adapter or daughter card from accidentally dislodging from their sockets.

# ToolStickF336DC

## 2. Contents

The C8051F336 ToolStick DC (**TOOLSTICK336DC**) kit contains the following items:

- ToolStick C8051F336 Daughter Card

A ToolStick daughter card requires a ToolStick Base Adapter to communicate with the PC. ToolStick Base Adapters can be purchased separately at [www.silabs.com/toolstick](http://www.silabs.com/toolstick).

## 3. ToolStick Overview

The purpose of the ToolStick is to provide a development and demonstration platform for Silicon Laboratories microcontrollers and to demonstrate the Silicon Laboratories software tools, including the Integrated Development Environment (IDE).

The ToolStick development platform consists of two components: the ToolStick Base Adapter and a daughter card. The ToolStick Base Adapter provides a USB debug interface and data communications path between a Windows PC and a target microcontroller.

The target microcontroller and application circuitry are located on the daughter card. Some daughter cards, such as the C8051F336 Daughter Card, are used as general-purpose development platforms for the target microcontrollers and some are used to demonstrate a specific feature or application.

The C8051F336 Daughter Card includes a pair of LEDs, a potentiometer, a resistor across the C8051F336's current DAC output pin, and a small prototyping area which provides access to all of the pins of the device. This prototyping area can be used to connect additional hardware to the microcontroller and use the daughter card as a development platform.

Figure 3 shows the ToolStick C8051F336 Daughter Card and identifies the various components.

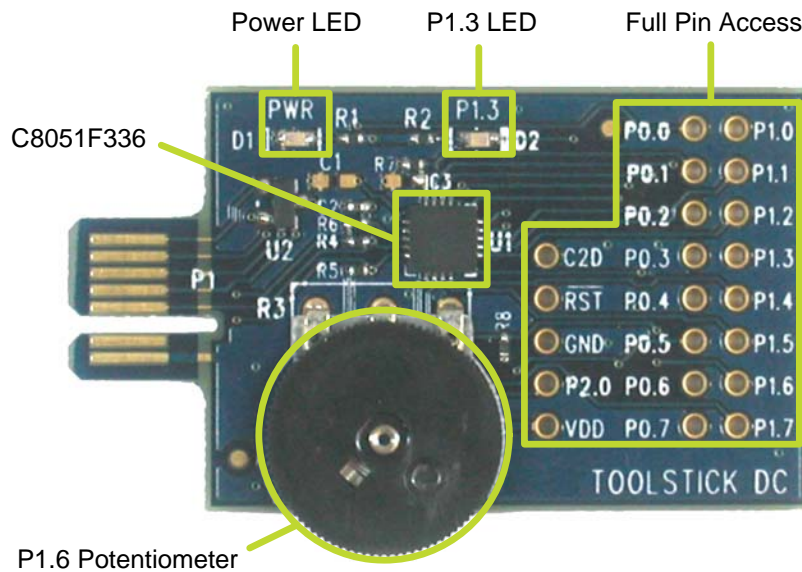

**Figure 3. ToolStick C8051F336 Daughter Card**

## 4. Getting Started

The necessary software to download, debug and communicate with the target microcontroller must be downloaded from [www.silabs.com/toolstick](http://www.silabs.com/toolstick). The following software is necessary to build a project, download code to, and communicate with the target microcontroller:

- **Simplicity Studio**
- **Keil C51 Tools**
- **ToolStick Development Tools**

The software described above is provided in the Simplicity Studio and 8-bit microcontroller studio download packages. The **ToolStick Development Tools** selection includes example code specifically for the ToolStick daughter card, documentation including user's guides and data sheets, and the ToolStick Terminal application. After downloading and installing these packages, see the following sections for information regarding the software and running one of the demo applications.

## 5. Software Overview

Simplicity Studio greatly reduces development time and complexity with Silicon Labs EFM32 and 8051 MCU products by providing a high-powered IDE, tools for hardware configuration, and links to helpful resources, all in one place.

Once Simplicity Studio is installed, the application itself can be used to install additional software and documentation components to aid in the development and evaluation process.

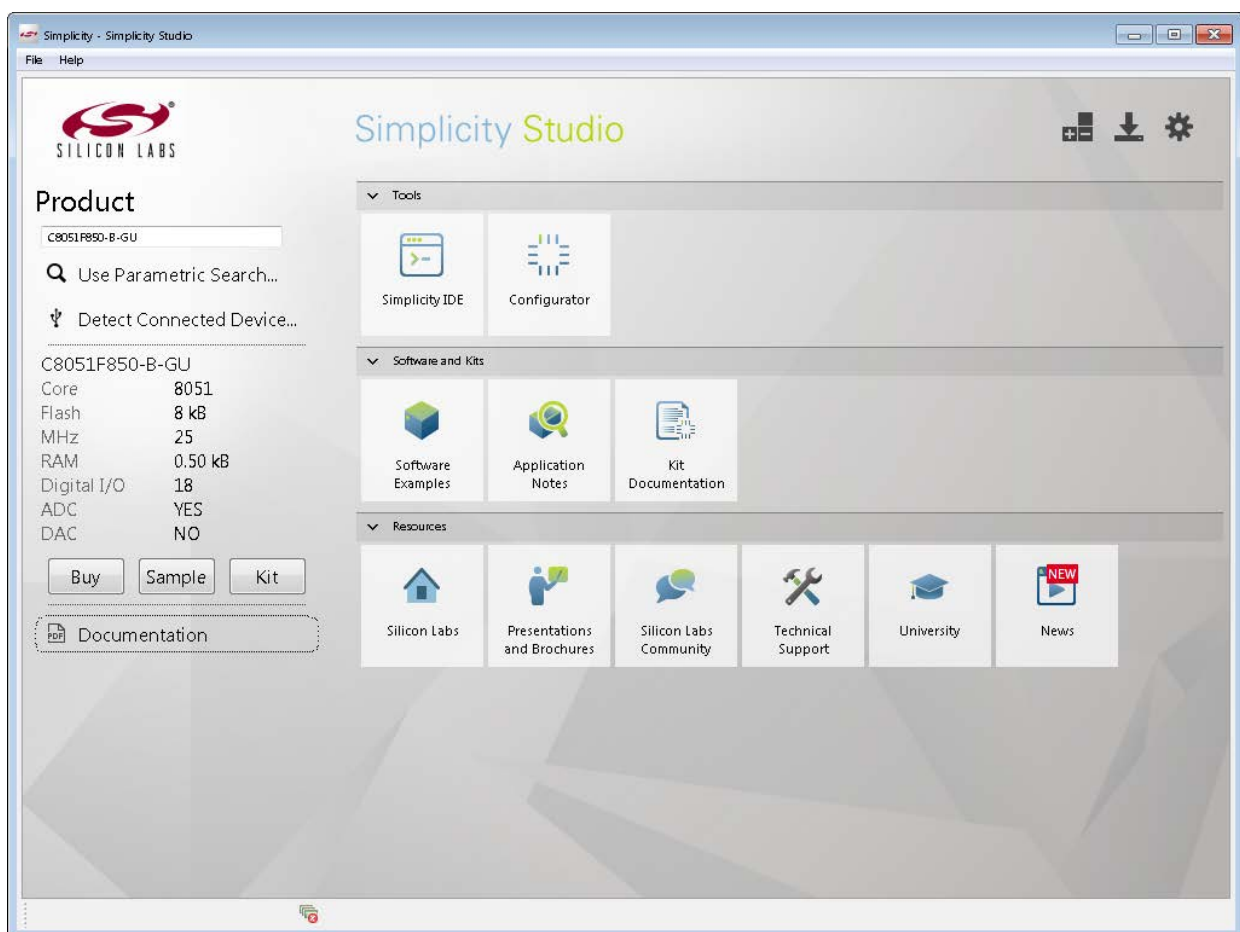

Figure 4. Simplicity Studio

# ToolStickF336DC

---

The following Simplicity Studio components are required for the C8051F336 ToolStick Starter Kit:

- 8051 Products Part Support
- Simplicity Developer Platform

Download and install Simplicity Studio from [www.silabs.com/simplicity-studio](http://www.silabs.com/simplicity-studio). Once installed, run Simplicity Studio by selecting **Start**→**Silicon Labs**→**Simplicity Studio**→**Simplicity Studio** from the start menu or clicking the **Simplicity Studio** shortcut on the desktop. Follow the instructions to install the software and click **Simplicity IDE** to launch the IDE.

The first time the project creation wizard runs, the **Setup Environment** wizard will guide the user through the process of configuring the build tools and SDK selection.

In the **Part Selection** step of the wizard, select from the list of installed parts only the parts to use during development. Choosing parts and families in this step affects the displayed or filtered parts in the later device selection menus. Choose the C8051F33x family by checking the **C8051F33x** check box. Modify the part selection at any time by accessing the **Part Management** dialog from the **Window**→**Preferences**→**Simplicity Studio**→**Part Management** menu item.

Simplicity Studio can detect if certain toolchains are not activated. If the **Licensing Helper** is displayed after completing the **Setup Environment** wizard, follow the instructions to activate the toolchain.

## 5.1. Running the Features Demo

To create a project for the Features Demo example:

1. Click the **Software Examples** tile from the Simplicity Studio home screen.
2. In the **Kit** drop-down, select **C8051F336 ToolStick Daughter Card**, in the **Part** drop-down, select **C8051F336**, and in the **SDK** drop-down, select the desired SDK. Click **Next**.
3. Select **Example** and click **Next**.
4. Under **C8051F336 ToolStick Daughter Card**, select **TS F336-9 FeaturesDemo** and click **Finish**.
5. Click on the project in the **Project Explorer** and click **Build**, the hammer icon in the top bar. Alternatively, go to **Project**→**Build Project**.
6. Click **Debug** to download the project to the hardware and start a debug session.
7. Follow the instructions at the top of the example file to run the demo.
8. Press the **Resume** button to start the code running.



9. Press the **Suspend** button to stop the code.



10. Press the **Reset the device** button to reset the target MCU.



11. Press the **Disconnect** button to return to the development perspective.



5.2. Simplicity Studio Help

Simplicity Studio includes detailed help information and device documentation within the tool. The help contains descriptions for each dialog window. To view the documentation for a dialog, click the question mark icon in the window:



This will open a pane specific to the dialog with additional details. The documentation within the tool can also be viewed by going to **Help**→**Help Contents** or **Help**→**Search**.

5.3. Configuration Wizard 2

The Configuration Wizard 2 is a code generation tool for all of the Silicon Laboratories devices. Code is generated through the use of dialog boxes for each of the device's peripherals.

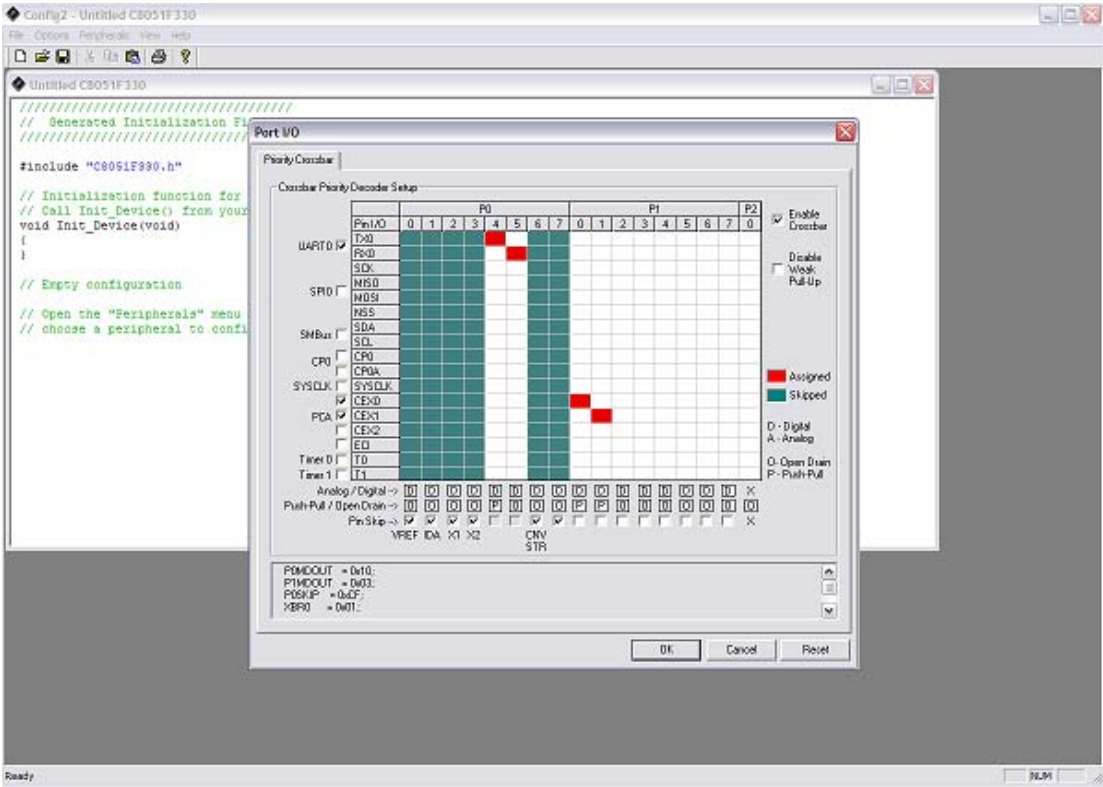

Figure 5. Configuration Wizard 2 Utility

The Configuration Wizard 2 utility helps accelerate development by automatically generating initialization source code to configure and enable the on-chip resources needed by most design projects. In just a few steps, the wizard creates complete startup code for a specific Silicon Laboratories MCU. The program is configurable to provide the output in C or assembly.

Installing the Simplicity Studio software will automatically install Configuration Wizard 2 if it's required for the selected devices. After selecting the desired device in the **Product** area, the Configuration Wizard 2 tile will appear in the **Tools** section.

# ToolStickF336DC

## 5.4. ToolStick Terminal

The ToolStick Terminal program provides the standard terminal interface to the target microcontroller's UART. However, instead of requiring the usual RS-232 and COM port connection, ToolStick Terminal uses the USB interface of the ToolStick Base Adapter to provide the same functionality. The software is available on the ToolStick webpage ([www.silabs.com/toolstick](http://www.silabs.com/toolstick)).

In addition to the standard terminal functions (send file, receive file, change baud rate), two GPIO pins on the target microcontroller can be controlled using the Terminal for either RTS/CTS handshaking or software-configurable purposes.

To use the ToolStick Terminal program:

1. Download an example to the ToolStick device that uses UART communication. One example of this type is the **TS F336-9 FeaturesDemo** example from the Simplicity Studio example project creation wizard.
2. Disconnect from the device in the Simplicity IDE. The IDE and the ToolStick Terminal cannot communicate with the daughter card simultaneously.
3. Open ToolStick Terminal from the **Start** → **Programs** → **Silicon Labs** menu.

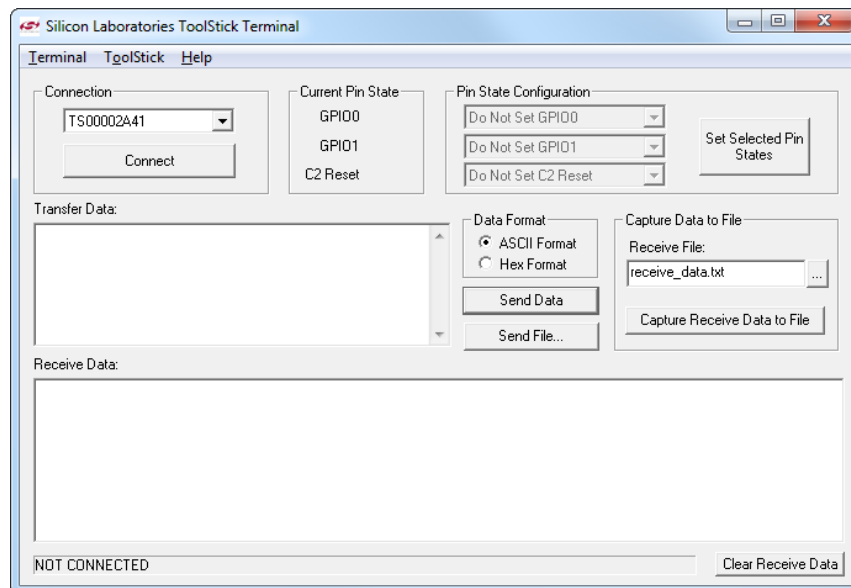

4. In the top, left-hand corner of the Terminal application, available devices are shown in the drop-down Connection menu. Click **Connect** to connect to the device.
5. If using the **TS F336-9 FeaturesDemo** example, text printed from the device will appear in the **Receive Data** window.
6. Rotate the potentiometer on the board to change the blink rate or brightness of the LED.

In addition to the standard two UART pins (TX and RX), there are two GPIO/UART handshaking pins on the ToolStick Base Adapter that are connected to two port pins on the target microcontroller. ToolStick Terminal is used to configure and read/write these pins. Under **Pin State Configuration** area in ToolStick Terminal, select the desired state from the drop-down menu and click the **Set Selected Pin States** button.

The firmware on the C8051F336 target microcontroller does not need to be customized to use the UART and communicate with ToolStick Terminal. The firmware on the microcontroller should write to the UART as it would in any standard application, and all of the translation is handled by the ToolStick Base Adapter.

## 6. Using the C8051F336 Daughter Card as a Development Platform

The prototyping area on the ToolStick C8051F336 daughter card makes it easy to interface to external hardware. All of the digital I/O pins are available so it is possible to create a complete system.

### 6.1. C8051F336 Pin Connections

It is important to note that if external hardware is being added, some of the existing components on the board can interfere with the signaling. The following is a list of port pins on the C8051F336 that are connected to other components:

- P0.1—This pin has a pull-down resistor (R7) to ground so that the IDAC output can be converted to a voltage. R7 can be safely removed from the daughter card if it is not needed.
- P0.4, P0.5—These pins are connected directly to the ToolStick Base Adapter for UART communication.
- P0.6, P0.7—These pins are connected directly to the ToolStick Base Adapter's GPIO pins. By default, these GPIO pins on the Base Adapter are high-impedance pins so they will not affect any signaling. Configuring these pins on the Base Adapter using the ToolStick Terminal to output pins or handshaking pins could affect signaling.
- P1.3—This pin is connected to the cathode of the green LED on the daughter card. The LED or the R2 resistor can be removed to disconnect the LED from the pin.
- P1.6—This pin is connected to the output of the potentiometer. The 0 ohm resistor can be removed to disconnect the potentiometer from the pin.

See the daughter card schematic in Section 7 for more information.

### 6.2. VREF Capacitor

On the C8051F336 devices, if VREF is generated internally, it is output to port pin P0.0. For VREF stability, it is highly recommended to place a capacitor on the VREF output pin. On the ToolStick C8051F336 Daughter Card, there are pads on the board (C3) to populate a 0603 surface mount capacitor. The firmware examples for the daughter card use VDD as VREF, so no external capacitor on P0.0 is necessary for proper operation.

### 6.3. C2 Pin Sharing

On the C8051F336, the debug pins, C2CK, and C2D, are shared with the pins /RST and P2.0 respectively. The daughter card includes the resistors necessary to enable pin sharing which allow the /RST and P2.0 pins to be used normally while simultaneously debugging the device. See Application Note "AN124: Pin Sharing Techniques for the C2 Interface" at [www.silabs.com](http://www.silabs.com) for more information regarding pin sharing.

# ToolStickF336DC

## 7. C8051F336 Daughter Card Schematic

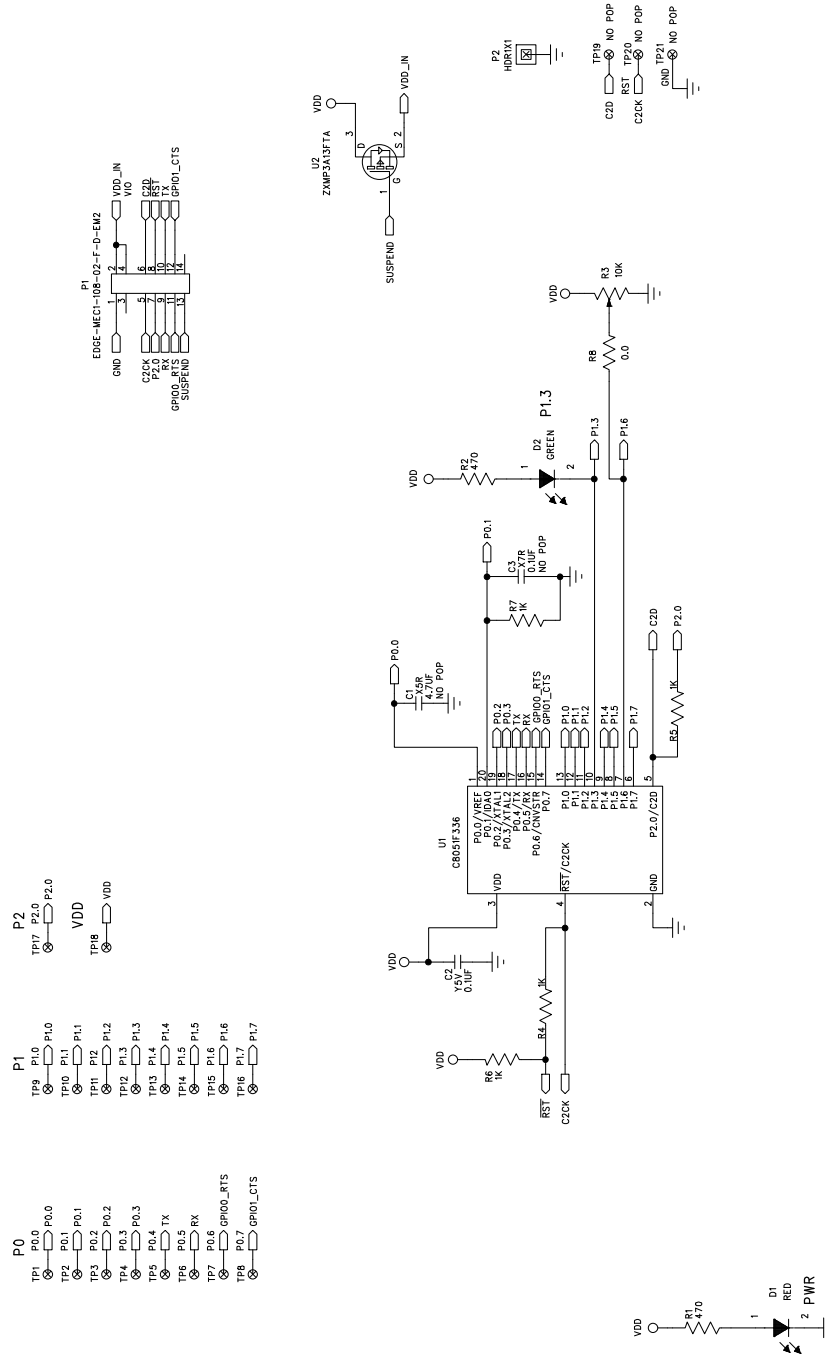

Figure 6. C8051F336 Daughter Card Schematic



## DOCUMENT CHANGE LIST

### Revision 0.1 to Revision 0.2

- Updated "4. Getting Started," on page 3 and "5. Software Overview," on page 3 with instructions for Simplicity Studio.

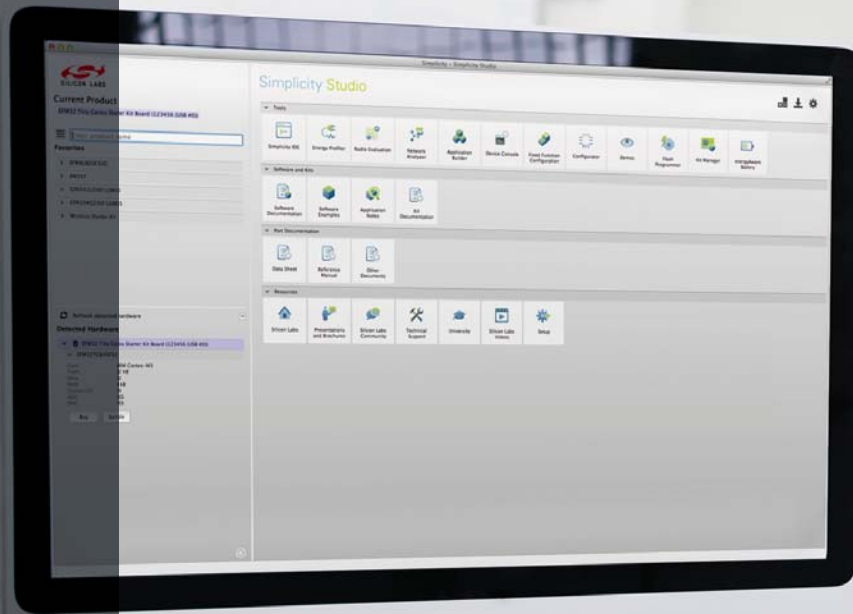

## Simplicity Studio

One-click access to MCU and wireless tools, documentation, software, source code libraries & more. Available for Windows, Mac and Linux!



**IoT Portfolio**  
[www.silabs.com/IoT](http://www.silabs.com/IoT)



**SW/HW**  
[www.silabs.com/simplicity](http://www.silabs.com/simplicity)



**Quality**  
[www.silabs.com/quality](http://www.silabs.com/quality)



**Support and Community**  
[community.silabs.com](http://community.silabs.com)

### Disclaimer

Silicon Laboratories intends to provide customers with the latest, accurate, and in-depth documentation of all peripherals and modules available for system and software implementers using or intending to use the Silicon Laboratories products. Characterization data, available modules and peripherals, memory sizes and memory addresses refer to each specific device, and "Typical" parameters provided can and do vary in different applications. Application examples described herein are for illustrative purposes only. Silicon Laboratories reserves the right to make changes without further notice and limitation to product information, specifications, and descriptions herein, and does not give warranties as to the accuracy or completeness of the included information. Silicon Laboratories shall have no liability for the consequences of use of the information supplied herein. This document does not imply or express copyright licenses granted hereunder to design or fabricate any integrated circuits. The products must not be used within any Life Support System without the specific written consent of Silicon Laboratories. A "Life Support System" is any product or system intended to support or sustain life and/or health, which, if it fails, can be reasonably expected to result in significant personal injury or death. Silicon Laboratories products are generally not intended for military applications. Silicon Laboratories products shall under no circumstances be used in weapons of mass destruction including (but not limited to) nuclear, biological or chemical weapons, or missiles capable of delivering such weapons.

### Trademark Information

Silicon Laboratories Inc., Silicon Laboratories, Silicon Labs, SiLabs and the Silicon Labs logo, CMEMS®, EFM, EFM32, EFR, Energy Micro, Energy Micro logo and combinations thereof, "the world's most energy friendly microcontrollers", Ember®, EZLink®, EZMac®, EZRadio®, EZRadioPRO®, DSPLL®, ISOModem®, Precision32®, ProSLIC®, SiPHY®, USBXpress® and others are trademarks or registered trademarks of Silicon Laboratories Inc. ARM, CORTEX, Cortex-M3 and THUMB are trademarks or registered trademarks of ARM Holdings. Keil is a registered trademark of ARM Limited. All other products or brand names mentioned herein are trademarks of their respective holders.



**SILICON LABS**

Silicon Laboratories Inc.  
 400 West Cesar Chavez  
 Austin, TX 78701  
 USA

<http://www.silabs.com>