

## HC-K-KV-M25(11-17)

Order No.: 1690639

The illustration shows version HC-K-KV-M20

<http://eshop.phoenixcontact.de/phoenix/treeViewClick.do?UID=1690639>

Plastic screw connection up to 5 bar, thread length: 8 mm, cable diameter: 11 - 17 mm, WAF 29, screw connection: M25

### Commercial data

GTIN (EAN)	 4 017918 822682
sales group	D290
Pack	25 pcs.
Customs tariff	39269097
Catalog page information	Page 520 (PC-2009)

### Product notes

WEEE/RoHS-compliant since:  
02/16/2006



<http://www.download.phoenixcontact.com>  
Please note that the data given here has been taken from the online catalog. For comprehensive information and data, please refer to the user documentation. The General Terms and Conditions of Use apply to Internet downloads.

### Technical data

#### General data

Type of the screw connection	M25
Cable gland material	Polyamide, RAL 7035
Seal material	Neoprene
Cable seal material	Neoprene
Wrench size, union nut	29 mm

Wrench size, support	29 mm
Thread type connection side 1	M25
Length of the connecting thread	8.00 mm
External cable diameter	11 mm ... 17 mm
Conductor sealing range	11.00 mm ... 17.00 mm
Tightening torque, union nut	7.50 Nm
Inflammability class acc. to UL 94	V2
Degree of protection	IP68, to 5 bar
Color	Silver gray
Ambient temperature (operation)	-20 °C ... 100 °C

### Certificates / Approvals



Certification

GOST

### Diagrams/Drawings

Dimensioned drawing

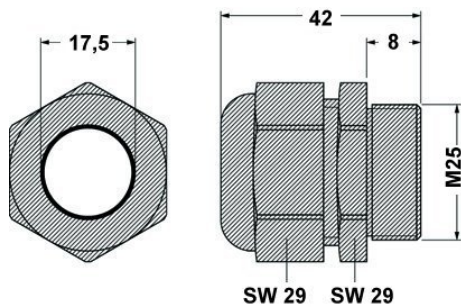

**Address**

PHOENIX CONTACT Deutschland GmbH  
Flachmarktstr. 8  
32825 Blomberg, Germany  
Phone +49 5235 3 12000  
Fax +49 5235 3 41200  
<http://www.phoenixcontact.de>



© 2010 Phoenix Contact  
Technical modifications reserved;