

Rectangular Package Discrete LED GREEN, 2 x 3 mm



R3GX

- ◆ Rectangular Package
- ◆ RoHS Compliant
- ◆ Water Clear (C), Diffused (D), and Tinted (T) Lenses
- ◆ Available in Standard Lead Frame style
- ◆ Ideal for Status Indication and Bar Graph Displays
- ◆ Recommended for Bivar H-480C holder assemblies

Bivar Rectangular 2 x 3mm Package LED may be used in almost any application and is ideal for creating bar graph displays when arranged in linear LED arrays. Bivar offers water clear LED lens for maximum light output, diffused LED lens for uniform light output, and tinted lens to identify the color of the LED. The Standard Lead frame LED is ideal for vertical spacer assemblies and Right Angle Holder assemblies that require lead bends.

Part Number	Material	Emitted Color	Peak. Wavelength λ_p (nm) TYP.	Lens Appearance	Viewing Angle
R3GC	GaP/GaP	GREEN	568nm	Water Clear	80°
R3GD				Green Diffused	100°
R3GT				Green Tinted	80°

Outline Dimensions

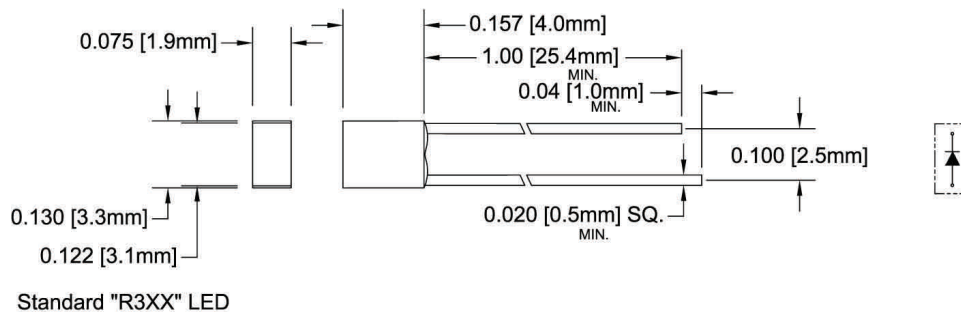

Recommended Mounting
Hole Size = $\varnothing.032^{+.003}_{-.002}$

Outline Drawings Notes:

1. All dimensions are in inches [millimeters].
2. Standard tolerance: ± 0.010 " unless otherwise noted.
3. Tolerance of overall epoxy outline: ± 0.020 " unless otherwise noted.
4. Epoxy meniscus may extend to 0.060" max.

Part Number Designation

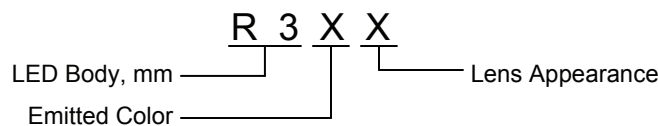

Bivar reserves the right to make changes at any time without notice.

Absolute Maximum Ratings

T_A = 25°C unless otherwise noted

Power Dissipation	80 mW
Forward Current (DC)	30 mA
Peak Forward Current ¹	150 mA
Reverse Voltage	5 V
Operating Temperature Range	-25 ~ +85°C
Storage Temperature Range	-30 ~ +100°C
Lead Soldering Temperature (3 mm from the base of the epoxy bulb) ²	260°C

Notes: 1. 10% Duty Cycle, Pulse Width ≤ 0.1 msec. 2. Solder time less than 5 seconds at temperature extreme.

Electrical / Optical Characteristics

T_A = 25°C & I_F = 20 mA unless otherwise noted

Part Number	Forward Voltage (V) ¹			Recommend Forward Current (mA)			Reverse Current (μA)	Dominant Wavelength (nm) ²			Luminous Intensity I _v (mcd)			Viewing Angle 2Θ ^{1/2} (deg)
	MIN	TYP	MAX	MIN	TYP	MAX	MAX	MIN	TYP	MAX	MIN	TYP	MAX	TYP
R3GC	/	2.1	2.8	/	20	/	100	/	/	/	/	8	/	80
R3GD								/	/	/	/	6	/	100
R3GT								/	/	/	/	8	/	80

Notes: 1. Tolerance of forward voltage : ±0.05V. 2. Tolerance of dominant wavelength : ±1.0nm.

Typical Electrical / Optical Characteristics

$T_A = 25^\circ\text{C}$ unless otherwise noted

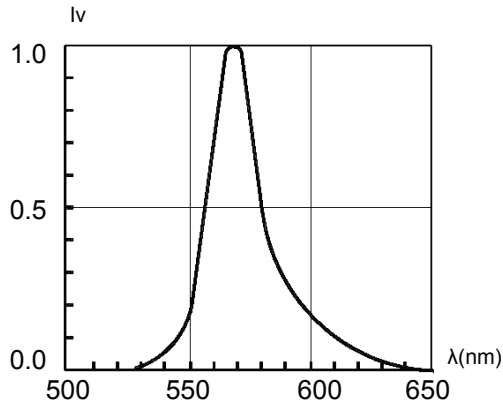

Fig. 1 Relative Luminous Intensity vs. Wavelength @ 20mA

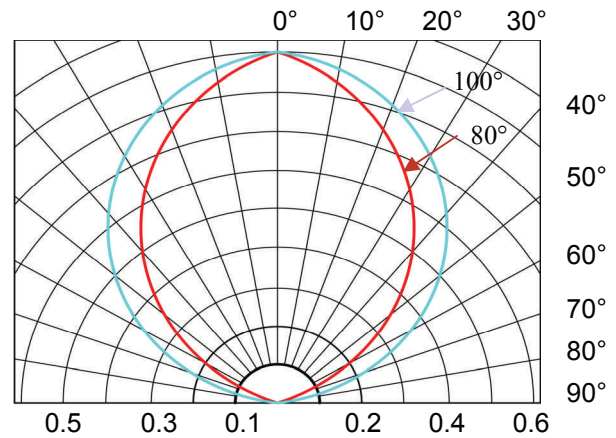

Fig. 2 Directivity Radiation Diagram

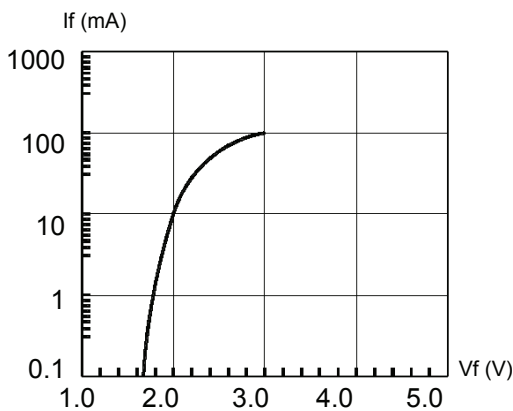

Fig. 3 Forward Current vs. Forward Voltage

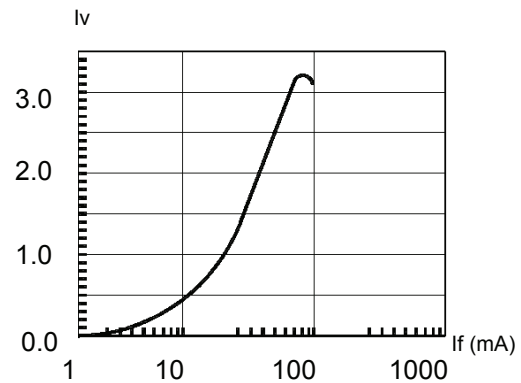

Fig. 4 Relative Luminous Intensity vs. Forward Current Normalize @ 20 mA

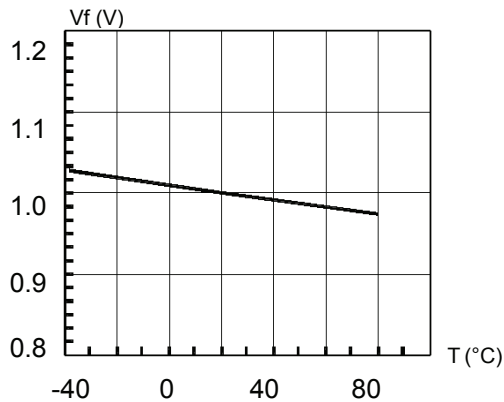

Fig. 5 Forward Voltage vs. Temperature

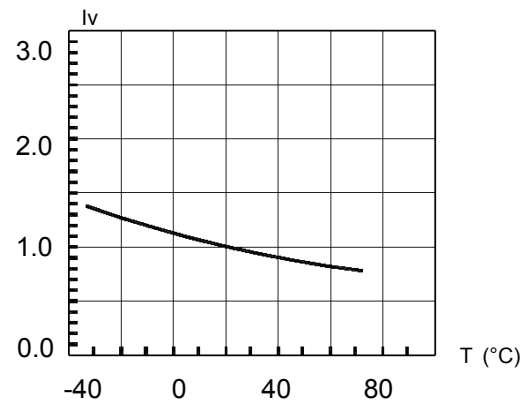

Fig. 6 Relative Luminous Intensity vs. Temperature

Bivar reserves the right to make changes at any time without notice.

Rectangular Package Discrete LED GREEN, 2 x 3 mm



Recommended Soldering Conditions



Recommended Lead Free Wave Soldering Profile	
Preheat Temperature: 100°C Max.	Peak Temperature: 260°C Max.
Preheat Time: 20 ~ 50 Seconds	Solder Time Above 217°C: 5 Seconds Max.
Note: Turn off top heater at preheat to prevent the lamp body directly exposed to the heat source.	

Packaging and Labeling Plan

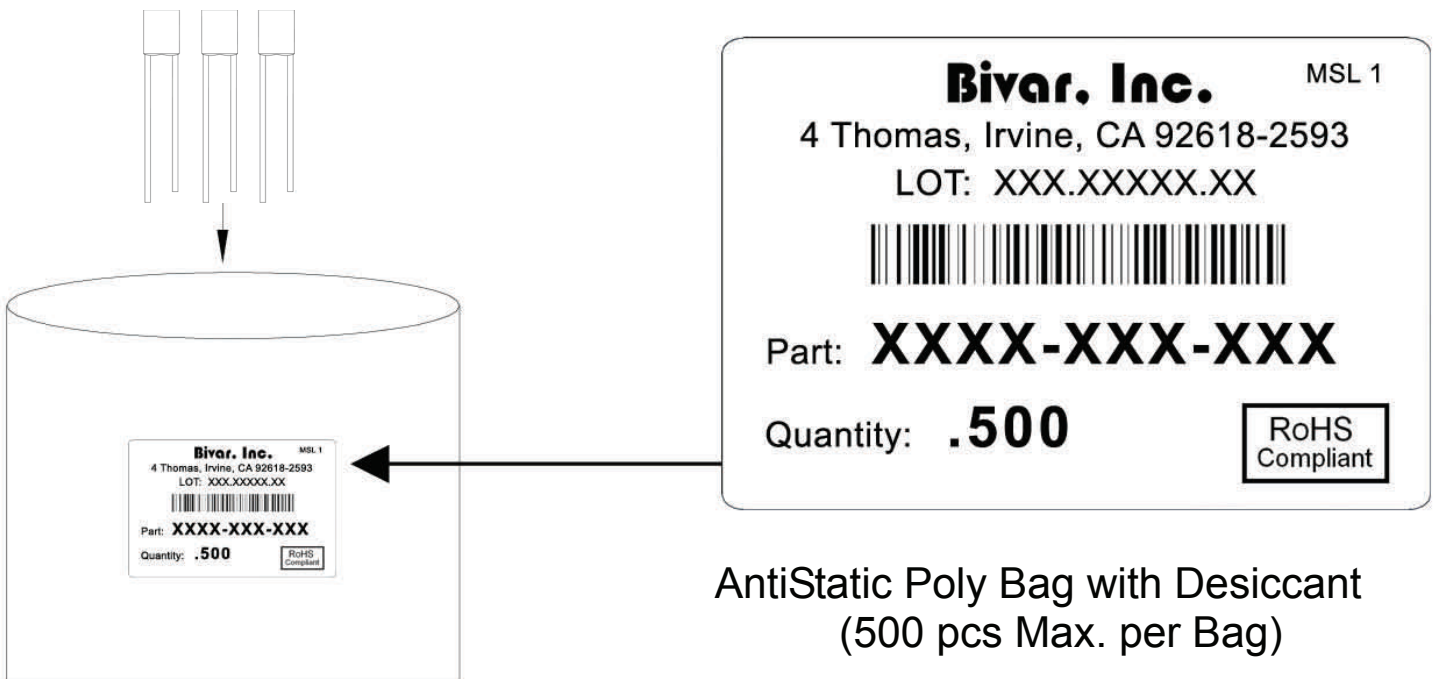

Bivar reserves the right to make changes at any time without notice.