

**100 Series
Media Converter &
Industrial Ethernet Switches**

**User Manual &
Installation
Guide**

Industrial Media Converter and Ethernet Switch Installation Guide

- | | | | |
|---------------------|---------------------|-----------------|---------------------|
| 102MC-XX | 105TX | 106FX2 | 110FX2-XX-YY |
| 102MCE-XX-YY | 105TX-SL | 108TX | 111FX3-XX-YY |
| 104TX | 105FX-XX | 108TX-HV | 112FX4-XX-YY |
| | 105FXE-XX-YY | | 114FX6-XX-YY |
| | | | 116TX |

Where: XX=ST or SC and YY= 15, 40 or 80



Copyright, © N-TRON Corporation, 2015
3101 International Drive, Building 6
Mobile, AL USA 36606

All rights reserved. Reproduction, adaptation, or translation without prior written permission from N-TRON Corporation is prohibited, except as allowed under copyright laws.

Ethernet is a registered trademark of Xerox Corporation. All other product names, company names, logos or other designations mentioned herein are trademarks of their respective owners.

The information contained in this document is subject to change without notice. N-TRON Corporation makes no warranty of any kind with regard to this material, including, but not limited to, the implied warranties of merchantability or fitness for a particular purpose. In no event shall N-TRON Corporation be liable for any incidental, special, indirect or consequential damages whatsoever included but not limited to lost profits arising out of errors or omissions in this manual or the information contained herein.

Contact Information

N-TRON Corporation
3101 International Drive, Building 6
Mobile, AL 36606
TEL: (251) 342-2164
FAX: (251) 342-6353
WEBSITE: www.redlion.net
E-MAIL: customer.service@redlion.net

GENERAL SAFETY WARNINGS

GÉNÉRAL AVERTISSEMENTS DE SÉCURITÉ

WARNING: Do not operate the equipment in the presence of flammable gasses or fumes. Operating electrical equipment in such an environment constitutes a definite safety hazard.

AVERTISSEMENT: Ne pas utiliser le matériel en présence de gaz ou de vapeurs inflammables. L'utilisation de matériel électrique dans un tel environnement constitue un danger certain.

WARNING: If the equipment is used in the manner not specified by N-TRON Corporation, the protection provided by the equipment may be impaired.

AVERTISSEMENT: Si l'équipement est utilisé d'une manière non spécifiée par N-Tron Corporation, la protection fournie par l'équipement peut être compromise.

WARNING: Do not perform any services on the unit unless qualified to do so. Do not substitute unauthorized parts or make unauthorized modifications to the unit.

AVERTISSEMENT: Ne pas effectuer de services sur l'unité à moins d'être qualifié pour le faire. Ne pas remplacer avec des pièces non autorisées ou faire des modifications non autorisées sur l'appareil.

WARNING: Do not operate the unit with the any cover removed.

AVERTISSEMENT: Ne pas utiliser l'appareil avec n'importe quel couvercle retiré.

WARNING: Properly ground the unit before connecting anything else to the unit. Units not properly grounded may result in a safety risk and could be hazardous and may void the warranty. See the grounding technique section of this user manual for proper ways to ground the unit.

AVERTISSEMENT: Correctement à la terre de l'unité avant tout raccordement à l'unité. Unités pas correctement mise à la terre peut entraîner un risque de sécurité et pourraient être dangereux et peut annuler la garantie. Voir la section technique de mise à la terre de ce mode d'emploi des moyens appropriés à la masse de l'appareil.

WARNING: Do not operate the equipment in a manner not specified by this manual.

AVERTISSEMENT: Ne pas faire fonctionner l'équipement d'une manière non spécifiée par ce manuel.

ENVIRONMENTAL SAFETY



WARNING: Disconnect the power and allow to cool 5 minutes before touching.

AVERTISSEMENT: Déconnectez le câble d'alimentation et laissez refroidir 5 minutes avant de la toucher.

ELECTRICAL SAFETY



WARNING: Disconnect the power cable before removing the end plates.

AVERTISSEMENT: Débranchez le câble d'alimentation avant de retirer les plaques d'extrémité.

WARNING: Do not operate the unit with the end plates removed.

AVERTISSEMENT: Ne pas faire fonctionner l'appareil avec les plaques d'extrémité supprimées.

WARNING: Never install or work on electrical equipment or cabling during periods of lightning activity.

AVERTISSEMENT: Ne jamais installer ou travailler sur équipement électrique ou de câblage pendant les périodes d'activité de la foudre.

WARNING: Do not perform any services on the unit unless qualified to do so.

AVERTISSEMENT: Ne pas effectuer de services sur l'appareil si vous n'êtes pas qualifié pour le faire.

WARNING: Observe proper DC Voltage polarity when installing power input cables. Reversing voltage polarity can cause permanent damage to the unit and void the warranty.

AVERTISSEMENT: Respecter la polarité correcte de tension DC lors de l'installation des câbles d'alimentation d'entrée. Le renversement de la polarité de tension peut causer des dommages permanents à l'appareil et annule la garantie.

HAZARDOUS LOCATION INSTALLATION REQUIREMENTS

1. This equipment is suitable for use in Class I, Div 2, Groups A, B, C, and D, or unclassified or non-hazardous locations only.
Cet équipement est adapté seulement pour utilisation dans la classe I, Division 2, Groupes A, B, C, D ou seulement dans les endroits non-dangereux.
2. **WARNING:** Explosion Hazard - Substitution of components may impair suitability for Class I, Division 2.
AVERTISSEMENT – RISQUE D’EXPLOSION – La substitution de tout composant peut nuire à la conformité de Classe I, Division 2.
3. **WARNING** – Explosion Hazard, do not disconnect while circuit is live unless area is known to be non-hazardous.
AVERTISSEMENT – RISQUE D’EXPLOSION - Ne débranchez pas le module lorsque le circuit est sous tension, sauf si la zone est connue pour être non dangereuse.
4. **WARNING** – Explosion Hazard – Do not replace the device unless power has been switched off or the area is known to be non-hazardous.
AVERTISSEMENT – RISQUE D’EXPLOSION – Ne pas remplacer l’appareil à moins que l’alimentation est coupée ou que la zone est connue pour être non dangereuse.
5. For 102MC, 105FX, 106FX and 108TX: Use 60/75°C rated copper wire, (0.22Nm) 2 inch-lbs. tightening torque for field installed connectors.
Utilisez fil de cuivre classé 60/75 °C, (0.22Nm) 2 pouces-livres Couple de serrage pour les connecteurs installés sur le terrain.
6. For 104TX, 105TX and 105TX-SL: Use 95°C rated copper wire, (0.22Nm) 2 inch-lbs. tightening torque for field installed conductors.
Utilisez fil de cuivre classé 95 °C, (0.22Nm) 2 pouces-livres Couple de serrage pour les connecteurs installés sur le terrain.
7. For the 116TX: Use 105°C rated copper wire (0.22Nm) 2 inch-lbs. tightening torque for field installed conductors.
Utilisez fil de cuivre classé 105 °C, (0.22Nm) 2 pouces-livres Couple de serrage pour les connecteurs installés sur le terrain.
8. **WARNING:** Install only in accordance with Local & National Codes of Authorities having Jurisdiction.
ALERTE: Installez uniquement en conformité avec les codes locaux et nationaux des autorités compétentes.
9. Class I, Div 2 Installations require that power connections must be current-limited at the power source with an in-line fuse rated at 0.5A.
Les installations de Classe I, Division 2 nécessitent que les connexions électriques doivent être au courant limité à la source d'alimentation avec un fusible en ligne évalué à 0.5A

10. Class I, Div 2 installations require that all devices connected to this product must be UL listed for the area in which it is installed.
Les installations de Classe I, Division 2 exigent que toutes les unités connectées à ce produit doivent être énumérées UL pour la zone dans laquelle il est installé.
11. All circuits must have a common disconnect and be connected to the same pole of the disconnect.
Tous les circuits doivent avoir un décalage commun et doivent être connecté au même pôle de la déconnexion.
12. Limited Operating Voltage: 12-30V for Class I, Div. 2 installations.
Tension de fonctionnement limité: 12-30V pour installation de Classe I, Div. 2.
13. **WARNING:** For products 110, 111, 112 and 114: Exposure to some chemicals may degrade the sealing properties of materials used in the Sealed Relay Device. Relay U13.
AVERTISSEMENT: Pour 110, 111, 112 et 114: L'exposition à certains produits chimiques peut dégrader les propriétés d'étanchéité des matériaux utilisés dans le dispositif de relais scellé. Relais U13.

100 Series Industrial Ethernet Switches

The 100 Series Unmanaged Industrial Ethernet Switches support high speed layer 2 switching between ports. This series of switches are housed in a ruggedized aluminum enclosure, and provide Category-5 compliant 10/100-BaseT connections for high performance network design, and hub/repeater upgrades.

All fiber products utilize the IEEE compliant SC or ST duplex connectors for fiber optic communications. All 10/100Base-TX ports utilize the RJ45 shielded connectors.

The 102MC/MCE is a two-port unmanaged media converter that converts 10/100BaseTX copper to 100BaseFX full duplex fiber.

The 104TX, 105TX and 108TX are affordable and share a small footprint. Each switch is capable of auto negotiating 10/100 Mb and half/full duplex communications. The five-port 105TX-SL offers the same functionality and is distinguished by its ultra-slim enclosure.

The 105FX/FXE has 4 ports similar to the 104TX, plus additional multimode fiber optic up-link port(s), capable of 2 Kilometers of 100 Mb communications for the FX models, and up to 80 Kilometers for the FXE models without the use of repeaters.

The 106FX2/FXE2 has 4 10/100BaseTX RJ-45 auto sensing ports and 2 100BaseFX ports with ST or SC connectors, capable of 2 Kilometers of 100 Mb communications for the FX models, and up to 80 Kilometers for the FXE models without the use of repeaters.

The 110FX2/FXE2 has 8 10/100BaseTX RJ-45 auto sensing ports and 2 100BaseFX ports with ST or SC connectors, capable of 2 Kilometers of 100 Mb communications for the FX models, and up to 80 Kilometers for the FXE models without the use of repeaters.

The 111FX3/FXE3 has 8 10/100BaseTX RJ-45 auto sensing ports and 3 100BaseFX ports with ST or SC connectors, capable of 2 Kilometers of 100 Mb communications for the FX models, and up to 80 Kilometers for the FXE models without the use of repeaters.

The 112FX4/FXE4 has 8 10/100BaseTX RJ-45 auto sensing ports and 4 100BaseFX ports with ST or SC connectors, capable of 2 Kilometers of 100 Mb communications for the FX models, and up to 80 Kilometers for the FXE models without the use of repeaters.

The 114FX6/FXE6 has 8 10/100BaseTX RJ-45 auto sensing ports and 6 100BaseFX ports with ST or SC connectors, capable of 2 Kilometers of 100 Mb communications for the FX models, and up to 80 Kilometers for the FXE models without the use of repeaters.

The 116TX has 16 10/100BaseTX RJ-45 auto sensing. Each port is capable of auto negotiating 10/100 Mb and half/full duplex communications.

Key Features

- Full IEEE 802.3 & 100Base-FX Compliance
- Extended Environmental Specifications
- Support for Full/Half Duplex Operation
- LED Link/Activity Status Indication
- Autonegotiation, Autosensing Speed, Duplex, and Flow Control
- Up to 3.2 Gb/s Maximum Throughput
- Industry Standard 35mm DIN Rail Mounted Enclosure

PACKAGE CONTENTS

Please make sure the package contains the following items:

1. 100 Series Media Converter or Ethernet Switch
2. Instruction Sheet

Contact your carrier if any items are damaged.

UNPACKING

Remove all the equipment from the packaging, and store the packaging in a safe place. File any damage claims with the carrier.

CLEANING

Clean only with a damp cloth.

INSTALLATION

Read the following warning before beginning the installation:

WARNING
AVERTISSEMENT



WARNING: Never install or work on electrical equipment or cabling during periods of lightning activity.
AVERTISSEMENT: Ne jamais installer ou de travailler sur un équipement électrique ou de câblage pendant les périodes d'activité de la foudre.

WARNING: Do not operate the equipment in the presence of flammable gasses or fumes. Operating electrical equipment in such an environment constitutes a definite safety hazard.
AVERTISSEMENT: Ne pas utiliser le matériel en présence de gaz ou de vapeurs inflammables. L'utilisation de matériel électrique dans un tel environnement constitue un danger certain.

LASER SAFETY (MCE and FXE models only -40 and -80)



CAUTION: CLASS 1 LASER PRODUCT. Do not stare into the laser!
ATTENTION: PRODUIT LASER CLASSE 1. Ne pas regarder dans le laser!

DIN-Rail Mounting

Install the unit in a standard DIN rail. Recess the unit to allow at least 2" of horizontal clearance for CAT5e cable bend radius.

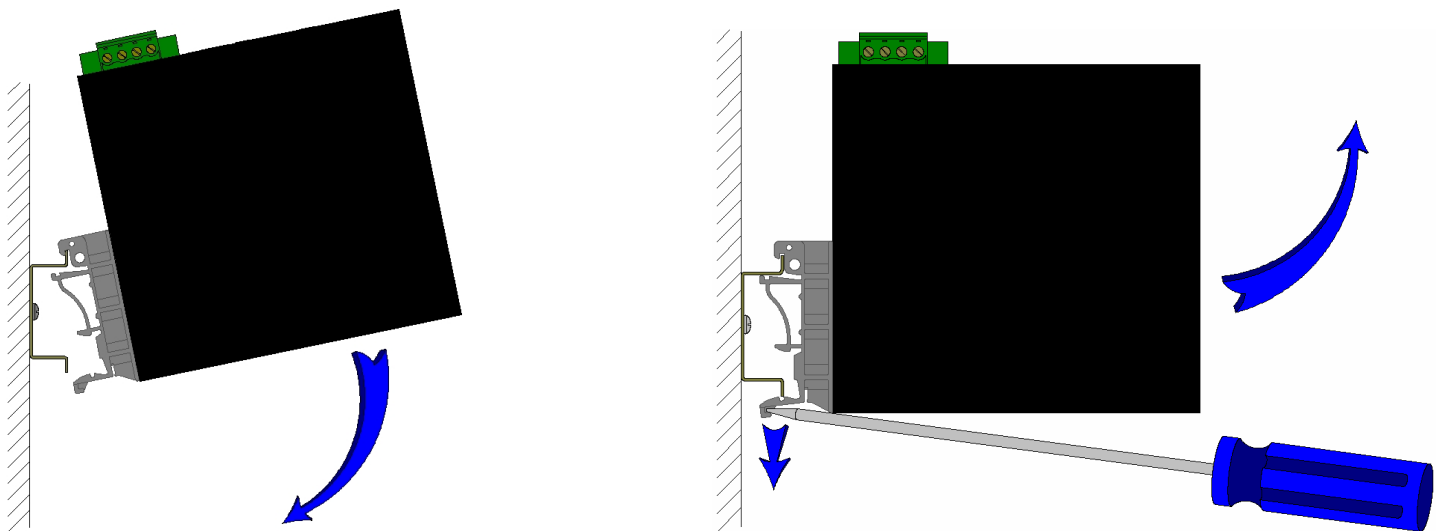

To install the plastic clip units to 35mm industrial DIN rail, place the top edge of the included mounting bracket on the back of the unit against the DIN rail at a 15° angle as shown. Rotate the bottom of the unit to the back (away from you) until it snaps into place.

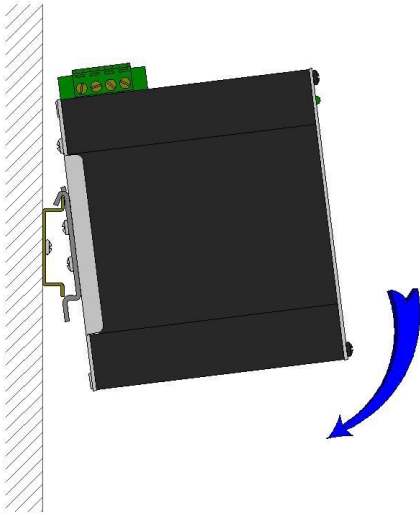

To remove the plastic clip units from the 35mm industrial DIN rail, place a flat head screwdriver into the release clip found at the bottom of the unit, and apply downward force on the clip until it disengages from the bottom of the unit from the DIN rail. Rotate the bottom of the unit towards you and up at an approximate 15° upward angle to completely remove the unit.

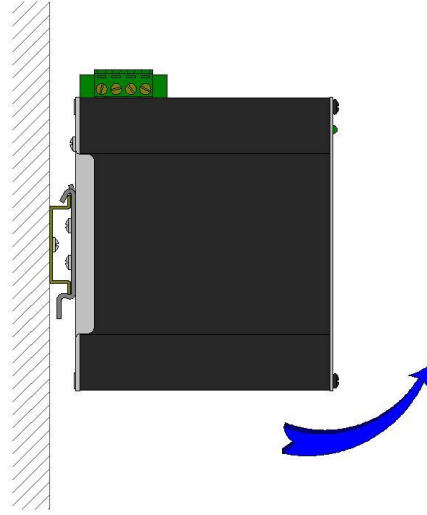

To install the metal clip units to 35mm industrial DIN rail, place the top edge of the included mounting bracket on the back of the unit against the DIN rail at a 15° angle as shown. Rotate the bottom of the unit to the back (away from you) until it snaps into place.

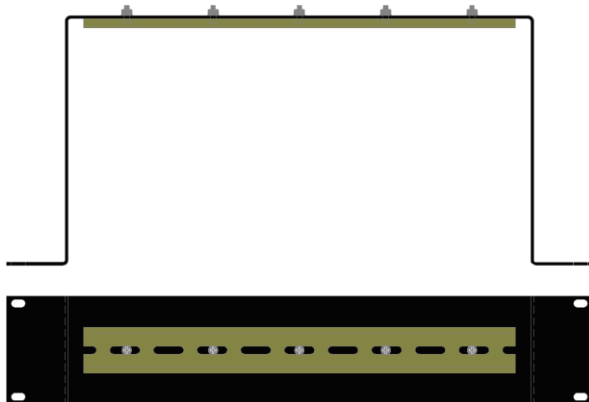

URMK

To remove the metal clip units from the 35mm industrial DIN rail, pull forward on the unit until it disengages from the bottom of the DIN rail. Rotate the bottom of the unit towards you and up at an approximate 15° upward angle to completely remove the unit.

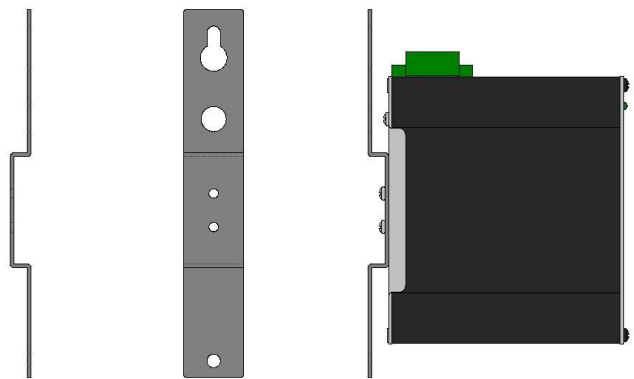

1000-PM

Most N-Tron™ products are designed to be mounted on industry standard 35mm DIN rail. However, DIN rail mounting may not be suitable for all applications. Our Universal Rack Mount Kit (P/N: URMK) may be used to mount the 100 Series enclosures to standard 19" racks, and our Panel Mount Assembly (P/N: 1000-PM) may be used to mount the metal clip versions of the 100 Series enclosures to a panel or any other flat surface. NOTE: the 1000-PM will only work with the factory installed –MDR metal clip options and it is not acceptable for the 116TX units.

FRONT PANEL

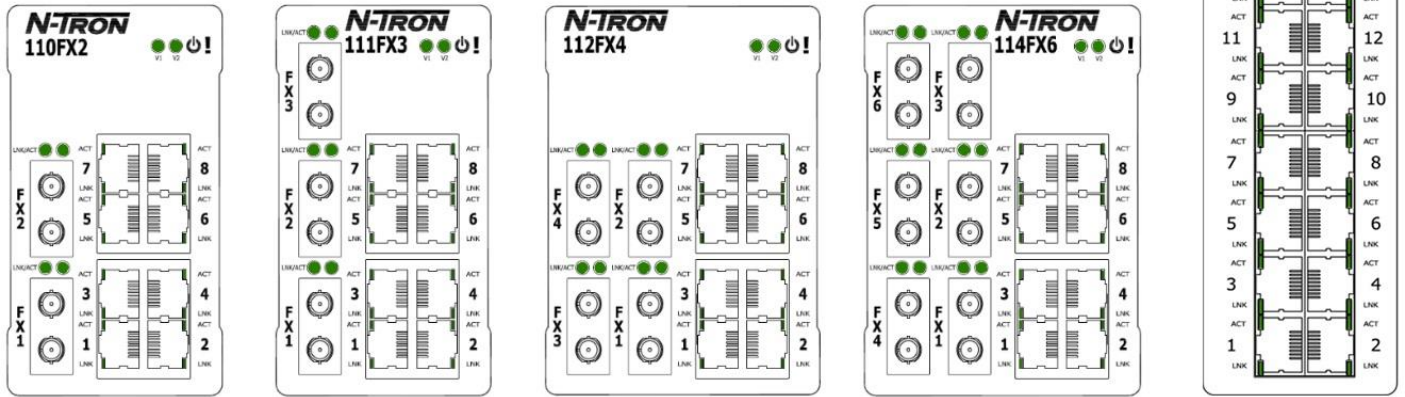
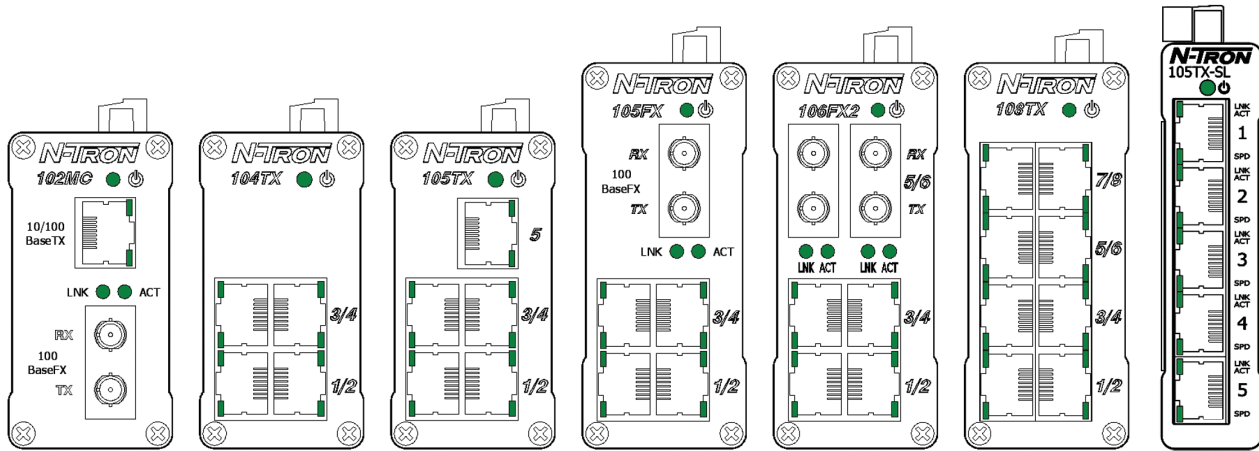

LED Status

For 102MC, 104TX, 105FX, 106FX2, 108TX and 105TX-SL

From Top to Bottom:

SPD
LNK/ACT
RJ45 Ports
⏻

Speed LED
Link/Activity LED
Auto sensing 10/100BaseT Connection
Green LED lights when Power is connected

NOTE: The top LED indicates Link/Activity (LNK/ACT), and the lower LED indicates Speed (SPD) status.

LED's: The table below describes the operating modes:

LED	Color	Description
⏻	ON	Power is Applied.
	OFF	Power is OFF.
LNK/ACT	ON	Link established, no Activity on cable.
	BLINKING	Link established, Activity on cable
	OFF	No link activity on cable.
SPD	ON	LINK is 100Mbps.
	OFF	Link is 10Mbps.

For the 110FX, 111FX3, 112FX4, 114FX6 and 116TX

LNK/ACT
RJ45 Ports
⏻

Link/Activity LED

Auto sensing 10/100BaseT Connection

The Green LED lights when Power is connected. In the case of the 110FX2, 111FX3, 112FX4 and 114FX6 there are two independent power LEDs labeled V1 and V2 corresponding to VIN1 and VIN2, respectively.

NOTE: The top LED of the RJ45 connector indicates Activity (ACT), and the lower LED indicates Link (LNK) status. Also, the 100BaseFX ports labeled FX1 through FX6 show link (LNK) and activity status from left to right.

LED's: The table below describes the operating modes:

LED	Color	Description
⏻	ON	Power is Applied.
	OFF	Power is OFF.
LNK	ON	Link established.
	OFF	No link activity on cable.
ACT	BLINKING	Activity on cable.
	OFF	No activity on cable.

	OFF	No link activity on cable.
--	-----	----------------------------

APPLYING POWER

- **102MC, 104TX, 105TX, 105FX, 106FX2, 108TX, and 116TX Power Connector (Top View)**

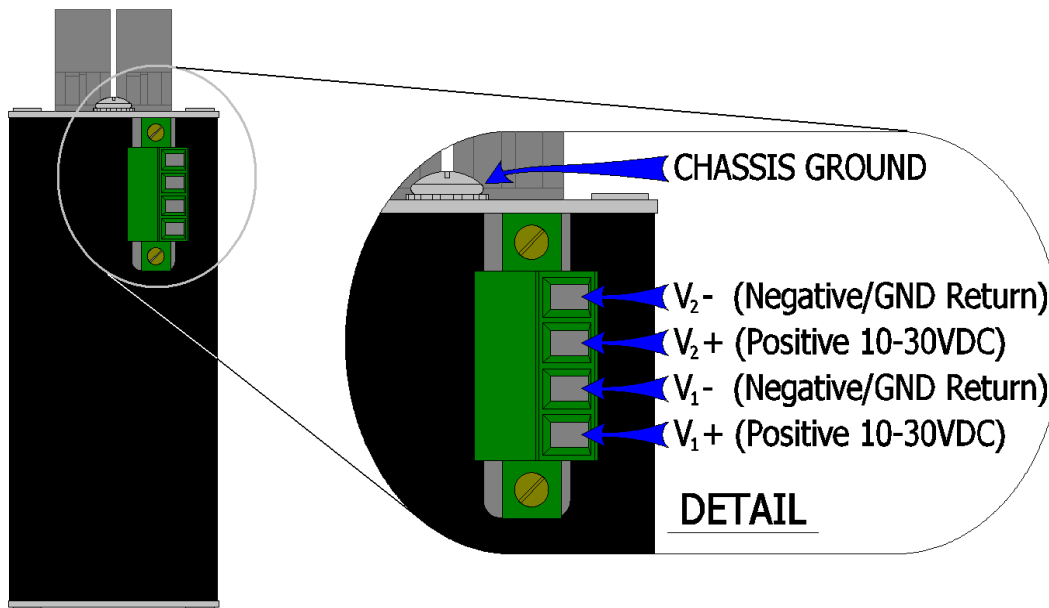

- **110FX2, 111FX3, 112FX4, and 114FX6 Power Connector (Top View)**
(must be powered by Class 2 source only)

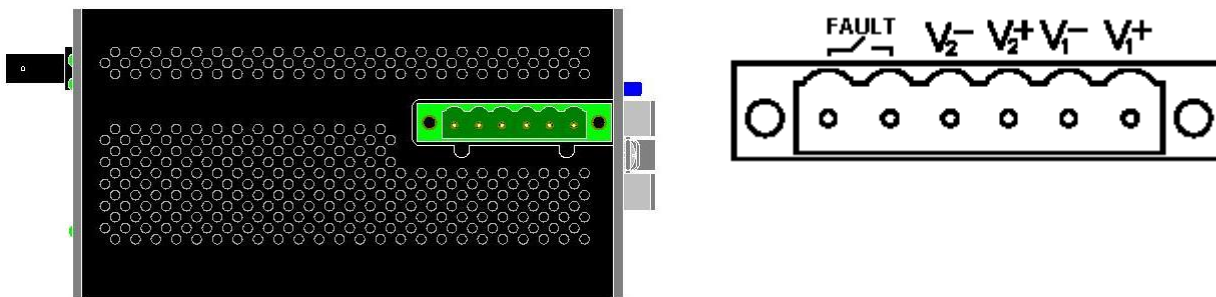

Unscrew & Remove the DC Voltage Input Plug from the top header. Install the DC Power Cables into the Plug (observing polarity on unit). Plug the Voltage Input Plug back into the top header. Tightening torque for the terminal block power plug is **0.22 Nm/0.162 Pound Foot**.

All LED's will flash ON Momentarily. Verify the Power LED stays ON (GREEN).

Note: Either V_1 or V_2 can be connected to power for minimal operation. For redundant power operation, V_1 and V_2 plugs must be connected to separate DC Voltage sources. Use wire sizes of 16-28 gauge. The power cord should be limited to less than 10 meters in order to ensure optimum performance.

In the case of the 110FX2, 111FX3, 112FX4 and 114FX6, the Fault pins on the power connector can be used for an alarm contact. The current carrying capacity is 1A at 24VDC. It is normally open and the relay closes when a power fault condition occurs on one of the redundant power source inputs. These pins can be used to connect an external warning device such as a light in order to provide an external alarm.

Recommended 24V DC Power Supplies, similar to:

100-240VAC: N-Tron NTPS-24-1.3, DC 24V/1.3

• **105TX-SL** (Top View)

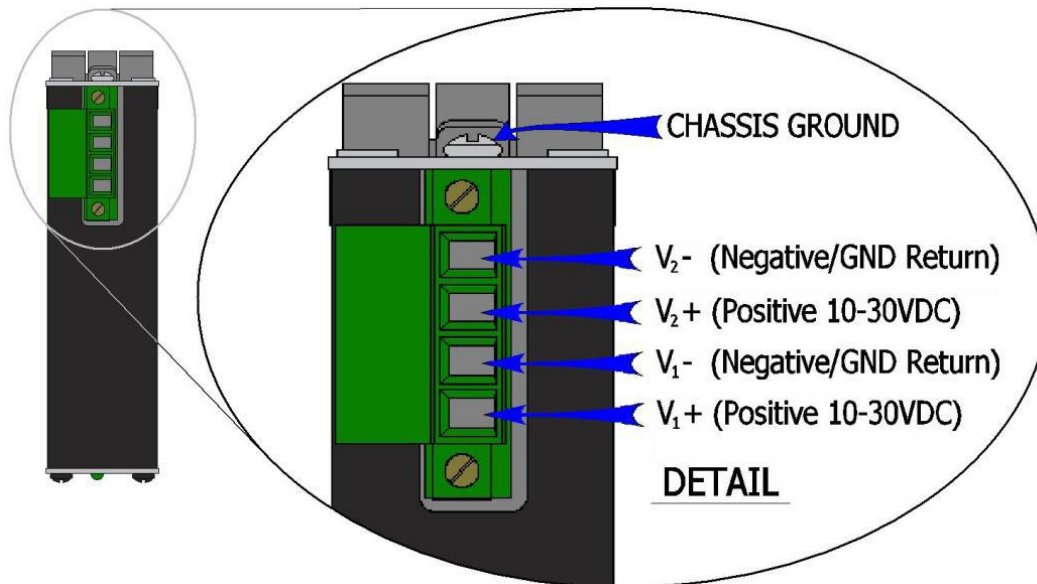

Unscrew & Remove the DC Voltage Input Plug from the top header. Install the DC Power Cables into the Plug (observing polarity on unit). Plug the Voltage Input Plug back into the top header. Tightening torque for the terminal block power plug is **0.5 Nm/0.368 Pound Foot**.

All LEDs will flash ON Momentarily. Verify the Power LED stays ON (GREEN).

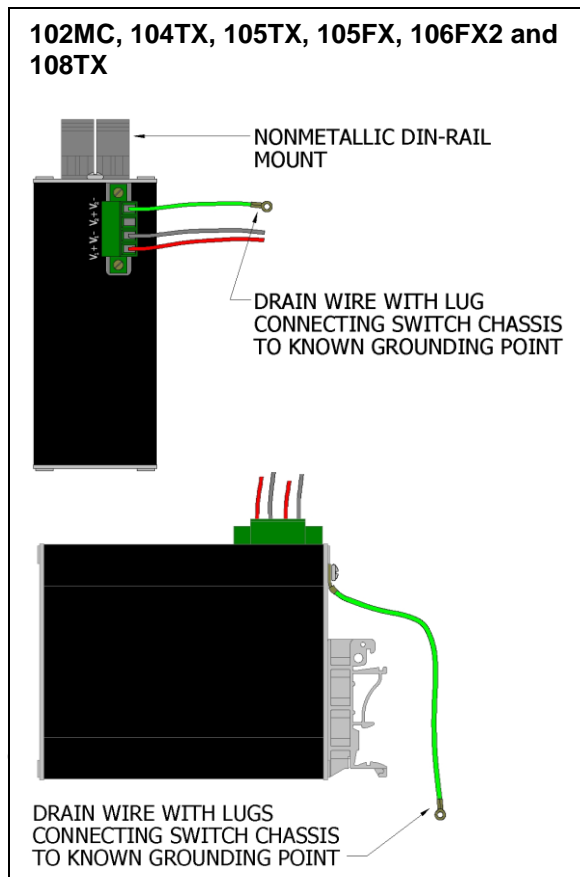

Note: Either V₁ or V₂ can be connected to power for minimal operation. For redundant power operation, V₁ and V₂ plugs must be connected to separate DC Voltage sources. Use wire sizes of 12-28 gauge. The power cord should be limited to less than 10 meters in order to ensure optimum performance.

Recommended 24V DC Power Supplies, similar to:
 100-240VAC: N-Tron NTPS-24-1.3, DC 24V/1.3A

N-TRON SWITCH GROUNDING TECHNIQUES FOR 100 SERIES

The grounding philosophy of any control system is an integral part of the design. N-Tron switches are designed to be grounded, but the user has been given the flexibility to float the switch when required. The best noise immunity and emissions (i.e. CE) are obtained when the N-Tron switch chassis is connected to earth ground via a drain wire. Some N-Tron switches have metal din-rail brackets that can ground the switch

if the din-rail is grounded. In some cases, N-Tron switches with metal brackets can be supplied with optional plastic brackets if isolation is required.

Users may run a drain wire & lug from the screw provided on the back face of the enclosure. In the event the provided grounding screw has been lost, care should be taken to limit the penetration of the outer skin by less than 1/4". Failure to do so may cause irreversible damage to the internal components of the switch.

Note: Ensure the power supply is grounded properly before applying power to the grounded switch. This may be verified by using a voltmeter to determine that there is no voltage difference between the power supply's negative output terminal and the chassis grounding point of the switch.

As an alternative grounding method, both V- legs of the power input connector are connected to chassis internally on the PCB. Connecting a drain wire to earth ground from one of the V- terminal plugs as shown here will ground the switch and the chassis. The power leads from the power source should be limited to 3 meters or less in length.

If the use of shielded cables is required, it is generally recommended to only connect the shield at one end to prevent ground loops and interfere with low level signals (i.e. thermocouples, RTD, etc.). Cat5e cables manufactured to EIA-568A or 568B specifications are required for use with N-Tron Switches.

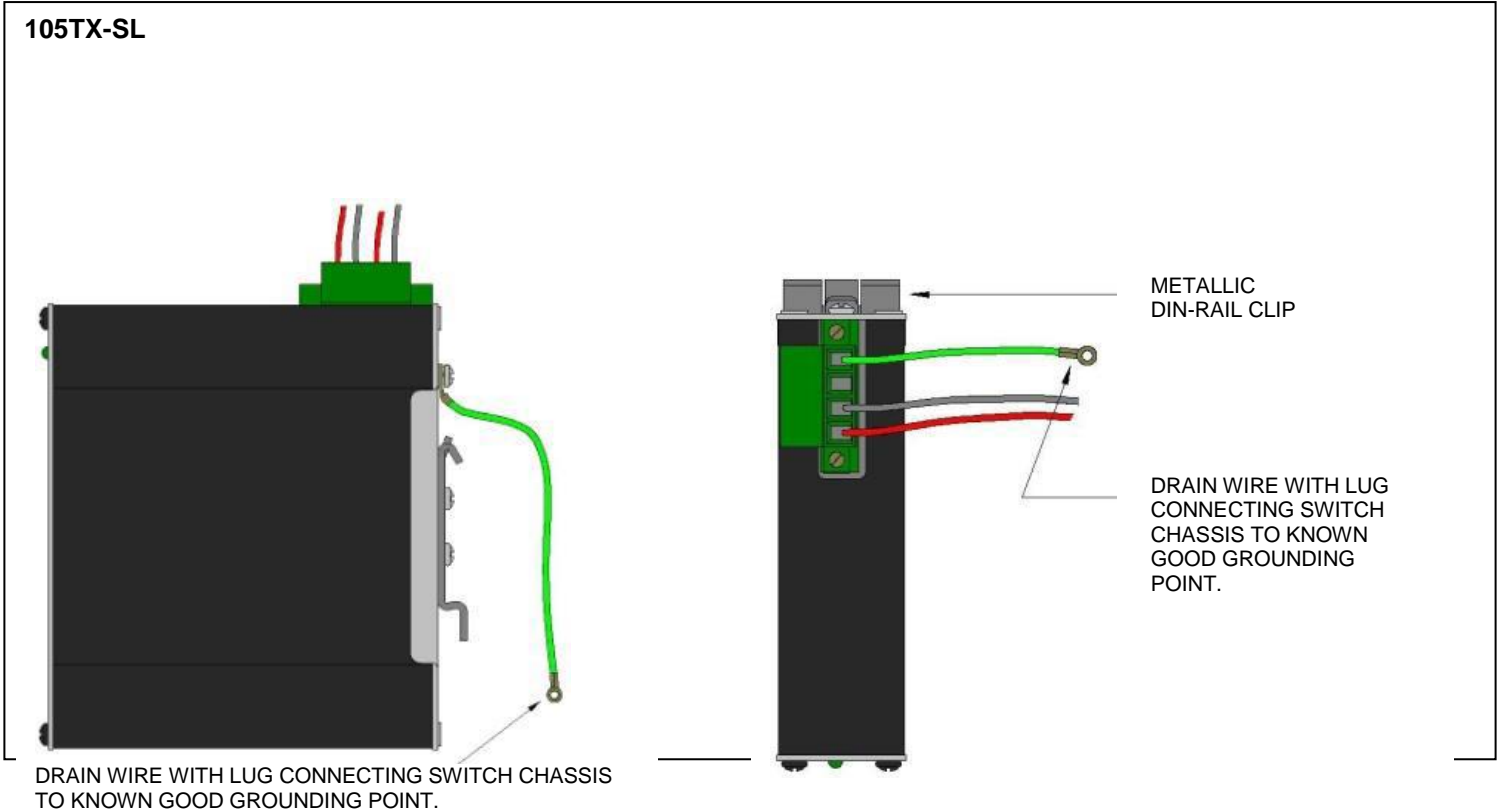
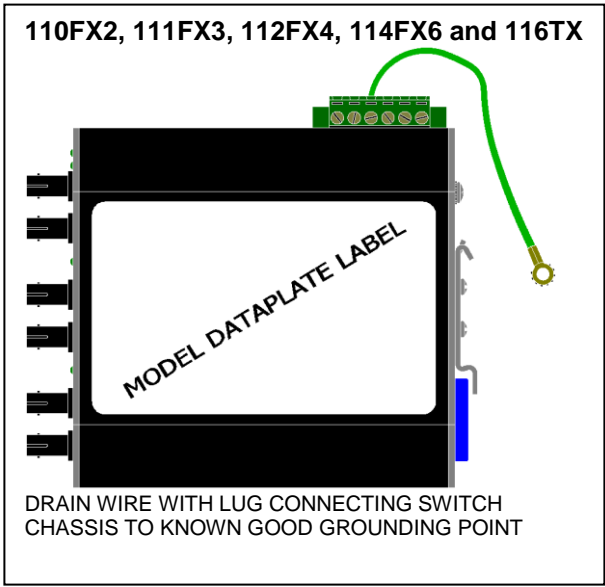



In the event all Cat5e patch cable distances are small (i.e. All Ethernet devices are located the same local cabinet and/or referenced to the same earth ground), it is permissible to use fully shielded cables terminated to chassis ground at both ends in systems void of low level analog signals.

RJ45 CONNECTOR CRIMP SPECIFICATIONS

Please reference the illustration for your Cat5 cable specifications.

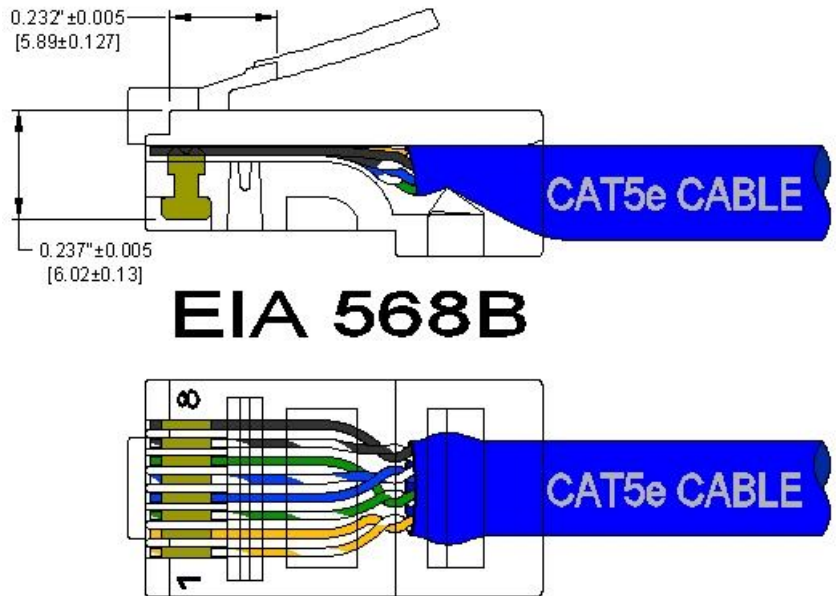

CONNECTING THE UNIT

For FX/FXE units, remove the dust cap from the fiber optic connectors and connect the fiber optic cables. The TX port (located on the bottom connector) on the FX/FXE models should be connected to the RX port of the far end station. The RX port (located on the top connector) on the FX/FXE versions should be connected to the TX port of the far end station.

For 10Base-T ports, plug a Category 3 (or greater) twisted pair cable into the RJ45 connector. For 100Base-T ports, plug a Category 5 (or greater) twisted pair cable into the RJ45 connector. Connect the other end to the far end station. Verify that the LNK LED's are ON once the connection has been completed. To connect any other port to another Switch or Repeater, use a standard Cat5 straight through or crossover cable.

Warning: Creating a port to port connection on the same switch (i.e. loop) is an illegal operation and will create a broadcast storm which will crash the network!

TROUBLESHOOTING

1. Make sure the  (Power LED) is ON.
2. Make sure you are supplying sufficient current for the version chosen. Note: The Inrush current will exceed the steady state current by ~ 2X.
3. Verify that Link LED's are ON for connected ports.
4. Verify cabling used between stations.
5. Verify that cabling is Category 3 or greater for 10Mbit Operation.

SUPPORT

Contact N-Tron Corporation at:

TEL: 251-342-2164

FAX: 251-342-6353

WEBSITE: www.redlion.net

E-MAIL: customer.service@redlion.net

FCC STATEMENT

This product complies with Part 15 of the FCC-A Rules.

Operation is subject to the following conditions:

- (1) This device may not cause harmful Interference
- (2) This device must accept any interference received, including interference that may cause undesired operation.

NOTE: This equipment has been tested and found to comply with the limits for a Class A digital device, pursuant to Part 15 of the FCC Rules. These limits are designed to provide reasonable protection against harmful interference in a residential installation. This equipment generates, uses, and can radiate radio frequency energy and, if not installed and used in accordance with the instructions, may cause harmful interference to radio communications. Operation of this device in a residential area is likely to cause harmful interference in which case the user will be required to correct the interference at his/her own expense.

INDUSTRY CANADA

This Class A digital apparatus meets all requirements of the Canadian Interference Causing Equipment Regulations. Operation is subject to the following two conditions; (1) this device may not cause harmful interference, and (2) this device must accept any interference received, including interference that may cause undesired operation.

Cet appareillage numérique de la classe A répond à toutes les exigences de l'interférence canadienne causant des règlements d'équipement. L'opération est sujette aux deux conditions suivantes: (1) ce dispositif peut ne pas causer l'interférence nocive, et (2) ce dispositif doit accepter n'importe quelle interférence reçue, y compris l'interférence qui peut causer l'opération peu désirée.

102MC/MCE - KEY SPECIFICATIONS

Physical

Height:	2.87" (7.28 cm)
Width:	1.49" (3.78 cm)
Depth:	3.53" (8.96 cm)
Weight:	0.5 lbs. (0.22 kg)
DIN Rail	35 mm

Electrical

Input Voltage:	10-30 VDC (Regulated)
Input Current:	140mA max. @ 24VDC (Steady State)
Inrush Current:	8.5 Amp/0.7 ms max. @ 24VDC
Input Ripple:	Less than 100 mV
Input Wire Size:	16-28 AWG

Environmental

Operating Temperature:	-40°C to 80°C
Storage Temperature:	-40°C to 85°C
Operating Humidity:	10% to 95% (Non Condensing)
Operating Altitude:	0 to 10,000 ft.

Network Media

10BaseT:	> Cat-3 Cable
100BaseT:	> Cat-5 Cable
100BaseFX:	Multimode: 50-62.5/125µm Fiber Singlemode: 7-10/125µm Fiber

Fiber Transceiver Characteristics

Fiber Length:	2km*	15km**	40km**	80km**
TX Power Min	-19dBm	-15dBm	-5dBm	-5dBm
RX Sensitivity Max:	-31dBm	-31dBm	-34dBm	-34dBm
Wavelength:	1310nm	1310nm	1310nm	1550nm

*=Multimode **=Singlemode

Connectors

10/100BaseTX:	RJ45 UTP Port
100BaseFX:	SC or ST Duplex Port

Recommended Minimum Wiring Clearance:

Top: 1" (2.54 cm)
Front: 4" (10.16 cm)

Warranty: Effective January 1, 2008, all N-TRON products carry a 3 year warranty from the date of purchase.



Regulatory Approvals:

Safety: Suitable for use in Class I, Division 2, Groups A, B, C and D Hazardous Locations, or Nonhazardous Locations only.

EMI: EN61000-6-4, EN55011 - Class A
FCC Title 47, Part 15, Subpart B - Class A
ICES-003 – Class A

EMS: EN61000-6-2
EN61000-4-2 (ESD)
EN61000-4-3 (RS)
EN61000-4-4 (EFT)
EN61000-4-5 (Surge)
EN61000-4-6 (Conducted Disturbances)

GOST-R Certified

ABS Type Approval for Shipboard Applications

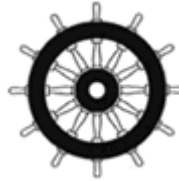

104TX/105TX - KEY SPECIFICATIONS

Physical

<i>Height:</i>	2.87" (7.28 cm)
<i>Width:</i>	1.49" (3.78 cm)
<i>Depth:</i>	3.53" (8.96 cm)
<i>Weight:</i>	0.6 lbs. (0.27 kg)
<i>DIN Rail</i>	35 mm

Electrical

<i>Input Voltage:</i>	10-30 VDC (Regulated)
<i>Input Current:</i>	215 mA max. @ 24VDC (Steady State)
<i>Inrush Current:</i>	7.8 Amp/0.7ms max. @ 24VDC
<i>Input Ripple:</i>	Less than 100 mV
<i>Input Wire Size:</i>	16-28 AWG

Environmental

<i>Operating Temperature:</i>	-40°C to 80°C
<i>Storage Temperature:</i>	-40°C to 85°C
<i>Operating Humidity:</i>	10% to 95% (Non Condensing)
<i>Operating Altitude:</i>	0 to 10,000 ft.

Network Media

<i>10BaseT:</i>	> Cat-3 Cable
<i>100BaseT:</i>	> Cat-5 Cable

Connectors

10/100BaseT: RJ45 UTP Ports

Recommended Minimum Wiring Clearance:

Top: 1 " (2.54 cm)

Front: 2 " (5.08 cm)

Warranty: Effective January 1, 2008, all N-TRON products carry a 3 year warranty from the date of purchase.



Regulatory Approvals:

Safety: Suitable for use in Class I, Division 2, Groups A, B, C and D Hazardous Locations, or Nonhazardous Locations only.

EMI: EN61000-6-4, EN55011 - Class A
FCC Title 47, Part 15, Subpart B - Class A
ICES-003 – Class A

EMS: EN61000-6-2
EN61000-4-2 (ESD)
EN61000-4-3 (RS)
EN61000-4-4 (EFT)
EN61000-4-5 (Surge)
EN61000-4-6 (Conducted Disturbances)

GOST-R Certified

ABS Type Approval for Shipboard Applications



105TX-SL - KEY SPECIFICATIONS

Physical

<i>Height:</i>	4" (10.2 cm)
<i>Width:</i>	1" (2.6 cm)
<i>Depth:</i>	3.7" (9.2 cm)
<i>Weight:</i>	0.7 lbs. (0.32 kg)
<i>DIN Rail</i>	35 mm

Electrical

<i>Input Voltage:</i>	10-30 VDC (Regulated)
<i>Input Current:</i>	215 mA max. @ 24VDC (Steady State)
<i>Inrush Current:</i>	3.0 Amp/1.0 ms max. @ 24VDC
<i>Input Ripple:</i>	Less than 100 mV
<i>Input Wire Size:</i>	12-24 AWG

Environmental

<i>Operating Temperature:</i>	-40°C to 85°C
<i>Storage Temperature:</i>	-40°C to 85°C
<i>Operating Humidity:</i>	10% to 95% (Non Condensing)
<i>Operating Altitude:</i>	0 to 10,000 ft.

Network Media

<i>10BaseT:</i>	≥Cat3 Cable
<i>100BaseT:</i>	≥Cat5 Cable

Connectors

<i>10/100BaseT:</i>	Five (5) RJ45 UTP Ports
---------------------	-------------------------

Recommended Minimum Wiring Clearance:

Top: 1" (2.54 cm)
Front: 2" (5.08 cm)

Warranty: Effective January 1, 2008, all N-TRON products carry a 3 year warranty from the date of purchase.

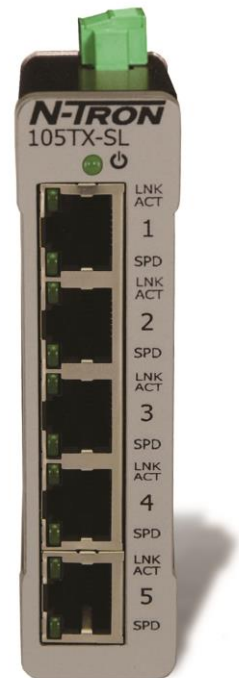

Regulatory Approvals:

Safety: Suitable for use in Class I, Division 2, Groups A, B, C and D Hazardous Locations, or Nonhazardous Locations only.

EMI: ANSI C63.4
FCC Title 47, Part 15, Subpart B - Class A
ICES-003 – Class A

EMC: EN61000-6-4 – Class A (Emissions)
EN55024 (Immunity)
EN61000-4-2 (ESD)
EN61000-4-3 (RS)
EN61000-4-4 (EFT)
EN61000-4-5 (SURGE)
EN61000-4-6 (RF)
EN61000-4-8 (PFMF)
EN61000-4-11 (VDI)

GOST-R Certified
ABS Type Approval for Shipboard Applications



106FX/FX2 - KEY SPECIFICATIONS

Physical

<i>Height:</i>	3.83" (9.73 cm)
<i>Width:</i>	1.50" (3.81 cm)
<i>Depth:</i>	4.80" (12.2 cm)
<i>Weight:</i>	0.6 lbs. (0.27 kg)
<i>DIN Rail</i>	35 mm

Electrical

<i>Input Voltage:</i>	10-30 VDC (Regulated)
<i>Input Current:</i>	270 mA max. @ 24VDC (Steady State)
<i>Inrush Current:</i>	8.0 Amp/0.7 ms max. @ 24VDC

Environmental

<i>Operating Temperature:</i>	-40°C to 70°C
<i>Storage Temperature:</i>	-40°C to 85°C
<i>Operating Humidity:</i>	10% to 95% (Non Condensing)
<i>Operating Altitude:</i>	0 to 10,000 ft.

Network Media

<i>10BaseT:</i>	> Cat-3 Cable
<i>100BaseTX:</i>	> Cat-5 Cable
<i>100BaseFX:</i>	
Multimode:	50-62.5/125µm
Singlemode:	7-10/125µm

Connectors

<i>10/100BaseTX</i>	Four (4) RJ-45 TX Ports
<i>100BaseFX</i>	Two (2) ST or SC Duplex Ports

Recommended Minimum Wiring Clearance:

Top: 1 " (2.54 cm)
Front: 4 " (10.16 cm)

Warranty: Effective January 1, 2008, all N-TRON products carry a 3 year warranty from the date of purchase.



Regulatory Approvals:

Safety: Suitable for use in Class I, Division 2, Groups A, B, C and D Hazardous Locations, or Nonhazardous Locations only.

EMI: IEC61000-6-2, EN55011 - Class A
FCC Title 47, Part 15, Subpart B - Class A
ICES-003 – Class A

EMS: EN61000-6-2
EN61000-4-2 (ESD)
EN61000-4-3 (RS)
EN61000-4-4 (EFT)
EN61000-4-5 (Surge)
EN61000-4-6 (Conducted Disturbances)
EN61000-4-11 (Voltage Dips and Interruptions)

GOST-R Certified
ABS Type Approval for Shipboard Applications



108TX - KEY SPECIFICATIONS

Physical

<i>Height:</i>	3.5" (8.89 cm)
<i>Width:</i>	1.49" (3.78 cm)
<i>Depth:</i>	3.53" (8.96 cm)
<i>Weight:</i>	0.7 lbs. (0.31 kg)
<i>DIN Rail</i>	35 mm

Electrical

<i>Input Voltage:</i>	10-30 VDC (Regulated)
-HV option:	10-60 VDC (Regulated)
<i>Input Current:</i>	250 mA max. @ 24VDC (Steady State)
<i>Inrush Current:</i>	8.1 Amp/0.7 ms max. @ 24VDC
<i>Input Ripple:</i>	Less than 100 mV
<i>Input Wire Size:</i>	16-28 AWG

Environmental

<i>Operating Temperature:</i>	-40°C to 70°C
<i>Storage Temperature:</i>	-40°C to 85°C
<i>Operating Humidity:</i>	10% to 95% (Non Condensing)
<i>Operating Altitude:</i>	0 to 10,000 ft.

Network Media

<i>10BaseT:</i>	> Cat-3 Cable
<i>100BaseT:</i>	> Cat-5 Cable

Connectors

10/100BaseT:	Eight (8) RJ45 UTP Ports
--------------	--------------------------

Recommended Minimum Wiring Clearance:

Top: 1 " (2.54 cm)
Front: 2 " (5.08 cm)

Warranty: Effective January 1, 2008, all N-TRON products carry a 3 year warranty from the date of purchase.

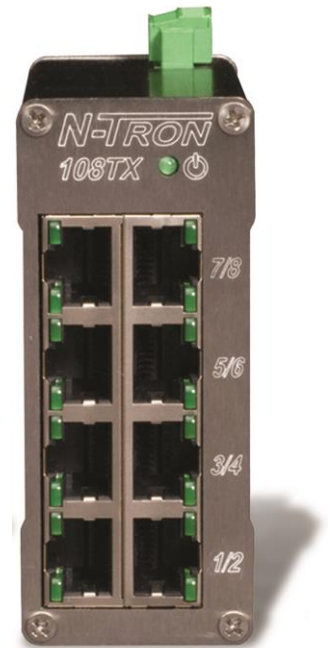

Regulatory Approvals:

Safety: Suitable for use in Class I, Division 2, Groups A, B, C and D Hazardous Locations, or Nonhazardous Locations only.

The high voltage model is TÜV approved GS per EN 60950-1.

EMI: EN61000-6-4, EN55011 - Class A
FCC Title 47, Part 15, Subpart B - Class A
ICES-003 – Class A

EMS: EN61000-6-2
EN61000-4-2 (ESD)
EN61000-4-3 (RS)
EN61000-4-4 (EFT)
EN61000-4-5 (Surge)
EN61000-4-6 (Conducted Disturbances)

GOST-R Certified

ABS Type Approval for Shipboard Applications



HV Model Only

105FX - KEY SPECIFICATIONS

Physical

Height:	3.83" (9.72 cm)
Width:	1.49" (3.78 cm)
Depth:	3.53" (8.96 cm)
Weight:	0.6 lbs. (0.27 kg)
DIN Rail	35 mm

Electrical

Input Voltage:	10-30 VDC (Regulated)
Input Current:	270mA max. @ 24VDC (Steady State)
Inrush Current:	8.0 Amp/0.7 ms max. @ 24VDC
Input Ripple:	Less than 100 mV
Input Wire Size:	16-28 AWG

Environmental

Operating Temperature:	-40°C to 70°C
Storage Temperature:	-40°C to 85°C
Operating Humidity:	10% to 95% (Non Condensing)
Operating Altitude:	0 to 10,000 ft.

Network Media

10BaseT:	> Cat-3 Cable
100BaseT:	> Cat-5 Cable
100BaseFX:	Multimode: 50-62.5/125µm Fiber Singlemode: 7-10/125µm Fiber

Fiber Transceiver Characteristics

Fiber Length:	2km*	15km**	40km**	80km**
TX Power Min	-19dBm	-15dBm	-5dBm	-5dBm
RX Sensitivity Max:	-31dBm	-31dBm	-34dBm	-34dBm
Wavelength:	1310nm	1310nm	1310nm	1550nm

*=Multimode **=Singlemode

Connectors

10/100BaseTX:	RJ45 UTP Port
100BaseFX:	SC or ST Duplex Port

Recommended Minimum Wiring Clearance:

Top: 1 " (2.54 cm)
Front: 4 " (10.16 cm)

Warranty: Effective January 1, 2008, all N-TRON products carry a 3 year warranty from the date of purchase.



Regulatory Approvals:

Safety: Suitable for use in Class I, Division 2, Groups A, B, C and D Hazardous Locations, or Nonhazardous Locations only.

EMI: EN 61000-6-4, EN 55011 - Class A
FCC Title 47, Part 15, Subpart B - Class A
ICES-003 – Class A

EMS: EN 61000-6-2
IEC 61000-4-2 (ESD)
IEC 61000-4-3 (RS)
IEC 61000-4-4 (EFT)
IEC 61000-4-5 (Surge)
IEC 61000-4-6 (Conducted Disturbances)

GOST-R Certified

ABS Type Approval for Shipboard Applications



110FX2 - KEY SPECIFICATIONS

Physical

<i>Height:</i>	4.3" (10.8 cm)
<i>Width:</i>	2.4" (6.1 cm)
<i>Depth:</i>	4.6" (11.5 cm)
<i>Weight:</i>	1 lbs. 5 oz (0.60 kg)
<i>DIN Rail</i>	35 mm

Electrical

<i>Input Voltage:</i>	10-49 VDC (Regulated)
<i>Input Current:</i>	355 mA max. @ 24VDC (Steady State)

Environmental

<i>Surrounding Air Temperature:</i>	-40°C to 80°C
<i>Storage Temperature:</i>	-40°C to 85°C
<i>Operating Humidity:</i>	10% to 95% (Non Condensing)
<i>Operating Altitude:</i>	0 to 10,000 ft.

Network Media

<i>10BaseT:</i>	> Cat-3 Cable
<i>100BaseTX:</i>	> Cat-5 Cable
<i>100BaseFX:</i>	
Multimode:	50-62.5/125µm
Singlemode:	7-10/125µm

Connectors

<i>10/100BaseTX</i>	Eight (8) RJ-45 TX Ports
<i>100BaseFX</i>	Two (2) ST or SC Duplex Ports

Recommended Minimum Wiring Clearance:

Top: 1 " (2.54 cm)
Front: 4 " (10.16 cm)

Warranty: Effective January 1, 2008, all N-TRON products carry a 3 year warranty from the date of purchase.



Regulatory Approvals:

Safety: Suitable for use in Class I, Division 2, Groups A, B, C and D Hazardous Locations, or Nonhazardous Locations only.

EMI: FCC CFR Title 47, Part 15, Subpart B - Class A
ICES-003 – Class A

EMC: EN61000-6-2/4
EN61000-4-2 (ESD)
EN61000-4-3 (RS)
EN61000-4-4 (EFT)
EN61000-4-5 (Surge)
EN61000-4-6 (RF)
EN61000-4-8 (Magnetic Field)
EN61000-4-11 (Voltage Dips and Interruptions)

GOST-R Certified
ABS Type Approval for Shipboard Applications



111FX3 - KEY SPECIFICATIONS

Physical

Height:	4.3" (10.8 cm)
Width:	2.4" (6.1 cm)
Depth:	4.6" (11.5 cm)
Weight:	1 lbs. 5 oz (0.60 kg)
DIN Rail	35 mm

Electrical

Input Voltage:	10-49 VDC (Regulated)
Input Current:	410 mA max. @ 24VDC (Steady State)

Environmental

Surrounding Air Temperature:	-40°C to 80°C
Storage Temperature:	-40°C to 85°C
Operating Humidity:	10% to 95% (Non Condensing)
Operating Altitude:	0 to 10,000 ft.

Network Media

10BaseT:	> Cat-3 Cable
100BaseTX:	> Cat-5 Cable
100BaseFX:	
Multimode:	50-62.5/125µm
Singlemode:	7-10/125µm

Connectors

10/100BaseTX	Eight (8) RJ-45 TX Ports
100BaseFX	Two (2) ST or SC Duplex Ports

Recommended Minimum Wiring Clearance:

Top: 1 " (2.54 cm)
Front: 4 " (10.16 cm)

Warranty: Effective January 1, 2008, all N-TRON products carry a 3 year warranty from the date of purchase.



Regulatory Approvals:

Safety: Suitable for use in Class I, Division 2, Groups A, B, C and D Hazardous Locations, or Nonhazardous Locations only.

EMI: FCC CFR Title 47, Part 15, Subpart B - Class A
ICES-003 – Class A

EMC: EN61000-6-2/4
EN61000-4-2 (ESD)
EN61000-4-3 (RS)
EN61000-4-4 (EFT)
EN61000-4-5 (Surge)
EN61000-4-6 (RF)
EN61000-4-8 (Magnetic Field)
EN61000-4-11 (Voltage Dips and Interruptions)

GOST-R Certified

ABS Type Approval for Shipboard Applications



112FX4 - KEY SPECIFICATIONS

Physical

Height:	4.3" (10.8 cm)
Width:	3.1" (7.9 cm)
Depth:	4.6" (11.5 cm)
Weight:	1 lbs. 9 oz (0.70 kg)
DIN Rail	35 mm

Electrical

Input Voltage:	10-49 VDC (Regulated)
Input Current:	455 mA max. @ 24VDC (Steady State)

Environmental

Surrounding Air Temperature:	-40°C to 80°C
Storage Temperature:	-40°C to 85°C
Operating Humidity:	10% to 95% (Non Condensing)
Operating Altitude:	0 to 10,000 ft.

Network Media

10BaseT:	> Cat-3 Cable
100BaseTX:	> Cat-5 Cable
100BaseFX:	
Multimode:	50-62.5/125µm
Singlemode:	7-10/125µm

Connectors

10/100BaseTX	Eight (8) RJ-45 TX Ports
100BaseFX	Four (4) ST or SC Duplex Ports

Recommended Minimum Wiring Clearance:

Top: 1 " (2.54 cm)
Front: 4 " (10.16 cm)

Warranty: Effective January 1, 2008, all N-TRON products carry a 3 year warranty from the date of purchase.



Regulatory Approvals:

Safety: Suitable for use in Class I, Division 2, Groups A, B, C and D Hazardous Locations, or Nonhazardous Locations only.

EMI: FCC CFR Title 47, Part 15, Subpart B - Class A
ICES-003 – Class A

EMC: EN61000-6-2/4
EN61000-4-2 (ESD)
EN61000-4-3 (RS)
EN61000-4-4 (EFT)
EN61000-4-5 (Surge)
EN61000-4-6 (RF)
EN61000-4-8 (Magnetic Field)
EN61000-4-11 (Voltage Dips and Interruptions)

GOST-R Certified

ABS Type Approval for Shipboard Applications



114FX6 - KEY SPECIFICATIONS

Physical

<i>Height:</i>	4.3" (10.8 cm)
<i>Width:</i>	3.1" (7.9 cm)
<i>Depth:</i>	4.6" (11.5 cm)
<i>Weight:</i>	1 lbs. 10 oz (0.73 kg)
<i>DIN Rail</i>	35 mm

Electrical

<i>Input Voltage:</i>	10-49 VDC (Regulated)
<i>Input Current:</i>	545 mA max. @ 24VDC (Steady State)

Environmental

<i>Surrounding Air Temperature:</i>	-40°C to 80°C
<i>Storage Temperature:</i>	-40°C to 85°C
<i>Operating Humidity:</i>	10% to 95% (Non Condensing)
<i>Operating Altitude:</i>	0 to 10,000 ft.

Network Media

<i>10BaseT:</i>	> Cat-3 Cable
<i>100BaseTX:</i>	> Cat-5 Cable
<i>100BaseFX:</i>	
Multimode:	50-62.5/125µm
Singlemode:	7-10/125µm

Connectors

<i>10/100BaseTX</i>	Eight (8) RJ-45 TX Ports
<i>100BaseFX</i>	Four (4) ST or SC Duplex Ports

Recommended Minimum Wiring Clearance:

Top: 1 " (2.54 cm)
Front: 4 " (10.16 cm)

Warranty: Effective January 1, 2008, all N-TRON products carry a 3 year warranty from the date of purchase.



Regulatory Approvals:

Safety: Suitable for use in Class I, Division 2, Groups A, B, C and D Hazardous Locations, or Nonhazardous Locations only.

EMI: FCC CFR Title 47, Part 15, Subpart B - Class A
ICES-003 – Class A

EMC: EN61000-6-2/4
EN61000-4-2 (ESD)
EN61000-4-3 (RS)
EN61000-4-4 (EFT)
EN61000-4-5 (Surge)
EN61000-4-6 (RF)
EN61000-4-8 (Magnetic Field)
EN61000-4-11 (Voltage Dips and Interruptions)

GOST-R Certified

ABS Type Approval for Shipboard Applications



116TX - KEY SPECIFICATIONS

Physical

<i>Height:</i>	5.8" (14.6 cm)
<i>Width:</i>	2.0" (5.1 cm)
<i>Depth:</i>	4.1" (10.3 cm)
<i>Weight:</i>	1 lb. 1 oz (.48 kg)
<i>DIN Rail</i>	35 mm

Electrical

<i>Input Voltage:</i>	10-49 VDC (Regulated)
<i>Input Current:</i>	300 mA max. @ 24VDC (Steady State)

Environmental

<i>Surrounding Air Temperature:</i>	-40°C to 85°C
<i>Storage Temperature:</i>	-40°C to 85°C
<i>Operating Humidity:</i>	10% to 95% (Non Condensing)
<i>Operating Altitude:</i>	0 to 10,000 ft.

Network Media

<i>10BaseT:</i>	≥Cat3 Cable
<i>100BaseTX:</i>	≥Cat5 Cable

Connectors

<i>10/100BaseTX</i>	Sixteen (16) RJ-45 TX Ports
---------------------	-----------------------------

Recommended Minimum Wiring Clearance:

<i>Top:</i>	1" (2.6 cm)
<i>Front:</i>	2" (5.1 cm)

Warranty: Effective January 1, 2008, all N-TRON products carry a 3 year warranty from the date of purchase.



Regulatory Approvals:

Safety: Suitable for use in Class I, Division 2, Groups A, B, C and D Hazardous Locations, or Nonhazardous Locations only.

EMI: ANSI C63.4
FCC CFR Title 47, Part 15, Subpart B - Class A
ICES-003 – Class A

EMC: EN61000-6-4 – Class A (Emissions)
EN 55024 (Immunity)
EN61000-4-2 (ESD)
EN61000-4-3 (RS)
EN61000-4-4 (EFT)
EN61000-4-5 (Surge)
EN61000-4-6 (RF)
EN61000-4-8 (PFMF)
EN61000-4-11 (VDI)

GOST-R Certified.



N-TRON Limited Warranty

N-TRON, Corporation warrants to the end user that this hardware product will be free from defects in workmanship and materials, under normal use and service, for the applicable warranty period from the date of purchase from N-TRON or its authorized reseller. If a product does not operate as warranted during the applicable warranty period, N-TRON shall, at its option and expense, repair the defective product or part, deliver to customer an equivalent product or part to replace the defective item, or refund to customer the purchase price paid for the defective product. All products that are replaced will become the property of N-TRON. Replacement products may be new or reconditioned. Any replaced or repaired product or part has a ninety (90) day warranty or the remainder of the initial warranty period, whichever is longer. N-TRON shall not be responsible for any custom software or firmware, configuration information, or memory data of customer contained in, stored on, or integrated with any products returned to N-TRON pursuant to any warranty.

OBTAINING WARRANTY SERVICE: Customer must contact N-TRON within the applicable warranty period to obtain warranty service authorization. Dated proof of purchase from N-TRON or its authorized reseller may be required. Products returned to N-TRON must be pre-authorized by N-TRON with a Return Material Authorization (RMA) number marked on the outside of the package, and sent prepaid and packaged appropriately for safe shipment. Responsibility for loss or damage does not transfer to N-TRON until the returned item is received by N-TRON. The repaired or replaced item will be shipped to the customer, at N-TRON's expense, not later than thirty (30) days after N-TRON receives the product. N-TRON shall not be responsible for any software, firmware, information, or memory data of customer contained in, stored on, or integrated with any products returned to N-TRON for repair, whether under warranty or not.

ADVANCE REPLACEMENT OPTION: Upon registration, this product qualifies for advance replacement. A replacement product will be shipped within three (3) days after verification by N-TRON that the product is considered defective. The shipment of advance replacement products is subject to local legal requirements and may not be available in all locations. When an advance replacement is provided and customer fails to return the original product to N-TRON within fifteen (15) days after shipment of the replacement, N-TRON will charge customer for the replacement product, at list price.

WARRANTIES EXCLUSIVE: IF AN N-TRON PRODUCT DOES NOT OPERATE AS WARRANTED ABOVE, CUSTOMER'S SOLE REMEDY FOR BREACH OF THAT WARRANTY SHALL BE REPAIR, REPLACEMENT, OR REFUND OF THE PURCHASE PRICE PAID, AT N-TRON'S OPTION. TO THE FULL EXTENT ALLOWED BY LAW, THE FOREGOING WARRANTIES AND REMEDIES ARE EXCLUSIVE AND ARE IN LIEU OF ALL OTHER WARRANTIES, TERMS, OR CONDITIONS, EXPRESS OR IMPLIED, EITHER IN FACT OR BY OPERATION OF LAW, STATUTORY OR OTHERWISE, INCLUDING WARRANTIES, TERMS, OR CONDITIONS OF MERCHANTABILITY, FITNESS FOR A PARTICULAR PURPOSE, SATISFACTORY QUALITY, CORRESPONDENCE WITH DESCRIPTION, AND NON-INFRINGEMENT, ALL OF WHICH ARE EXPRESSLY DISCLAIMED. N-TRON NEITHER ASSUMES NOR AUTHORIZES ANY OTHER PERSON TO ASSUME FOR IT ANY OTHER LIABILITY IN CONNECTION WITH THE SALE, INSTALLATION, MAINTENANCE OR USE OF ITS PRODUCTS. N-TRON SHALL NOT BE LIABLE UNDER THIS WARRANTY IF ITS TESTING AND EXAMINATION DISCLOSE THAT THE ALLEGED DEFECT OR MALFUNCTION IN THE PRODUCT DOES NOT EXIST OR WAS CAUSED BY CUSTOMER'S OR ANY THIRD PERSON'S MISUSE, NEGLIGENCE, IMPROPER INSTALLATION OR TESTING, UNAUTHORIZED ATTEMPTS TO OPEN, REPAIR OR MODIFY THE PRODUCT, OR ANY OTHER CAUSE BEYOND THE RANGE OF THE INTENDED USE, OR BY ACCIDENT, FIRE, LIGHTNING, POWER CUTS OR OUTAGES, OTHER HAZARDS, OR ACTS OF GOD.

LIMITATION OF LIABILITY: TO THE FULL EXTENT ALLOWED BY LAW, N-TRON ALSO EXCLUDES FOR ITSELF AND ITS SUPPLIERS ANY LIABILITY, WHETHER BASED IN CONTRACT OR TORT (INCLUDING NEGLIGENCE), FOR INCIDENTAL, CONSEQUENTIAL, INDIRECT, SPECIAL, OR PUNITIVE DAMAGES OF ANY KIND, OR FOR LOSS OF REVENUE OR PROFITS, LOSS OF BUSINESS, LOSS OF INFORMATION OR DATA, OR OTHER FINANCIAL LOSS ARISING OUT OF OR IN CONNECTION WITH THE SALE, INSTALLATION, MAINTENANCE, USE, PERFORMANCE, FAILURE, OR INTERRUPTION OF ITS PRODUCTS, EVEN IF N-TRON OR ITS AUTHORIZED RESELLER HAS BEEN ADVISED OF THE POSSIBILITY OF SUCH DAMAGES, AND LIMITS ITS LIABILITY TO REPAIR, REPLACEMENT, OR REFUND OF THE PURCHASE PRICE PAID, AT N-TRON'S OPTION. THIS DISCLAIMER OF LIABILITY FOR DAMAGES WILL NOT BE AFFECTED IF ANY REMEDY PROVIDED HEREIN SHALL FAIL OF ITS ESSENTIAL PURPOSE.

DISCLAIMER: Some countries, states, or provinces do not allow the exclusion or limitation of implied warranties or the limitation of incidental or consequential damages for certain products supplied to consumers or the limitation of liability for personal injury, so the above limitations and exclusions may be limited in their application to you. When the implied warranties are not allowed to be excluded in their entirety, they will be limited to the duration of the applicable written warranty. This warranty gives you specific legal rights which may vary depending on local law.

GOVERNING LAW: This Limited Warranty shall be governed by the laws of the State of Delaware, U.S.A.