

51939-725--
NOTE 3

D
C
B
A

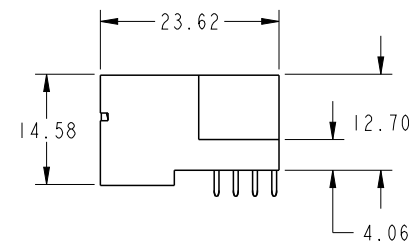
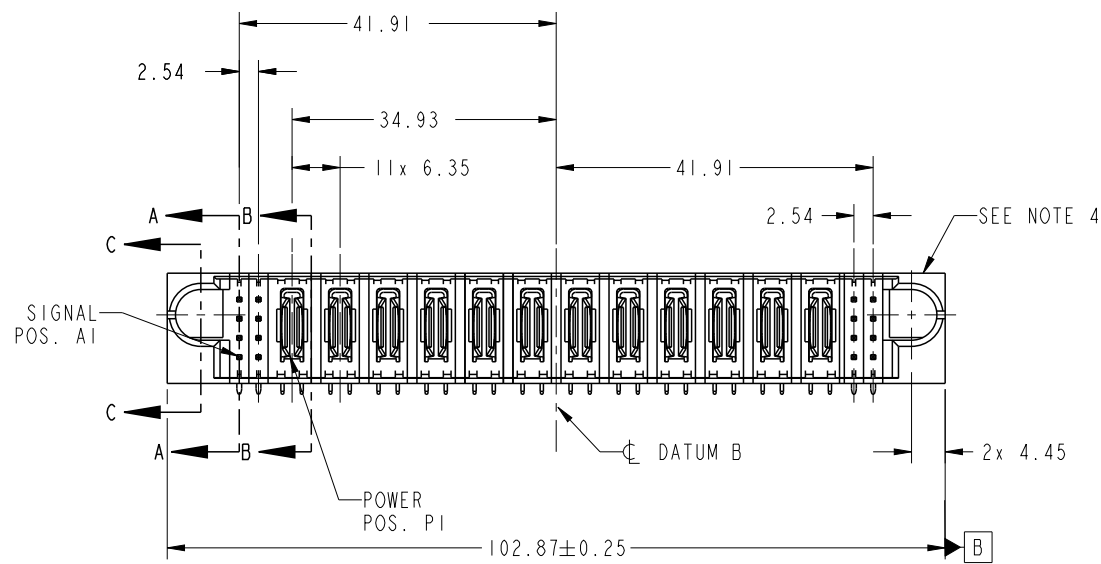

CODE	DIM "M" MATING LENGTH	CONTACT TYPE
U	[6.86]	SIGNAL
T	[6.86]	SIGNAL
S	[6.86]	SIGNAL
R	[6.86]	SIGNAL
E	[5.59]	SIGNAL
H	[5.59]	SIGNAL
PA	[N/A]	POWER

spec ref	*	dr	Luo Weller	2012/12/05	projection	MM	size	A4	scale	1:1
tolerance std	TOLERANCES UNLESS OTHERWISE SPECIFIED	eng	Luo Weller	2014/07/21			ecn no	-		
SEE NOTE		chr	-	-						
surface	✓	appr	Pei-Ming Zheng	2014/07/21	product family	PwrBlade	rel level	Released		
linear		0.X	±0.5		title	8S+12P+8S		dwg no	51939-725	
	0.XX	±0.25	RIGHT ANGLE SOLDER HEADER		rev	A				
angular	0°	±2°	www.fci.com		cat. no.	-	Product - Customer Drw		sheet 1 of 4	

PrdE File - REV C - 2009-06-09



Copyright FCI.

PRODUCT NUMBER

51939-725--
NOTE: 3

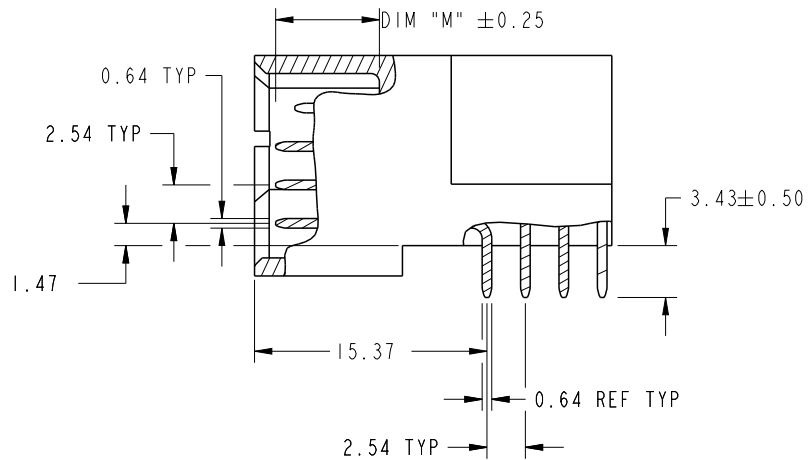

BROKEN-OUT SECTION A-A
SCALE 2:1

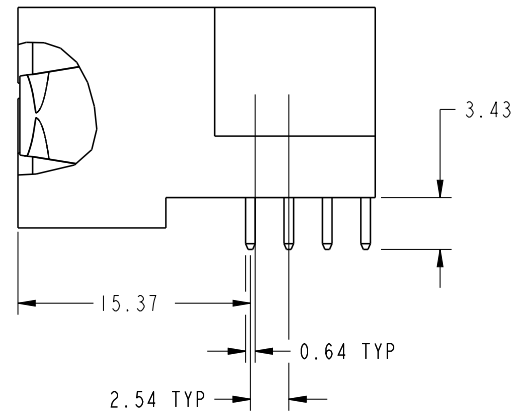

BROKEN-OUT SECTION B-B
SCALE 2:1

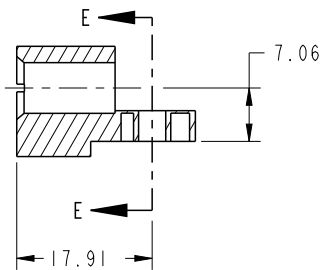

SECTION C-C

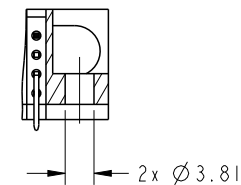

PARTIAL SECTION E-E

dr	Luo Weller	2012/12/05	projection 	MM ←→	size	A4	scale	1:1
eng	Luo Weller	2014/07/21			ecn no	-		
chr	-	-			rel level	Released		
appr	Pei-Ming Zheng	2014/07/21	product family	PwrBlade				
	title	8S+12P+8S		dwg no	51939-725		rev	A
www.fci.com	cat. no.	-	Product - Customer Drw		sheet 2 of 4			

PRODUCT NUMBER

51939-725__
NOTE: 3

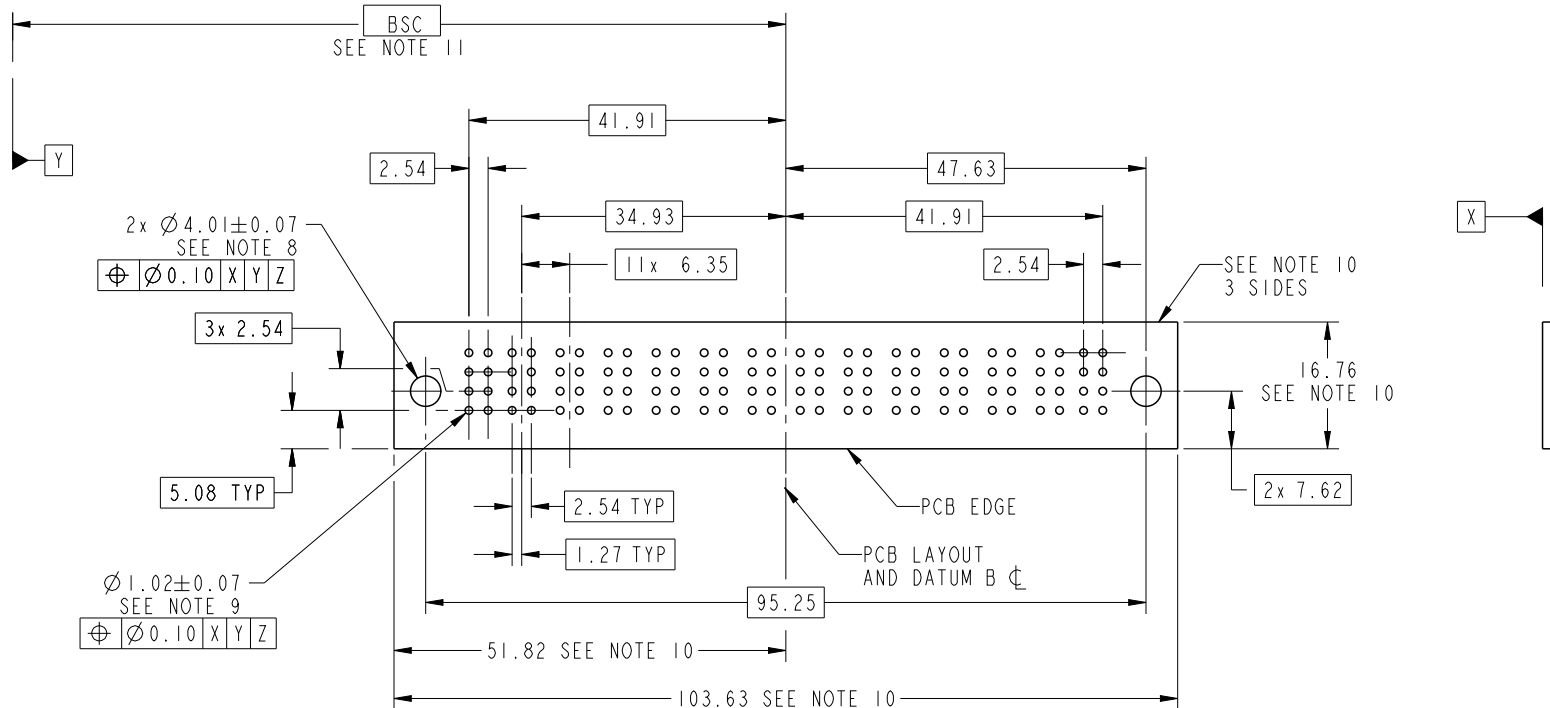

RECOMMENDED PCB LAYOUT



Copyright FCI.

dr	Luo Weller	2012/12/05	projection 	MM 	size	A4	scale	1:1
eng	Luo Weller	2014/07/21			ecn no	-		
chr	-	-			rel level	Released		
appr	Pei-Ming Zheng	2014/07/21	product family	PwrBlade				
	title	8S+12P+8S		dwg no	51939-725		rev	A
www.fci.com	cat. no.	-	Product - Customer Drw		sheet 3 of 4			

PrdrE File - REV C - 2009-06-09

PRODUCT NUMBER

51939-725__
NOTE: 3

NOTES:

1. DIMENSIONS AND TOLERANCES ARE IN ACCORDANCE WITH ASME Y14.5M, 1994 UNLESS OTHERWISE SPECIFIED.

CONNECTOR NOTES:

- 2. HOUSING MATERIAL: UL 94 V-0 GLASS FILLED HIGH-TEMP THERMOPLASTIC
POWER CONTACT MATERIAL: COPPER ALLOY
SIGNAL PIN MATERIAL: COPPER ALLOY
- 3. SEE ITEM 1 & 2 IN PRINT 10064183 FOR PLATING SPEC OF 51939-725 AND 51939-725LF RESPECTIVELY.
- 4. MANUFACTURER'S NAME, DATE CODE AND OPTIONAL P/N TO APPEAR ON THIS SURFACE. THE MARK CAN BE OMITTED IF THERE IS NOT ENOUGH SPACE ON THIS SURFACE.
- 5. PRODUCT SPECIFICATION GS-12-149.
APPLICATION SPECIFICATION BUS-20-067.
- 6. PACKAGED IN TRAYS.

PCB NOTES:

- 7. ALL HOLE DIAMETERS ARE FINISHED HOLE SIZE.
- 8. MOUNTING HOLES, WHERE APPLICABLE, ARE UNPLATED.
- 9. $\varnothing 1.151 \pm 0.025$ DRILLED HOLES PLATED WITH 0.008 MIN SnPb OR Sn OVER 0.03 TO 0.08 Cu PLATING TO ACHIEVE $\varnothing 1.02 \pm 0.07$ HOLE.
- 10. CONNECTOR KEEP-OUT ZONE.
- 11. DATUM AND BASIC DIMENSIONS ARE ESTABLISHED BY CUSTOMER.

dr	Luo Weller	2012/12/05	projection 	MM 	size	A4	scale	1:1		
eng	Luo Weller	2014/07/21			ecn no	-				
chr	-	-			product family	PwrBlade	rel level	Released		
appr	Pei-Ming Zheng	2014/07/21			title	8S+12P+8S	dwg no	51939-725	rev	A
www.fci.com		cat. no.	-	Product - Customer Drw			sheet 4 of 4			