

Apr.1.2017 Copyright 2017 HIROSE ELECTRIC CO., LTD. All Rights Reserved.

RECOMMENDED PC BOARD HOLE PATTERN

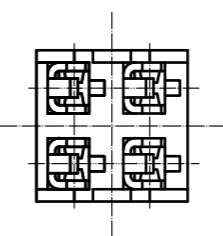
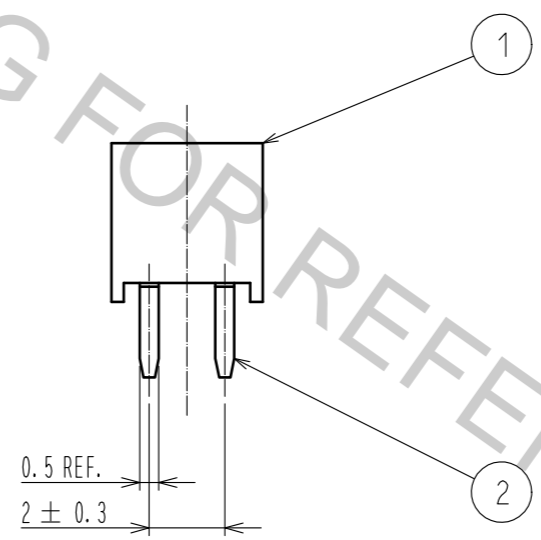
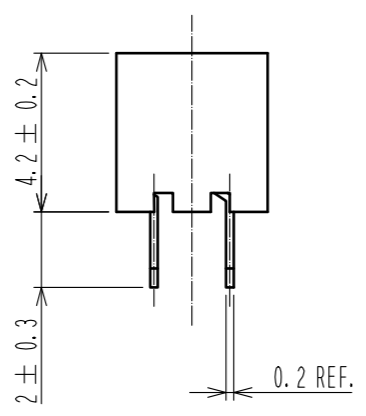
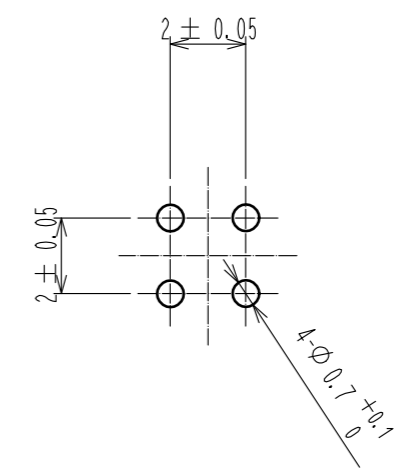
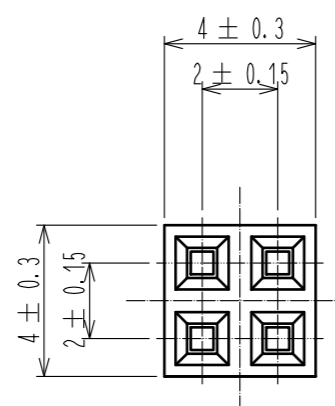

NOTES 1. THE CONTACT CUT SECTION IS UNPLATED.

1	PBT	BLACK. UL94V-0	2	PHOSPHOR BRONZE	CONTACT: GOLD PLATING 0.2µm MIN DIP : TIN PLATING 1µm MIN UNDER :NICKEL PLATING 1µm MIN
NO.	MATERIAL	FINISH . REMARKS	NO.	MATERIAL	FINISH . REMARKS
UNITS		SCALE	COUNT	DESCRIPTION OF REVISIONS	
mm		5:1		DESIGNED	CHECKED
<b>HRS</b> HIROSE ELECTRIC CO., LTD.		APPROVED : HS. OKAWA	15.06.04	DRAWING NO. EDC-081239-71-21	
		CHECKED : HT. YAMAGUCHI	15.06.04	PART NO. A3C-4DA-2DSC(71)	
		DESIGNED : MT. ITANO	15.06.04	CODE NO. CL621-0531-7-71	
		DRAWN : MT. ITANO	15.06.04		