



Technical Data Sheet

3.0mm Multi-Color Round Type LED Lamps

209-3SURSYGC/S530-A6

Features :

- Two chips are matched for uniform light output, wide viewing angle
- Long life-solid state reliability
- I.C. compatible/Low power consumption
- Pb free



Descriptions :

- The 209-3 LED lamps contain two integral chips and is available as both bicolor and bipolar types.
- Hyper Red and Super Yellow Green light is emitted by diodes of AlGaInP and AlGaInP
- Type of bicolor lamps are both white diffused and color diffused while the bicolor are water clear.

Applications :

- TV set
- Monitor
- Telephone
- Computer

PART NO.	Chip		Lens Color
	Material	Emitted Color	
209-3SURSYGC/S530-A6	AlGaInP	Hyper Red	Water Clear
	AlGaInP	Super Yellow Green	

Technical Data Sheet

3.0mm Multi-Color Round Type LED Lamps

209-3SURSYGC/S530-A6

Package Dimensions

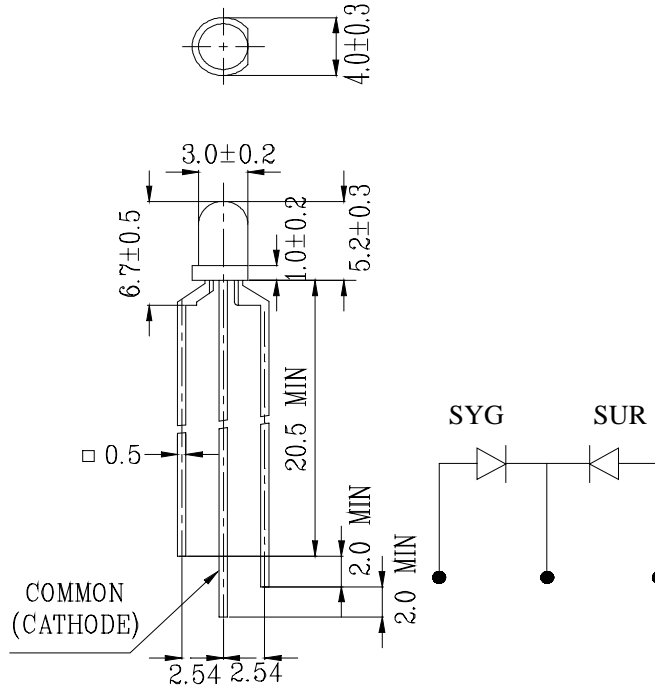

- Notes:**
1. All dimensions are in millimetres
 2. An epoxy meniscus may extend about 1.5mm(0.059") down to the lead.
 3. Tolerances unless Dimension ± 0.25 mm.

Absolute Maximum Ratings at $T_a = 25^\circ\text{C}$

Parameter	Symbol	Rating		Unit
		SUR/S530	SYG/S530	
Forward Current	I _F	25	25	mA
Operating Temperature	T _{opr}	-40 to +85		°C
Storage Temperature	T _{stg}	-40 to +100		°C
Soldering Temperature	T _{sol}	260 ± 5		°C
Electrostatic Discharge	ESD	2000	2000	V
Power Dissipation	P _d	60	60	mW
Reverse Voltage	V _R	5		V

Note: *1: Soldering time \leq 5 seconds.



Technical Data Sheet

3.0mm Multi-Color Round Type LED Lamps

209-3SURSYGC/S530-A6

Electro-Optical Characteristics (Ta=25°C)

Parameter	Symbol	Min.	Typ.	Max.	Unit	Condition
Luminous Intensity	I _v SUR/S530	400	630	/	mcd	I _F = 20 mA
	SYG/S530	200	320	/		
Viewing Angle	2θ 1/2	/	20	/	deg	I _F = 20 mA
Peak Wavelength	λ _p SUR/S530	/	632	/	nm	I _F = 20 mA
	SYG/S530	/	575	/		
Dominant Wavelength	λ _d SUR/S530	/	624	/	nm	I _F = 20 mA
	SYG/S530	/	573	/		
Spectrum Radiation Bandwidth	Δλ SUR/S530	/	20	/	nm	I _F = 20 mA
	SYG/S530	/	20	/		
Forward Voltage	V _F SUR/S530	/	2.0	2.4	V	I _F = 20 mA
	SYG/S530	/	2.0	2.4		
Reverse Current	I _R SUR/S530	/	/	10	μA	V _R = 5 V
Reverse Current	SYG/S530	/	/	10	μA	V _R = 5 V



Technical Data Sheet

3.0mm Multi-Color Round Type LED Lamps

209-3SURYGC/S530-A6

Typical Electro-Optical Characteristic Curves:

(SUR)

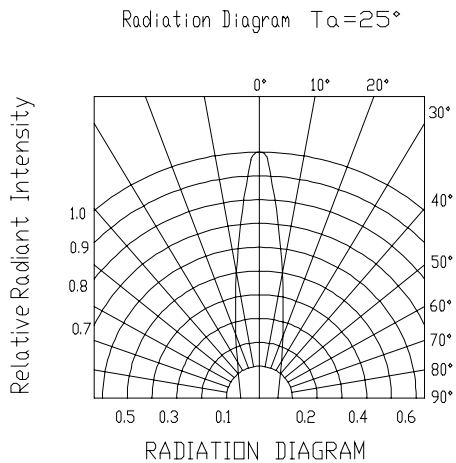
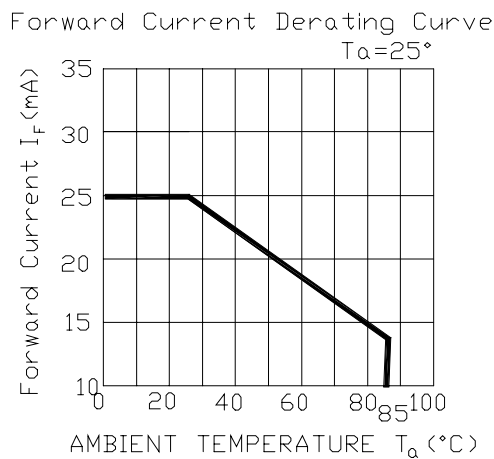
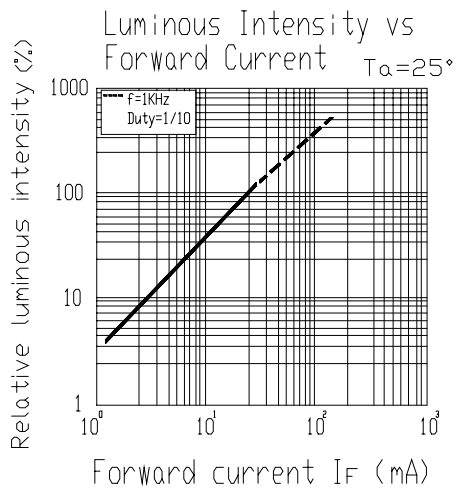
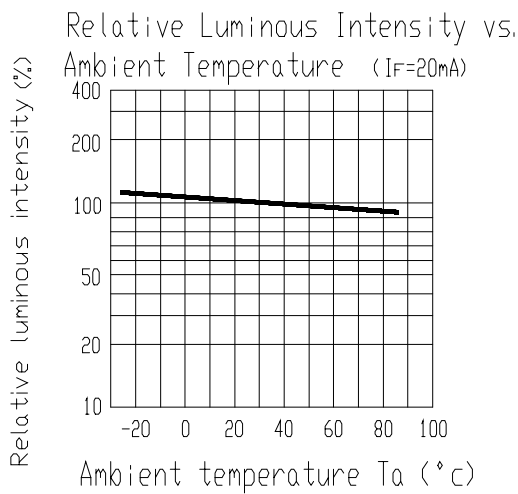
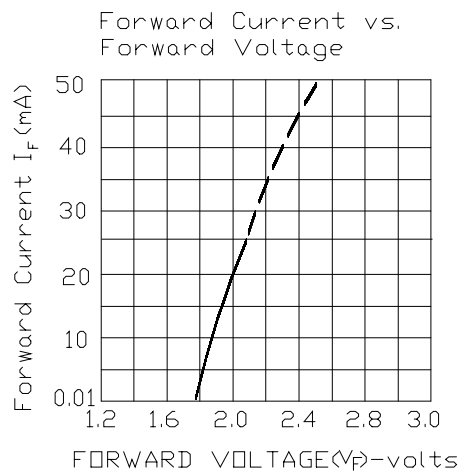
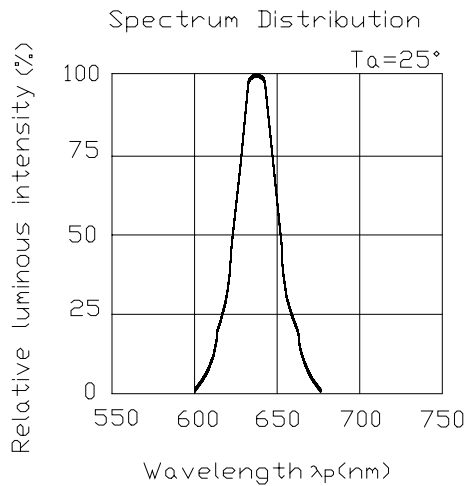



Technical Data Sheet

3.0mm Multi-Color Round Type LED Lamps

209-3SURSYGC/S530-A6

Typical Electro-Optical Characteristic Curves:

(SYG)

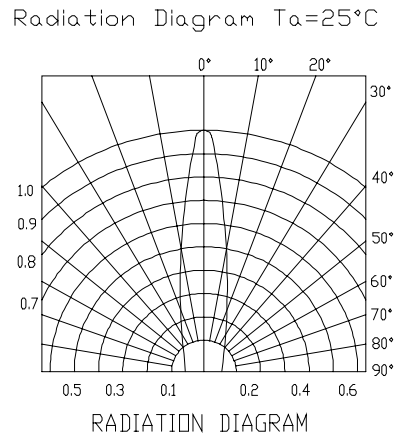
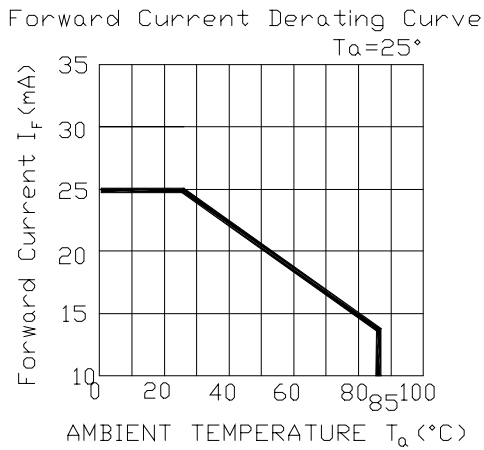
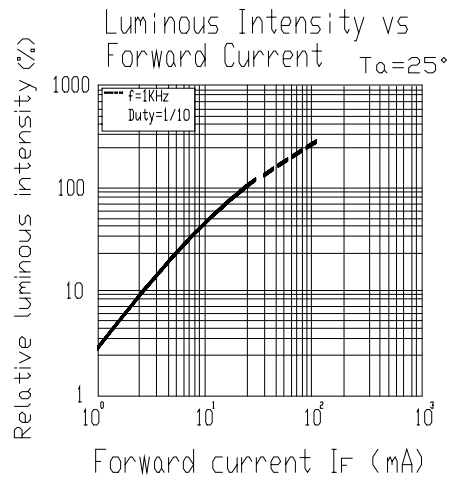
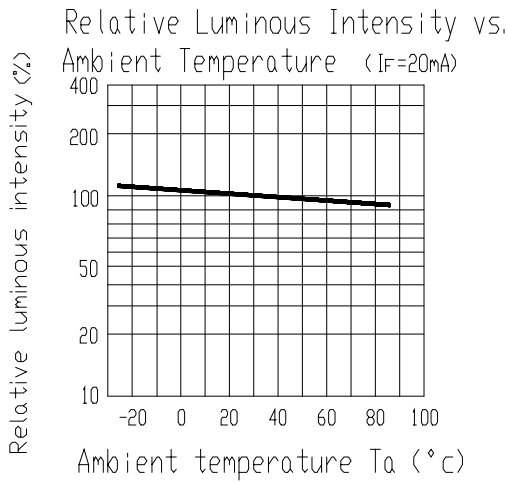
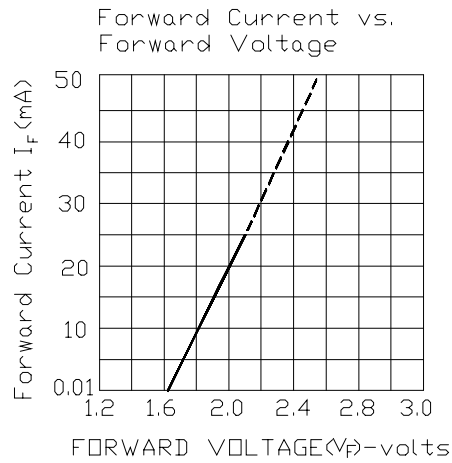
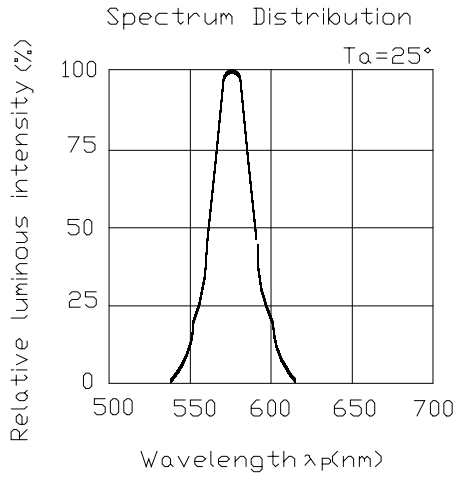



Technical Data Sheet

3.0mm Multi-Color Round Type LED Lamps

209-3SURSYGC/S530-A6

■ Reliability test items and conditions:

The reliability of products shall be satisfied with items listed below.

Confidence level : 97%

LTPD : 3%

NO	Item	Test Conditions	Test Hours/Cycle	Sample Size	Failure Judgment Criteria	Ac/Re
1	Solder Heat	TEMP : 260°C ± 5 °C	10 SEC	76 PCS	Iv ≤ Ivt*0.5 or Vf ≥ U or Vf ≤ L	0/1
2	Temperature Cycle	H : +100°C 15min ∫ 5 min L : -40°C 15min	300 CYCLES	76 PCS		0/1
3	Thermal Shock	H : +100°C 5min ∫ 10 sec L : -10°C 5min	300 CYCLES	76 PCS		0/1
4	High Temperature Storage	TEMP : 100°C	1000 HRS	76 PCS		0/1
5	Low Temperature Storage	TEMP : -40°C	1000 HRS	76 PCS		0/1
6	DC Operating Life	TEMP : 25°C I _F = 20mA	1000 HRS	76 PCS		0/1
7	High Temperature / High Humidity	85°C / 85% RH	1000 HRS	76 PCS		0/1

Note : Ivt : To test Iv value of the chip before the reliability test
Iv : The test value of the chip that has completed the reliability test
U : Upper Specification Limit
L : Lower Specification Limit



Technical Data Sheet

3.0mm Multi-Color Round Type LED Lamps

209-3SURSYGC/S530-A6

Packing Quantity Specification

1.500PCS/1Bag , 4Bags/1Box

2.10Boxes/1Carton

Label Form Specification

EVERLIGHT

CPN:

P/N:



209-3SURSYGC/S530-A6

QTY:



CAT:

HUE:

REF:

LOT NO: EL



MADE IN TAIWAN

CPN: Customer's Production Number

P/N : Production Number

QTY: Packing Quantity

CAT: Ranks

HUE: Dominant Wavelength

REF: Reference

LOT No: Lot Number

MADE IN TAIWAN: Production Place

Notes

1. Above specification may be changed without notice. EVERLIGHT will reserve authority on material change for above specification.
2. When using this product, please observe the absolute maximum ratings and the instructions for using outlined in these specification sheets. EVERLIGHT assumes no responsibility for any damage resulting from use of the product which does not comply with the absolute maximum ratings and the instructions included in these specification sheets.
3. These specification sheets include materials protected under copyright of EVERLIGHT corporation. Please don't reproduce or cause anyone to reproduce them without EVERLIGHT's consent.

EVERLIGHT ELECTRONICS CO., LTD.

Office: No 25, Lane 76, Sec 3, Chung Yang Rd,

Tucheng Tainei 236 Taiwan R.O.C.

Tel: 886-2-2267-2000, 2267-9936

Fax: 886-2267-6244, 2267-6189, 2267-6306

http://www.everlight.com