

THIS DRAWING IS UNPUBLISHED
 RELEASED FOR PUBLICATION
 - .2017.
 © COPYRIGHT - 2017 by TE Connectivity Germany GmbH
 ALL RIGHTS RESERVED.

REVISIONS				
P	LTR	DESCRIPTION	DATE	APVD
	A1	New Release	09MAR2017	GCM/MSZ

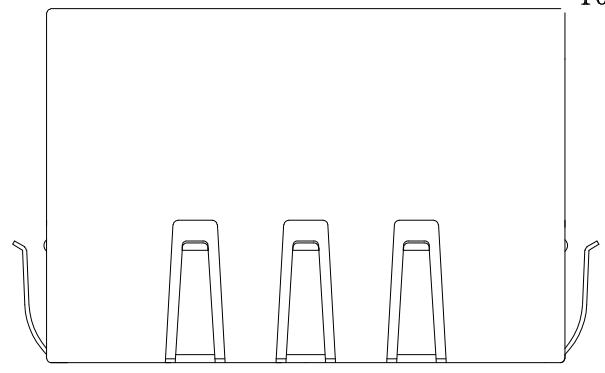

- △ CONNECTOR MATERIAL:
 HOUSING: LCP BLACK UL94 V-0
 INSERT: LCP BLACK UL94 V-0
 SHIELD: BRASS
 SHIELD PLATING: NICKEL
 CONTACT: COPPER ALLOY
 CONTACT PLATING: SELECTIVE GOLD, MIN. 0.76µm (30µinch) IN CONTACT AREA
 OVER MIN. 1.27µm (50µinch) NICKEL
 SOLDER PIN PLATING: 3.05µm (120µinch) TIN OVER 1.02µm (40µinch) NICKEL
 OVER ALL
 SHIELDING PIN PLATING: NICKEL
- 2 PIN NOT ELECTRICALLY CONNECTED MAYBE OMITTED SEE ELECTRICAL CIRCUIT DIAGRAM FOR OMITTED PINS
- 3 RJ45 CAVITIES CONFORM TO FCC RULES AND REGULATION PART 68
- 4 THE PART IS RECOMMENDED FOR REFLOW SOLDERING PROCESS PEAK SOLDERING: TEMPERATURE MAX. +260° C, MAX. 10s
- 5 OPERATING TEMPERATURE: T= -40° C TO +85° C
- 6 STORAGE TEMPERATURE: T= -40° C TO +85° C
- △ UNLESS OTHERWISE SPECIFIED, SEE TABLE FOR ALL DIMENSIONS TOLERANCES
- 8 JACK CONFIGURATION: 1 x 2
 TAB DIRECTION: DOWN
- 9 PACKAGING: REEL (T+R) ACCORDING TO PACKAGING SPECIFICATION 107-18116

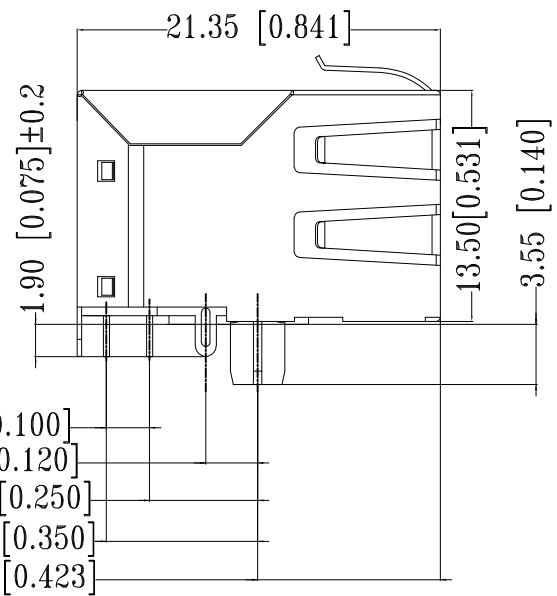
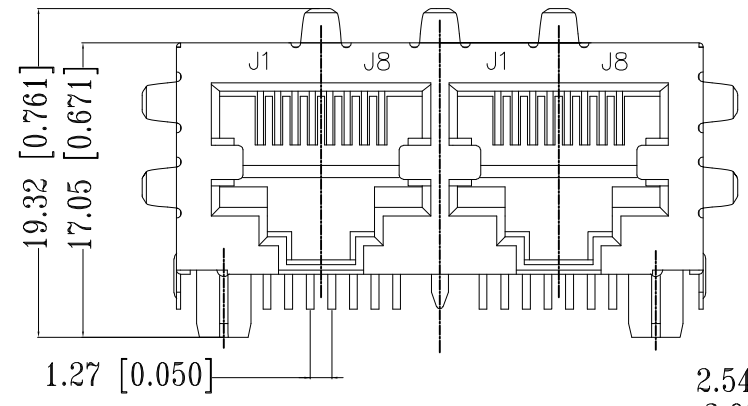
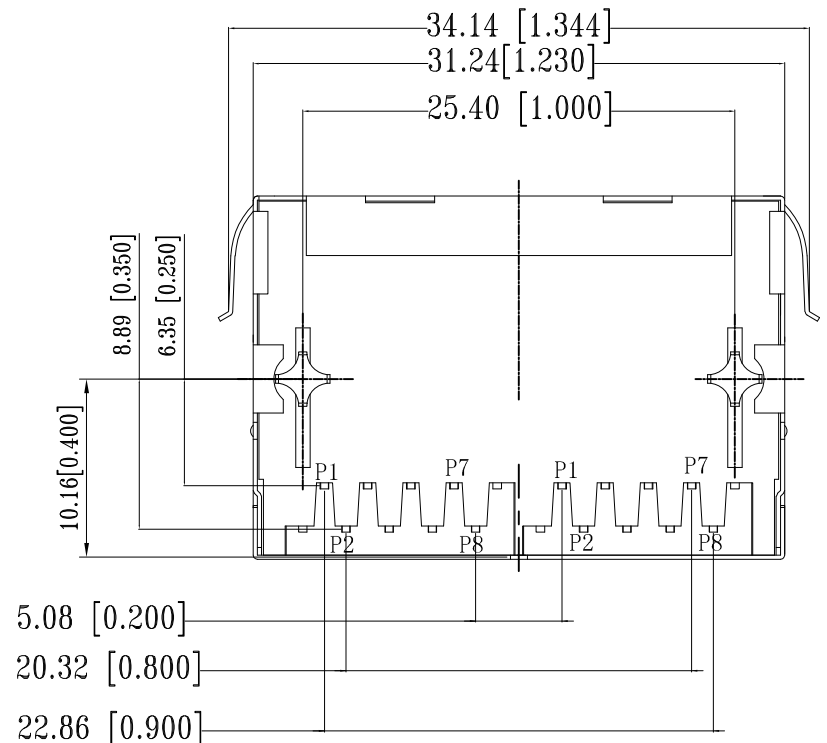
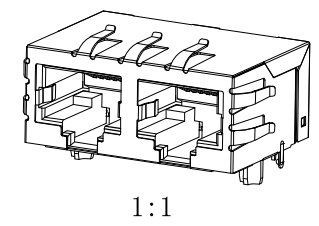

TABLE OF TOLERANCE (mm)	
RANGE	TOLERANCE
0-10	±0.15
>10-40	±0.25
>40-70	±0.30
>70	±0.40

THIS DRAWING IS A CONTROLLED DOCUMENT.		DWN GANESH C M 27AUG2016	STE TE Connectivity	
DIMENSIONS: mm [INCHES]		CHK FRANZ MUELLER 27AUG2016		
TOLERANCES UNLESS OTHERWISE SPECIFIED:		APVD MARTIN SZELAG 27AUG2016	NAME RJ45 JACK INT.MAG. 10/100 1x2	
0 PLC ± -		PRODUCT SPEC 108-94552	-	
1 PLC ± -		APPLICATION SPEC 114-94447	-	
2 PLC ± -		WEIGHT -	SIZE A3	CAGE CODE 00779
3 PLC ± -		CUSTOMER DRAWING	DRAWING NO	RESTRICTED TO
4 PLC ± -			G-2301996-2	-
ANGLES ± -		SCALE 3:1		
FINISH		SHEET 1 OF 3		
△ 1		REV A1		



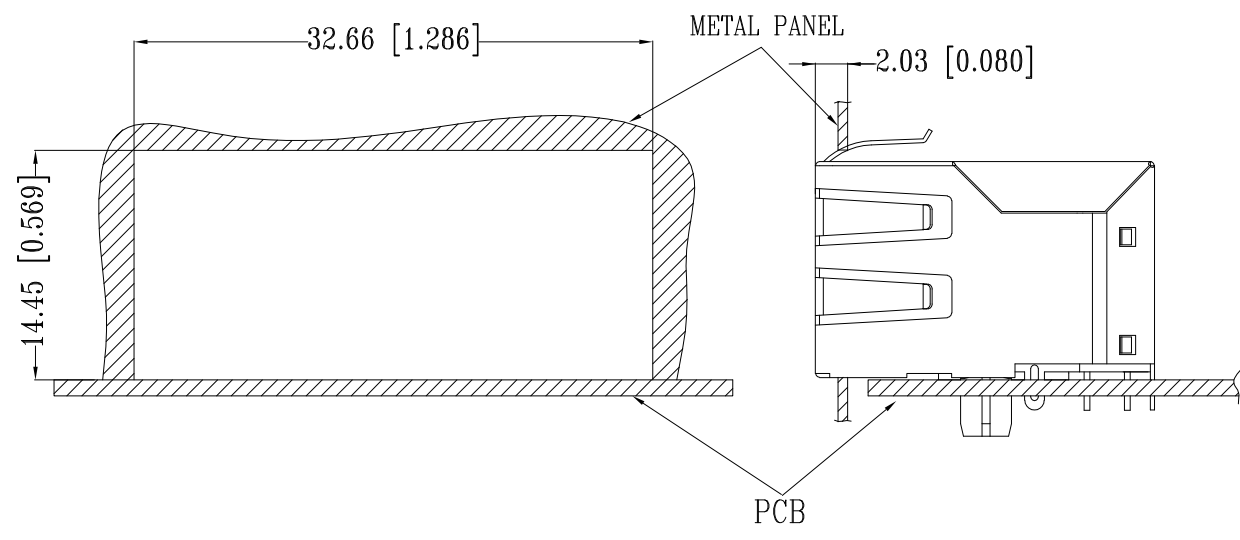
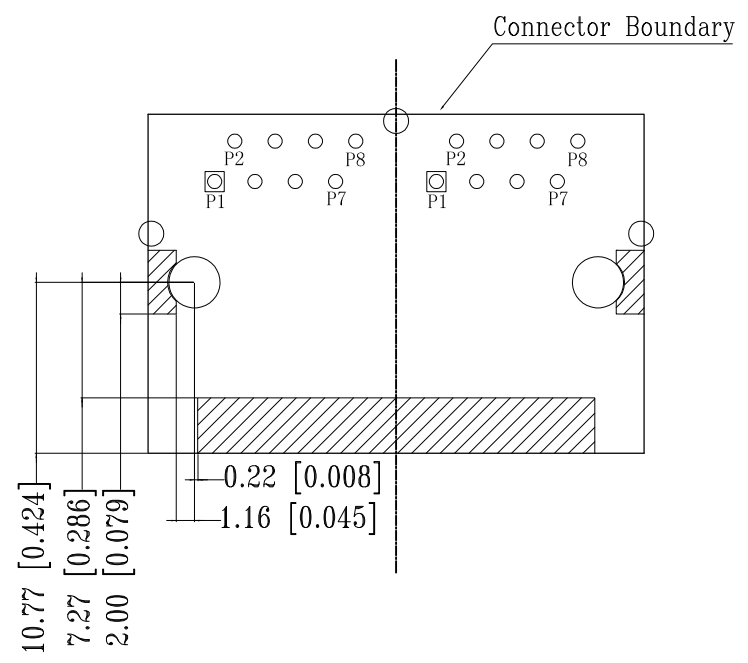
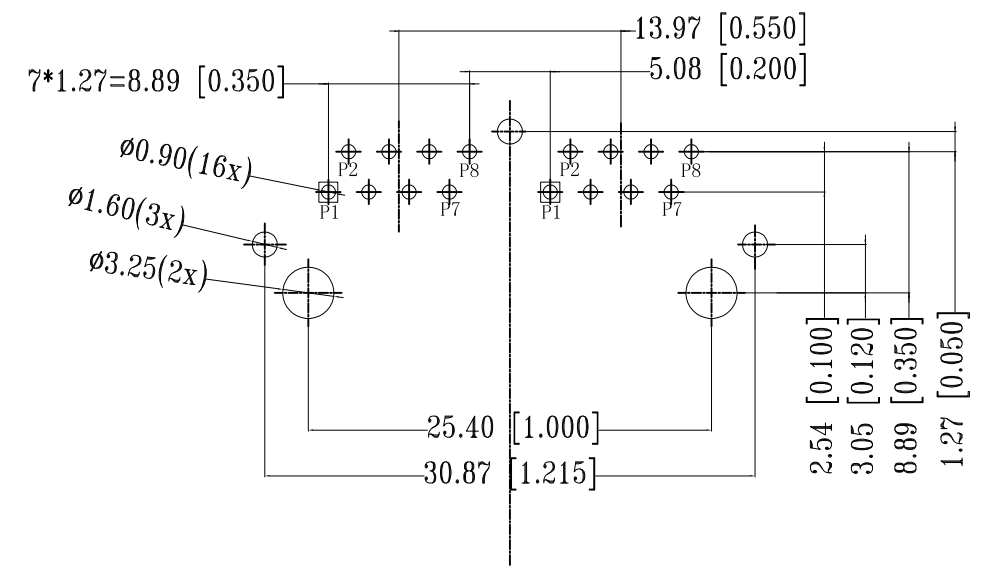

THIS DRAWING IS UNPUBLISHED
 RELEASED FOR PUBLICATION - , 2017.
 © COPYRIGHT - 2017 by TE Connectivity Germany GmbH ALL RIGHTS RESERVED.

REVISIONS					
P	LTR	DESCRIPTION	DATE	DWN	APVD
-	-	SEE SHEET 1	-	-	-

SUGGESTED PCB LAYOUT



UNIT: mm / inch
 TOLERANCES: ±0.10 / 0.004

THIS DRAWING IS A CONTROLLED DOCUMENT.		DWN GANESH C M 27AUG2016	 TE Connectivity		
DIMENSIONS: mm [INCHES]		CHK FRANZ MUELLER 27AUG2016			
TOLERANCES UNLESS OTHERWISE SPECIFIED:		APVD MARTIN SZELAG 27AUG2016	NAME RJ45 JACK INT.MAG. 10/100 1x2		
0 PLC ± - 1 PLC ± - 2 PLC ± - 3 PLC ± - 4 PLC ± - ANGLES ± -		PRODUCT SPEC 108-94552	RESTRICTED TO		
		APPLICATION SPEC 114-94447	SIZE A3	CAGE CODE 00779	DRAWING NO C-2301996-2
MATERIAL 		WEIGHT 0	SCALE 3:1		
FINISH 		CUSTOMER DRAWING		SHEET 2 OF 3	REV A1

REVISIONS

P	LTR	DESCRIPTION	DATE	DWN	APVD
-	-	SEE SHEET 1	-	-	-

ELECTRICAL CIRCUIT DIAGRAM

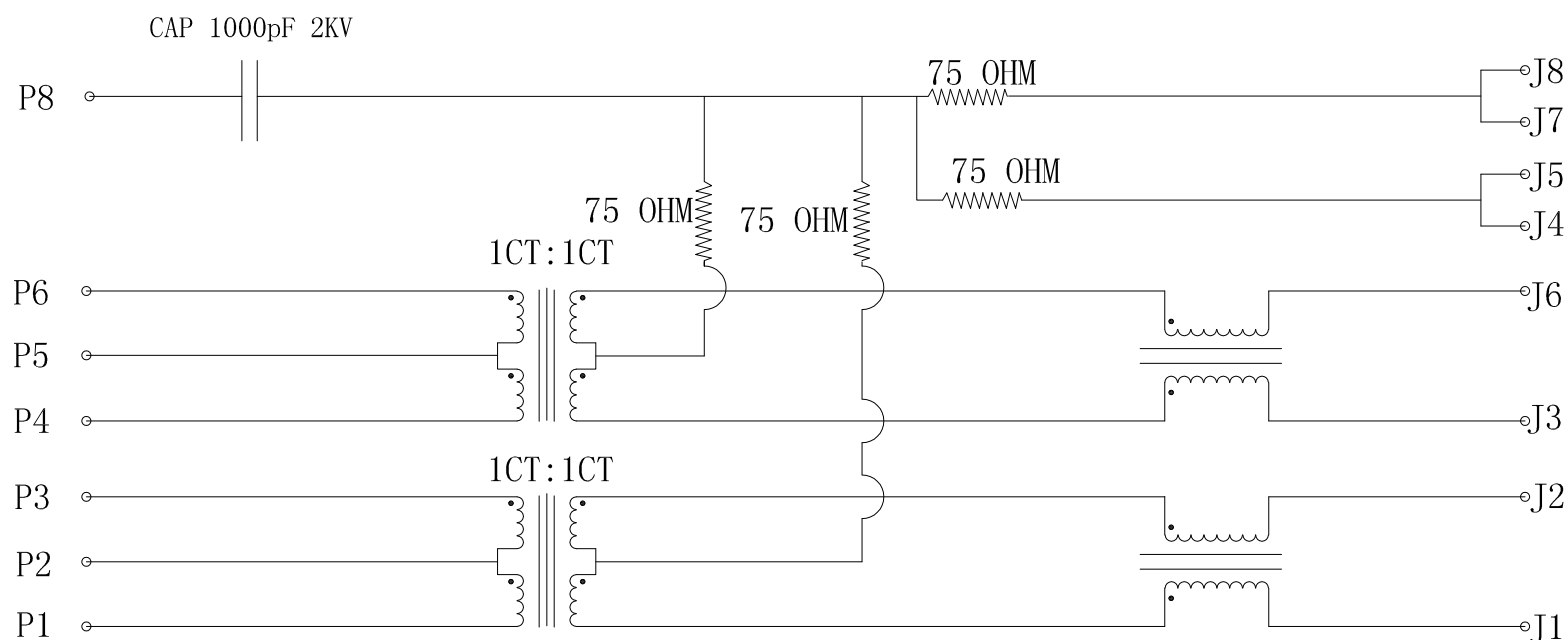

- 1.0 Turn Ratio @100KHz: (P1~P3):(J1~J2) = 1:1±2%
(P4~P6):(J3~J6) = 1:1±2%
- 2.0 Primary Inductance: 350uH MIN @100KHZ,0.1V 8mA DC BIAS
- 3.0 DC Resistance: 1.2 OHMS MAX
- 4.0 Insertion Loss: 1-100MHz -1.2dB MAX
- 5.0 Return Loss: 1-30MHz -16dB MIN
30-60MHz -12dB MIN
60-80MHz -10dB MIN
- 6.0 CROSS TALK: 1-100MHz -30dB MIN
- 7.0 COMMON TO COMMON MODE ATTENUATION: 1-100MHz -30dB MIN
- 8.0 Isolation: PHY Side to Line Side: 2250VDC

2301996-2
WWYY-xxxx

TE

FCC

CONTROL CODE
DATE CODE
"0213"
YY-YEAR
WW-WEEK

THIS DRAWING IS A CONTROLLED DOCUMENT.		DWN GANESH C M 27AUG2016	TE TE Connectivity		
DIMENSIONS: mm [INCHES]		CHK FRANZ MUELLER 27AUG2016			
TOLERANCES UNLESS OTHERWISE SPECIFIED:		APVD MARTIN SZELAG 27AUG2016	NAME RJ45 JACK INT.MAG. 10/100 1x2		
0 PLC ± - 1 PLC ± - 2 PLC ± - 3 PLC ± - 4 PLC ± - ANGLES ± -		PRODUCT SPEC 108-94552	SIZE A3		
MATERIAL 1		FINISH 1	APPLICATION SPEC 114-94447	CAGE CODE 00779	DRAWING NO C-2301996-2
CUSTOMER DRAWING			RESTRICTED TO -	SCALE 3:1	SHEET 3 of 3
			WEIGHT 0	REV A1	