

Evaluating the *iCoupler* **ADuM4070** Isolated Switching Regulator with Integrated Feedback

FEATURES

ADuM4070 circuit, including 5 kV rms isolated dc-to-dc converters

Single supply (default)

5 V input to 5 V output (regulated)

Reconfigurable to 5 V input to 3.3 V output or 3.3 V input to 3.3 V output

Double supply

5 V input to 15 V output (regulated) and 7.5 V output (unregulated)

Reconfigurable to 5 V input to 12 V output (regulated) and 6 V output (unregulated)

Footprints for Coilcraft, Inc., and Halo Electronics, Inc., transformer options

Multiple switching frequency options

SUPPORTED *iCoupler* MODELS

ADuM4070

GENERAL DESCRIPTION

The **EVAL-ADuM4070EBZ** can be used for different applications of the **ADuM4070** isolated switching regulator. With the ability to be configured as a circuit with either single- (default) or double-supply output, the board supports a variety of input/output configurations and multiple transformer options. It is equipped with an **ADuM4070** regulator for voltage isolation; the regulator features integrated feedback and a switching frequency that can be set from 200 kHz to 1000 kHz.

This user guide provides all the necessary details to set up and use the **EVAL-ADuM4070EBZ** board. Additional information about the **ADuM4070** device is available in the **ADuM4070** data sheet, which should be consulted in conjunction with this user guide when using the **EVAL-ADuM4070EBZ** board.

ADuM4070 EVALUATION BOARD PHOTOGRAPH

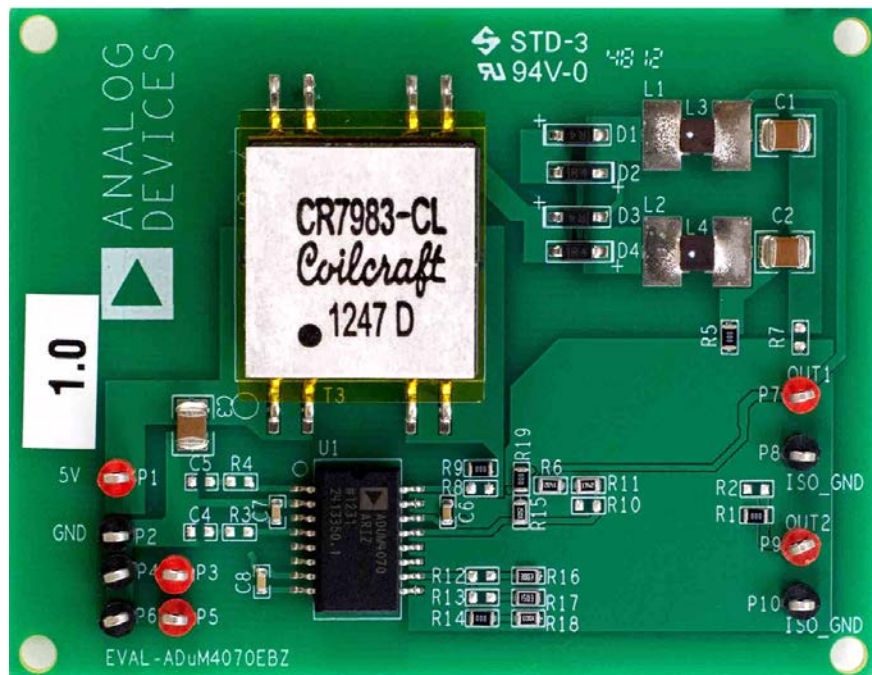

Figure 1. Single-Supply and Double-Supply Configurations

TABLE OF CONTENTS

Features	1	Other Input and Isolated Output Supply Options	5
Supported iCoupler Models	1	Double Supply	7
General Description	1	Terminals	7
ADuM4070 Evaluation Board Photograph.....	1	Transformer Selection	7
Revision History	2	Switching Frequency Options.....	7
Configuring the Board for Single- or Double-Supply Output ...	3	Other Secondary Isolated Supply Configurations	8
Single Supply	4	Evaluation Board Schematic and Artwork.....	9
Terminals	4	Evaluation Board Layout	9
Transformer Selection.....	5	Bill of Materials.....	10
Switching Frequency Options.....	5		

REVISION HISTORY

3/13—Revision 0: Initial Version

CONFIGURING THE BOARD FOR SINGLE- OR DOUBLE-SUPPLY OUTPUT

The [ADuM4070](#) evaluation board can be configured for an isolated circuit with either single- or double-supply output. See Table 1 for information about the setup of the feedback divider resistors for the single- and double-supply configurations. For additional applications information about the [ADuM4070](#) in these configurations, see the [ADuM4070](#) data sheet. Figure 12 shows the schematic for the [EVAL-ADuM4070EBZ](#) board in single- and double-supply configurations.

Table 1. Feedback Divider Resistors Configuration

Configuration	R6	R10	R11	R15
3.3 V Single	17.4 k Ω	0 Ω	14.3 k Ω	10.5 k Ω
5 V Single	17.4 k Ω	Open	14.3 k Ω	10.5 k Ω
12 V Double	90.9 k Ω	0 Ω	24.9 k Ω	10.5 k Ω
15 V Double	90.9 k Ω	Open	24.9 k Ω	10.5 k Ω

The single- or double-supply configuration can be selected by changing the output mode resistor values as described in Table 2.

Table 2. Output Mode Resistors Configuration

Configuration	R5	R7	R8	R9	R19
3.3 V/5 V Single	Open	0 Ω	Open	0 Ω	0 Ω
12V/15V Double	0 Ω	Open	0 Ω	Open	Open
\pm 15 V Double	Open	0 Ω	Open	0 Ω	Open

After setting the feedback divider and output mode resistors, refer to the Single Supply or Double Supply section for additional information about configuring the [EVAL-ADuM4070EBZ](#) board.

SINGLE SUPPLY

The [ADuM4070](#) switching regulator on this evaluation board is configured by default for single-supply output. When the [ADuM4070](#) is set to single-supply mode, the feedback divider resistors should be configured as described in Table 1 and the output mode resistors should be configured as described in Table 2.

By default, the single-supply configuration provides a 5 V secondary isolated supply with a 5 V primary input supply, which can provide up to 2.5 W of regulated, isolated power. The single supply can be reconfigured as a 3.3 V secondary isolated supply with a 5 V or 3.3 V primary input supply. See the Other Input and Isolated Output Supply Options section for more information.

TERMINALS

In the single-supply configuration, the [EVAL-ADuM4070EBZ](#) board has terminal blocks on Side 1 (the primary/power supply input side) and Side 2 (the secondary/power supply output side). An 8.0 mm isolation barrier separates Side 1 from Side 2. Figure 2 shows the location of these terminals.

Table 3 summarizes the functions of the terminal connections. These connections are described in more detail in the Input Power Connections and Output Power Connections sections.

Table 3. Single-Supply Terminal Function Descriptions

Terminal	Label	Description
P1	5V	Side 1—5 V primary input supply
P2	GND	Side 1—ground reference
P7	OUT1	Side 2—5 V secondary isolated supply
P8	ISO_GND	Side 2—ground reference

Input Power Connections

Connect 5 V to P1, labeled 5V (or connect 3.3 V to P1 for a 3.3 V primary input supply with a 3.3 V secondary isolated supply). Connect the negative end of the supply to P2, labeled GND. These are the only off-board connections required for the board to function in single-supply configuration.

V_{DD1} is the [ADuM4070](#) transformer driver supply, and V_{DDA} is the primary supply voltage (see the [ADuM4070](#) data sheet for additional information). V_{DD1} and V_{DDA} are bypassed by a 47 μ F ceramic capacitor (C3) and a 0.1 μ F local bypass capacitor (C8) located close to the [ADuM4070](#). R4, R3, C4, and C5 are provided for an optional and unpopulated snubber, which can be used to reduce radiated emissions.

Power is transferred to Side 2 by a regulated push-pull converter, comprising the [ADuM4070](#) (U1), an external transformer (T2 or T3), and other components (see the [ADuM4070](#) data sheet for an explanation of this circuit functionality).

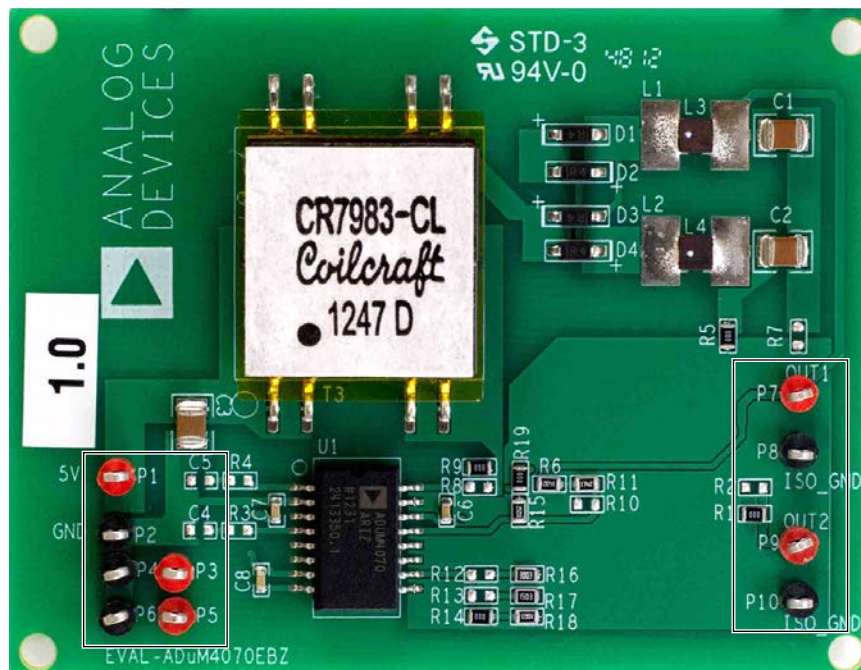

Figure 2. Single-Supply and Double-Supply Board Terminals

Output Power Connections

An output load can be connected to P7, labeled OUT1, which is the isolated, regulated 5 V output supply. Connect the return of the load to P8, labeled ISO_GND, which is the Side 2 ground reference. Including the current necessary for the [ADuM4070](#) secondary side (I/O and pulse-width modulation control), this supply can provide up to 500 mA in the default configuration—a 5 V primary input supply with a 5 V secondary isolated supply. Figure 4 through Figure 7 show how the efficiency of the power supply varies with load current, switching frequency, and temperature.

TRANSFORMER SELECTION

The [EVAL-ADuM4070EBZ](#) supports multiple transformer options. In the single-supply configuration, the board is equipped with a Halo Electronics TGRAD-560V8LF (T2) or a Coilcraft CR7983-CL (T3) 1CT:2CT turns ratio transformer; the default is the Coilcraft transformer. The Halo Electronics footprint is in the middle of the Coilcraft footprint. Figure 4 and Figure 6 show the efficiency curves when the board operates in single-supply configuration using a Coilcraft transformer (CR7983-CL) and a Halo Electronics (TGRAD-560V8LF) transformer, respectively.

SWITCHING FREQUENCY OPTIONS

The resistance connected from the [ADuM4070](#) oscillator control pin (OC) to ground sets the single-supply switching frequency. Figure 3 shows the relationship between this resistance and the converter switching frequency. The [EVAL-ADuM4070EBZ](#) can be configured with 0 Ω, 0603 resistors to set one of four preset switching frequencies. Table 4 lists the switching frequencies that can be selected by short- or open-circuiting R12, R13, and R14.

The user can select a different switching frequency by removing R12 and R13 and then choosing R18 based on Figure 3. The board is configured for the 500 kHz setting by default. Figure 4 and Figure 6 show how the switching frequency affects the efficiency of the supply using a Coilcraft transformer (CR7983-CL) and a Halo Electronics transformer (TGRAD-560V8LF), respectively. Figure 5 shows how the efficiency curves vary over temperature with a 500 kHz switching frequency.

Table 4. Switching Frequency Selection

R12	R13	R14	R _{OC}	Switching Frequency (f _{sw})
0 Ω	Open	Open	300 kΩ	200 kHz
Open	Open	0 Ω	100 kΩ	500 kHz (default)
0 Ω	Open	0 Ω	75 kΩ	700 kHz
0 Ω	0 Ω	0 Ω	50 kΩ	1 MHz

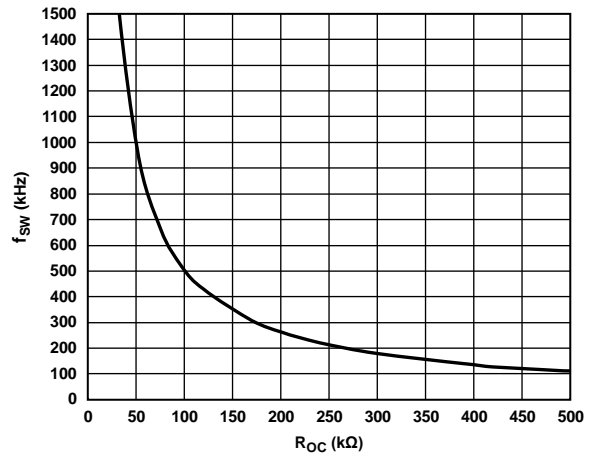

NOTES
 1. R_{OC} IS A CALCULATED VALUE BASED ON THE SELECTION OF R12, R13, AND R14.

Figure 3. Switching Frequency (f_{sw}) vs. Oscillator Resistance (R_{OC})

10683-003

OTHER INPUT AND ISOLATED OUTPUT SUPPLY OPTIONS

In the single-supply configuration, the board can be set up to have a 3.3 V secondary isolated supply with a 3.3 V or 5 V primary input supply. Short-circuiting R10 by soldering a 0 Ω, 0603 resistor to R9 sets the output supply to 3.3 V. The voltage at the feedback node (the FB pin of the [ADuM4070](#)) should be the desired output voltage divided to approximately 1.25 V. Having R10 open-circuited sets the secondary isolated supply to 5 V, and having R10 short-circuited sets the supply to 3.3 V. See the [ADuM4070](#) data sheet for more information about setting the secondary isolated output supply voltage. Figure 7 shows how the efficiency curves change in single-supply configuration when the board is reconfigured by open- or short-circuiting R10.

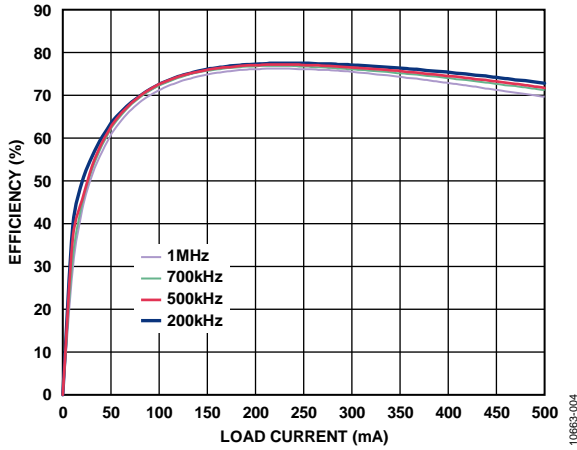

Figure 4. 5 V Input to 5 V Output Efficiency Using a 1CT:2CT Coilcraft Transformer (CR7983-CL) at Various Switching Frequencies

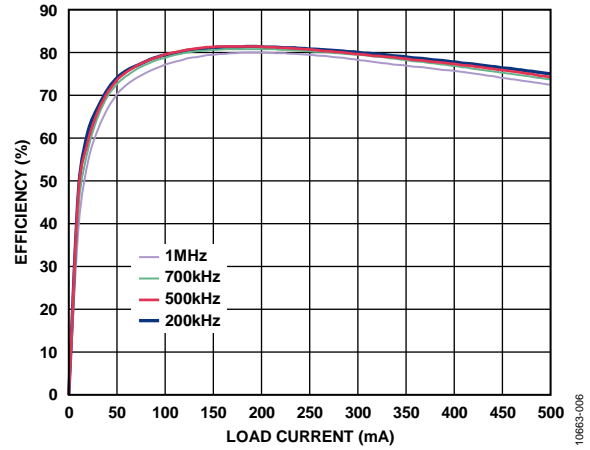

Figure 6. 5 V Input to 5 V Output Efficiency Using a 1CT:2CT Halo Electronics Transformer (TGRAD-560V8LF) at Various Switching Frequencies

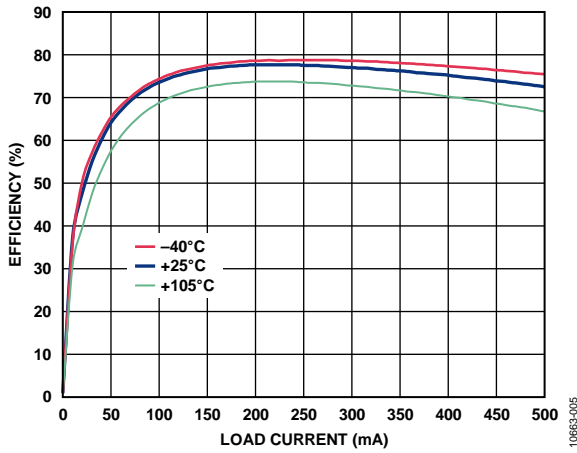

Figure 5. 5 V Input to 5 V Output Efficiency Using a 1CT:2CT Coilcraft Transformer (CR7983-CL) at 500 kHz Over Temperature

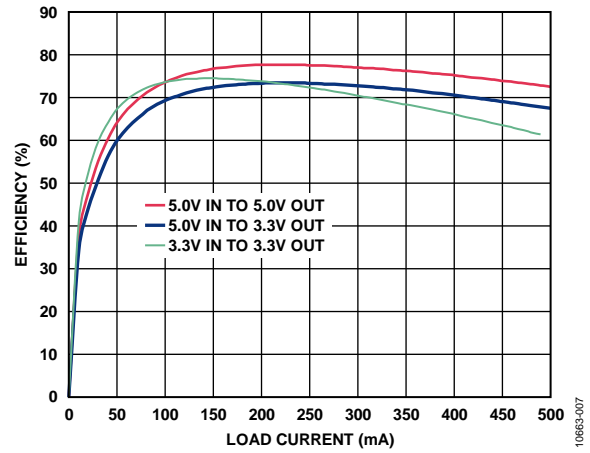

Figure 7. Single-Supply Efficiency for Various Output Configurations Using a 1CT:2CT Coilcraft Transformer (CR7983-CL) at 500 kHz

DOUBLE SUPPLY

The [ADuM4070](#) switching regulator on this evaluation board can be configured for double-supply output (for more information about the transformer, see the Transformer Selection section). When the [ADuM4070](#) is set to double-supply mode, the feedback divider resistors should be configured as described in Table 1 and the output mode resistors should be configured as described in Table 2.

By default, the double-supply configuration provides a regulated 15 V output and an unregulated 7.5 V output, which are isolated from the 5 V primary input supply. The double supply is capable of delivering up to 140 mA to external loads. The double supply can be reconfigured as 12 V (regulated) and 6 V (unregulated) secondary isolated supplies or as positive and negative supplies. See the Other Secondary Isolated Supply Configurations section for more information.

TERMINALS

In the double-supply configuration, the [EVAL-ADuM4070EBZ](#) board has terminal blocks on Side 1 (the primary/power supply input side) and Side 2 (the secondary/power supply output side). An 8.0 mm isolation barrier separates Side 1 from Side 2. Table 5 summarizes the functions of the terminal connections. These connections are described in detail in the Input Power Connections and Output Power Connections sections.

Input Power Connections

Connect 5 V to P1 (labeled 5V), and connect the negative end of the supply to P2 (labeled GND). These are the only off-board connections required for the board to function in double-supply configuration.

V_{DD1} is the [ADuM4070](#) transformer driver supply, and V_{DDA} is the primary supply voltage (see the [ADuM4070](#) data sheet for additional information). V_{DD1} and V_{DDA} are bypassed by a 47 μ F ceramic capacitor (C3) and a 0.1 μ F local bypass capacitor (C8) located close to the [ADuM4070](#). R4, R3, C4, and C5 are provided for an optional and unpopulated snubber, which can be used to reduce radiated emissions.

Output Power Connections

Output loads can be connected to P9 (labeled OUT2) and P7 (labeled OUT1), which are the isolated, unregulated 7.5 V and regulated 15 V output supplies, respectively. Connect the return of the load to P10 and P8, which are labeled ISO_GND.

Side 2 is powered by the secondary isolated 15 V supply. The [ADuM4070](#) internal low dropout regulator converts this voltage to 5 V. The regulated 5 V supply powers the [ADuM4070](#) secondary side. Therefore, the [ADuM4070](#) V_{REG} pin is 15 V, and the V_{DD2} pin is 5 V. The 15 V supply connects to P7 (labeled OUT1). The 7.5 V supply connects to P9 (labeled OUT2). The Side 2 ground reference is tied to P10. See the [ADuM4070](#) data sheet for an explanation of the double-supply theory of operation. Figure 8 through Figure 11 show efficiency curves for the double supply with the 15 V or 12 V isolated output supply connected to V_{REG} .

Powering V_{REG} from the Unregulated 7.5 V Supply

V_{REG} can be powered from the unregulated 7.5 V supply, which results in higher efficiency. However, when the 15 V supply is unloaded, the unregulated 7.5 V supply is approximately 3 V, which is insufficient for powering the [ADuM4070](#) secondary side. This causes the double supply to run open-loop, leaving the 15 V supply unregulated. Using 15 V for V_{REG} ensures that the secondary side of the [ADuM4070](#) powers up under light load conditions. Move the 0 Ω , 0603 resistor from R8 to R9 to power Side 2 from the 7.5 V supply.

Care must be taken to avoid driving an output pin because this can result in permanent damage to the [ADuM4070](#).

Table 5. Double-Supply Terminal Function Descriptions

Terminal	Label	Description
P1	5V	Side 1—5 V primary input supply
P2	GND	Side 1—ground reference
P9	OUT2	Side 2—7.5 V secondary isolated supply (unregulated)
P10	ISO_GND	Side 2—ground reference
P7	OUT1	Side 2—15 V secondary isolated supply (regulated)
P8	ISO_GND	Side 2—ground reference

TRANSFORMER SELECTION

The [EVAL-ADuM4070EBZ](#) supports multiple transformer options. In the double-supply configuration, the board must be equipped with a Halo Electronics TGRAD-590V8LF (T2) or a Coilcraft CR7984-CL (T3) 1CT:3CT turns ratio transformer (see the [ADuM4070](#) data sheet for details on transformer selection with the [ADuM4070](#)). Figure 8 and Figure 10 show the efficiency of the supply using a 1CT:3CT Coilcraft transformer (CR7984-CL) and a 1CT:3CT Halo Electronics transformer (TGRAD-590V8LF), respectively, at various switching frequencies. Figure 9 shows how temperature affects efficiency.

SWITCHING FREQUENCY OPTIONS

The resistance connected from the [ADuM4070](#) oscillator control pin (OC) to ground sets the double-supply switching frequency. Figure 3 shows the relationship between this resistance and the converter switching frequency. The [EVAL-ADuM4070EBZ](#) can be configured with 0 Ω , 0603 resistors to set one of four preset switching frequencies. Table 6 lists the switching frequencies that can be selected by short- or open-circuiting R12, R13, and R14.

The user can select a different switching frequency by removing R12 and R13 and then choosing R18 based on Figure 3. The board is configured for the 500 kHz setting by default. Figure 8 and Figure 10 show how the switching frequency affects the efficiency of the supply using a Coilcraft transformer (CR7984-CL) and a Halo Electronics transformer (TGRAD-590V8LF), respectively.

Table 6. Switching Frequency Selection

R12	R13	R14	Roc	Switching Frequency (f _{sw})
0 Ω	Open	Open	300 kΩ	200 kHz
Open	Open	0 Ω	100 kΩ	500 kHz (default)
0 Ω	Open	0 Ω	75 kΩ	700 kHz
0 Ω	0 Ω	0 Ω	50 kΩ	1 MHz

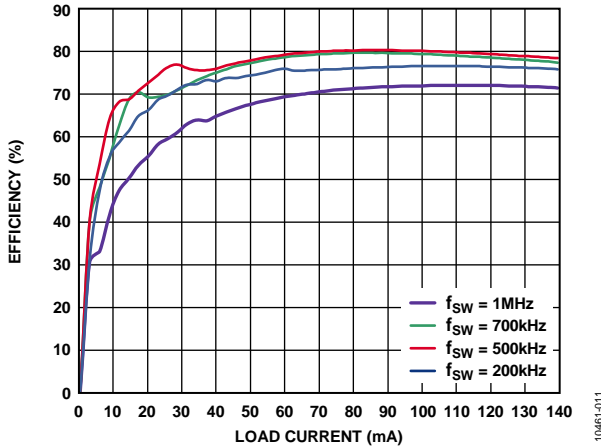

Figure 8. 5 V Input to 15 V Output Efficiency Using a 1CT:3CT Coilcraft Transformer (CR7984-CL) at Various Switching Frequencies

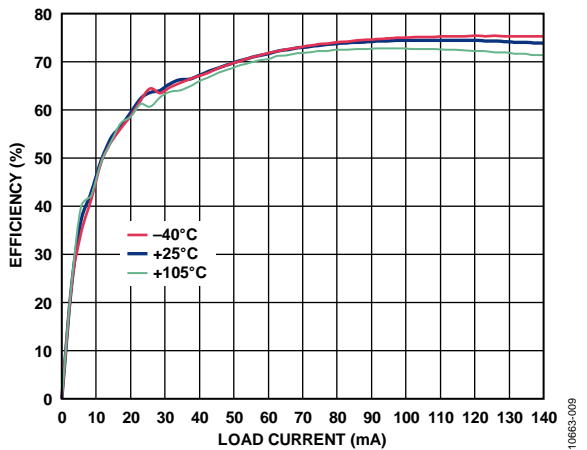

Figure 9. 5 V Input to 15 V Output Efficiency Using a 1CT:3CT Coilcraft Transformer (CR7984-CL) at 500 kHz and Various Temperatures

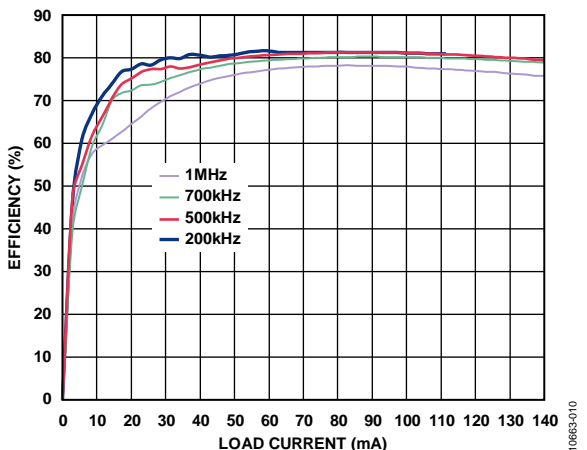

Figure 10. 5 V Input to 15 V Output Efficiency Using a 1CT:3CT Halo Electronics Transformer (TGRAD-590V8LF) at Various Switching Frequencies

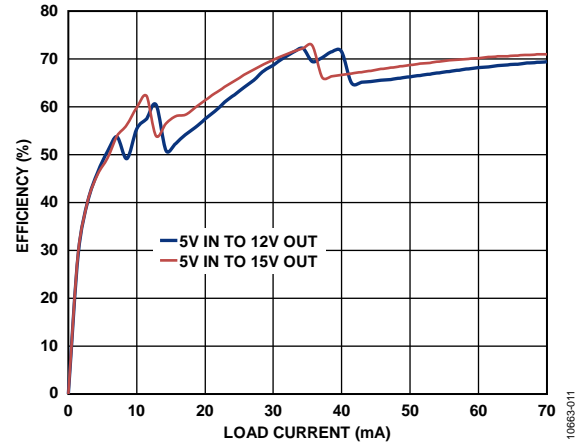

Figure 11. Double-Supply Efficiency for Various Output Configurations Using a 1CT:5CT Coilcraft Transformer (CR7984-CL) at 500 kHz

OTHER SECONDARY ISOLATED SUPPLY CONFIGURATIONS

In the double-supply configuration, the EVAL-ADuM4070EBZ board can be configured to have 12 V regulated and 6 V unregulated secondary isolated supplies by short-circuiting R11 with a 0 Ω resistor for R10. The regulated supply voltage is set by the fraction of it that is fed back to the ADuM4070 via the voltage divider comprising R6, R11, R15, and R10. The voltage at the feedback pin (FB) is 1.25 V. With R10 open-circuited, the ADuM4070 feedback voltage is approximately 1.25 V if V_{ISO} is 15 V. When R10 is short-circuited, the feedback voltage is approximately 1.25 V if V_{ISO} is 12 V (see the ADuM4070 data sheet for more information about setting the secondary isolated output supply voltage). Figure 11 shows the efficiency curves for both output settings at 500 kHz using a Coilcraft transformer (CR7984-CL).

Positive and Negative Outputs

In the double-supply configuration, the EVAL-ADuM4070EBZ board can be set up to have a positive and negative ±15 V supply by changing the transformer to a turns ratio 1CT:5CT transformer (see the ADuM4070 data sheet for more information about these transformers). Other changes begin with removing the 0 Ω resistors from R5 and R8 and inserting them into R7 and R9. Short-circuiting R2 instead of R1 changes the unregulated 7.5 V supply into a -15 V supply. Short-circuiting R5 instead of R7 connects the transformer center tap to the ground plane instead of the node where L2 and C2 are connected. Note that the negative supply is unregulated. The positive and negative supplies can be set for ±12 V instead of ±15 V by short-circuiting R10.

Although the +15 V output can be regulated, the same problems with regulation can occur as described in the Powering V_{REG} from the Unregulated 7.5 V Supply section. In addition, the -15 V supply can vary over a wide range because it is unregulated and influenced by the changes that occur on the +15 V output.

EVALUATION BOARD SCHEMATIC AND ARTWORK

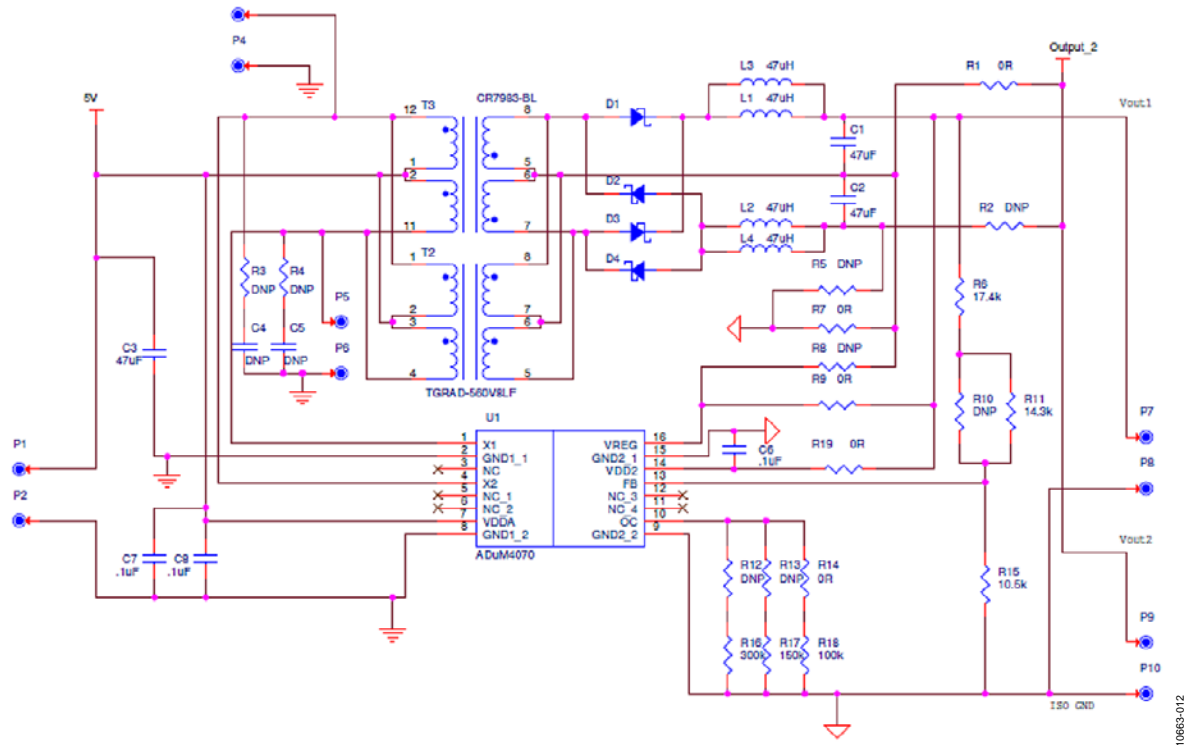

Figure 12. Evaluation Board Schematic

EVALUATION BOARD LAYOUT

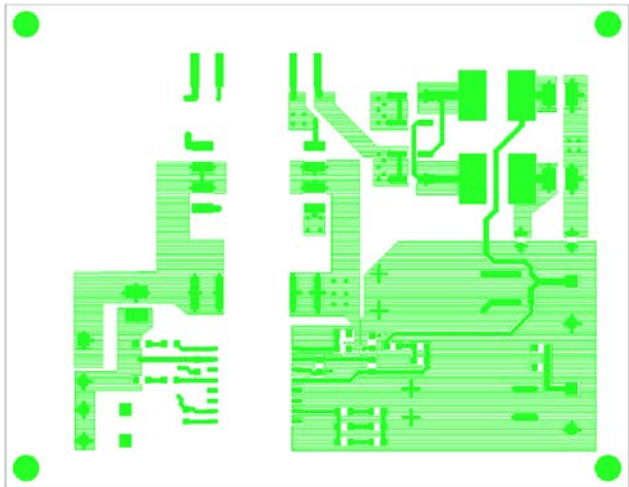

Figure 13. Top Layer: Ground Fill

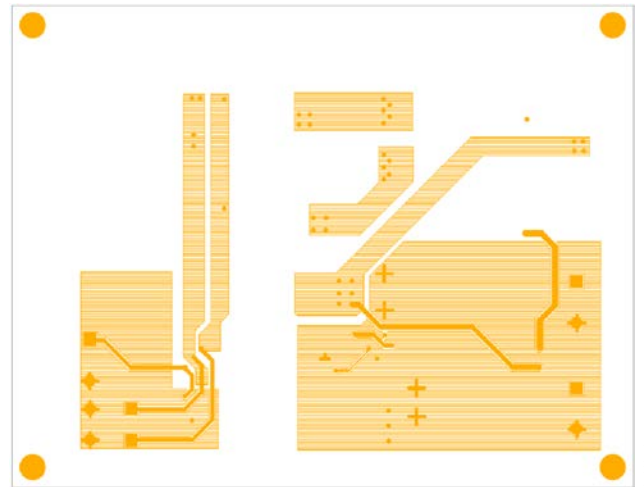

Figure 14. Bottom Layer: Ground Fill

BILL OF MATERIALS

Table 7.

Qty	Reference Designator	Description	Supplier/Part Number
1	U1	Isolated switching regulator with integrated feedback	Analog Devices, Inc./ ADuM4070ARIZ
4	D1 to D4	Schottky barrier rectifier, 0.5 A, 40 V, SMD, SOD-123	ON Semiconductor/MBR0540
1	T2 ¹	Transformer, 1CT:2CT turns ratio, SMD (not populated)	Halo Electronics/TGRAD-560V6LF
1	T3 ¹	Transformer, 1CT:2CT turns ratio, SMD	Coilcraft/CR7983-CL
3	C1, C2, C3	Capacitor, ceramic, X7R, SMD, 1210, 47 μ F, 20%, 10 V	Murata/GRM32ER71A476KE15L
2	C4, C5	Capacitor, ceramic, SMD, 0603 (not populated)	N/A
3	C6, C7, C8	Capacitor, ceramic, X7R, SMD, 0603, 0.1 μ F	AVX/0603YC104KAT2A
2	L1, L2	Inductor, SMD, 2424, 47 μ H, 20%, 0.17 Ω (not populated)	Murata/LQH6PPN470M43
2	L3, L4	Inductor, SMD, 1212, 47 μ H, 20%, 1.25 Ω	Murata/LQH3NPN470MM0
6	R1, R7, R9, R11, R14, R19	Resistor chip, SMD, 0805, 0 Ω , 1/8 W	Panasonic/ECG/ERJ-6GEY0R00V
8	R2, R3, R4, R5, R8, R10, R12, R13	Not populated	N/A
1	R6	Resistor chip, SMD, 0805, 17.4 k Ω , 1/8 W, 1%	Panasonic/ECG/ERJ-6ENF1742V
1	R16	Resistor chip, SMD, 0805, 300 k Ω , 1/8 W, 1%	Yageo/RC0805FR-07300KL
1	R17	Resistor chip, SMD, 0805, 150 k Ω , 1/8 W, 1%	Yageo/RC0805FR-07150KL
1	R18	Resistor chip, SMD, 0805, 100 k Ω , 1/8 W, 1%	Panasonic/ECG/ERJ-6ENF1003V
1	R15	Resistor chip, SMD, 0805, 10.5 k Ω , 1/8 W, 1%	Panasonic/ECG/ERJ-6ENF1052V
1	R11	Resistor chip, SMD, 0805, 14.3 k Ω , 1/8 W, 1%	Panasonic/ECG/ERJ-6ENF1432V
5	P1, P3, P5, P7, P9	Test point, red	Components Corp./TP-104 series
5	P2, P4, P6, P8, P10	Test point, black	Components Corp./TP-104 series

¹ The board can be populated with either a Coilcraft transformer or a Halo Electronics transformer. Do not populate both T2 and T3.

NOTES

NOTES

**ESD Caution**

ESD (electrostatic discharge) sensitive device. Charged devices and circuit boards can discharge without detection. Although this product features patented or proprietary protection circuitry, damage may occur on devices subjected to high energy ESD. Therefore, proper ESD precautions should be taken to avoid performance degradation or loss of functionality.

Legal Terms and Conditions

By using the evaluation board discussed herein (together with any tools, components documentation or support materials, the "Evaluation Board"), you are agreeing to be bound by the terms and conditions set forth below ("Agreement") unless you have purchased the Evaluation Board, in which case the Analog Devices Standard Terms and Conditions of Sale shall govern. Do not use the Evaluation Board until you have read and agreed to the Agreement. Your use of the Evaluation Board shall signify your acceptance of the Agreement. This Agreement is made by and between you ("Customer") and Analog Devices, Inc. ("ADI"), with its principal place of business at One Technology Way, Norwood, MA 02062, USA. Subject to the terms and conditions of the Agreement, ADI hereby grants to Customer a free, limited, personal, temporary, non-exclusive, non-sublicensable, non-transferable license to use the Evaluation Board FOR EVALUATION PURPOSES ONLY. Customer understands and agrees that the Evaluation Board is provided for the sole and exclusive purpose referenced above, and agrees not to use the Evaluation Board for any other purpose. Furthermore, the license granted is expressly made subject to the following additional limitations: Customer shall not (i) rent, lease, display, sell, transfer, assign, sublicense, or distribute the Evaluation Board; and (ii) permit any Third Party to access the Evaluation Board. As used herein, the term "Third Party" includes any entity other than ADI, Customer, their employees, affiliates and in-house consultants. The Evaluation Board is NOT sold to Customer; all rights not expressly granted herein, including ownership of the Evaluation Board, are reserved by ADI. CONFIDENTIALITY. This Agreement and the Evaluation Board shall all be considered the confidential and proprietary information of ADI. Customer may not disclose or transfer any portion of the Evaluation Board to any other party for any reason. Upon discontinuation of use of the Evaluation Board or termination of this Agreement, Customer agrees to promptly return the Evaluation Board to ADI. ADDITIONAL RESTRICTIONS. Customer may not disassemble, decompile or reverse engineer chips on the Evaluation Board. Customer shall inform ADI of any occurred damages or any modifications or alterations it makes to the Evaluation Board, including but not limited to soldering or any other activity that affects the material content of the Evaluation Board. Modifications to the Evaluation Board must comply with applicable law, including but not limited to the RoHS Directive. TERMINATION. ADI may terminate this Agreement at any time upon giving written notice to Customer. Customer agrees to return to ADI the Evaluation Board at that time. LIMITATION OF LIABILITY. THE EVALUATION BOARD PROVIDED HEREUNDER IS PROVIDED "AS IS" AND ADI MAKES NO WARRANTIES OR REPRESENTATIONS OF ANY KIND WITH RESPECT TO IT. ADI SPECIFICALLY DISCLAIMS ANY REPRESENTATIONS, ENDORSEMENTS, GUARANTEES, OR WARRANTIES, EXPRESS OR IMPLIED, RELATED TO THE EVALUATION BOARD INCLUDING, BUT NOT LIMITED TO, THE IMPLIED WARRANTY OF MERCHANTABILITY, TITLE, FITNESS FOR A PARTICULAR PURPOSE OR NON-INFRINGEMENT OF INTELLECTUAL PROPERTY RIGHTS. IN NO EVENT WILL ADI AND ITS LICENSORS BE LIABLE FOR ANY INCIDENTAL, SPECIAL, INDIRECT, OR CONSEQUENTIAL DAMAGES RESULTING FROM CUSTOMER'S POSSESSION OR USE OF THE EVALUATION BOARD, INCLUDING BUT NOT LIMITED TO LOST PROFITS, DELAY COSTS, LABOR COSTS OR LOSS OF GOODWILL. ADI'S TOTAL LIABILITY FROM ANY AND ALL CAUSES SHALL BE LIMITED TO THE AMOUNT OF ONE HUNDRED US DOLLARS (\$100.00). EXPORT. Customer agrees that it will not directly or indirectly export the Evaluation Board to another country, and that it will comply with all applicable United States federal laws and regulations relating to exports. GOVERNING LAW. This Agreement shall be governed by and construed in accordance with the substantive laws of the Commonwealth of Massachusetts (excluding conflict of law rules). Any legal action regarding this Agreement will be heard in the state or federal courts having jurisdiction in Suffolk County, Massachusetts, and Customer hereby submits to the personal jurisdiction and venue of such courts. The United Nations Convention on Contracts for the International Sale of Goods shall not apply to this Agreement and is expressly disclaimed.