

Bridgelux® Gen 7 V10 Array Series

Product Data Sheet DS100



Introduction

V Series



The V Series™ LED Array products deliver high quality light in a compact and cost-effective solid-state lighting package. These chip on board (CoB) arrays can be efficiently driven at twice the nominal drive current, enabling design flexibility not previously possible. This high flux density light source is designed to support a wide range of high quality, low cost directional luminaires and replacement lamps for commercial and residential applications.

The V10 LED array is available in a variety of electrical, CCT and CRI combinations providing substantial design flexibility and energy efficiencies.

Lighting system designs incorporating these LED arrays deliver increased system level efficacy and longer service life. Typical applications include, replacement lamps, and task, accent, spot, track, wide area, security, wall pack and down lights.

Bridgelux Décor Series is our state of the art color line designed specifically for premium applications, producing unmatched LED light quality with brilliant color-rendering options and offer pleasing and inspiring lighting palettes. Bridgelux Décor Series color points are available on Vero® SE Series, Vero® Series, V Series™ and H Series™.

Décor Series Class A is based on human response testing, providing color points with a combined GAI and CRI metric.

Décor Series™ Ultra products provide a high CRI of 97 and a minimum R9 value of 93, which emphasizes the reds and color tones to which the human eye is most receptive - perfect for the most luxurious retail shops and world renowned museums. Décor Series Ultra is designed as a replacement for halogen.

Décor Series™ Street and Landmark is designed to be a direct replacement for high pressure sodium lamps.

Décor Series™ Showcase is the optimal solution for replacing ceramic metal halide lamps, incorporating the same pure white light with enhanced spectrum coverage and higher efficacy.

Features

- Efficacy of 155 lm/W typical
- Compact high flux density light source
- Uniform high quality illumination
- Minimum 65, 70, 80 and 90 and 95 CRI options
- Streamlined thermal path
- ENERGY STAR® / ANSI compliant color binning structure with 2, 3 and 4 SDCM options
- More energy efficient than incandescent, halogen and fluorescent lamps
- Low voltage DC operation
- Instant light with unlimited dimming
- V_f bin code backside marking

Benefits

- Enhanced optical control
- Clean white light without pixilation
- High quality true color reproduction
- Significantly reduced thermal resistance and increased operating temperatures
- Uniform consistent white light
- Lower operating costs
- Easy to use with daylight and motion detectors to enable increased energy savings
- Reduced maintenance costs
- Environmentally friendly, no disposal issue



Contents

Product Feature Map	2
Product Nomenclature	2
Product Selection Guide	3
Performance at Commonly Used Drive Currents	7
Electrical Characteristics	12
Eye Safety	13
Absolute Maximum Ratings	14
Performance Curves	15
Typical Radiation Pattern	18
Typical Color Spectrum	19
Mechanical Dimensions	20
Color Binning Information	21
Packaging and Labeling	22
Design Resources	24
Precautions	24
Disclaimers	24
About Bridgelux	25

Product Selection Guide

The following product configurations are available:

Table 1: Selection Guide, Pulsed Measurement Data ($T_j = T_c = 25^\circ\text{C}$)

Part Number	Nominal CCT ¹ (K)	CRI ²	Nominal Drive Current ³ (mA)	Typical Pulsed Flux ^{4,5,6} $T_c = 25^\circ\text{C}$ (lm)	Minimum Pulsed Flux ^{6,7} $T_c = 25^\circ\text{C}$ (lm)	Typical V_f (V)	Typical Power (W)	Typical Efficacy (lm/W)
BXRE-20B1000-B-73	2000	65	270	1372	1208	34.8	9.4	145
BXRE-27E1000-B-7X	2700	80	270	1394	1226	34.8	9.4	148
BXRE-27E1000-C-7X	2700	80	360	1858	1635	34.8	12.5	148
BXRE-27G1000-B-7X	2700	90	270	1161	1022	34.8	9.4	124
BXRE-27G1000-C-7X	2700	90	360	1548	1363	34.8	12.5	124
BXRE-27H1000-B-7X	2700	97	270	1006	886	34.8	9.4	107
BXRE-30E1000-B-7X	3000	80	270	1452	1277	34.8	9.4	155
BXRE-30E1000-C-7X	3000	80	360	1936	1703	34.8	12.5	155
BXRE-30G1000-B-7X	3000	90	270	1210	1065	34.8	9.4	129
BXRE-30G1000-C-7X	3000	90	360	1613	1419	34.8	12.5	129
BXRE-30G100C-B-73	3000	90	270	1123	988	34.8	9.4	119
BXRE-30G100C-C-73	3000	90	360	1497	1317	34.8	12.5	119
BXRE-30A1001-B-73 ^{8,9}	3000	93	270	1090	959	34.8	9.4	116
BXRE-30A1001-C-73 ^{8,9}	3000	93	360	1453	1279	34.8	12.5	116
BXRE-30H1000-B-7X	3000	97	270	1084	954	34.8	9.4	115
BXRE-35E1000-B-7X	3500	80	270	1500	1320	34.8	9.4	160
BXRE-35E1000-C-7X	3500	80	360	2000	1760	34.8	12.5	160
BXRE-35G1000-B-7X	3500	90	270	1248	1099	34.8	9.4	133
BXRE-35G1000-C-7X	3500	90	360	1665	1465	34.8	12.5	133
BXRE-35A1001-B-73 ^{8,9}	3500	93	270	1175	1034	34.8	9.4	125
BXRE-35A1001-C-73 ^{8,9}	3500	93	360	1566	1378	34.8	12.5	125
BXRE-40E1000-B-7X	4000	80	270	1510	1329	34.8	9.4	161
BXRE-40E1000-C-7X	4000	80	360	2013	1771	34.8	12.5	161
BXRE-40G1000-B-7X	4000	90	270	1297	1141	34.8	9.4	138
BXRE-40G1000-C-7X	4000	90	360	1729	1522	34.8	12.5	138
BXRE-50C1001-B-7X	5000	70	270	1655	1456	34.8	9.4	176
BXRE-50C1001-C-7X	5000	70	360	2207	1942	34.8	12.5	176
BXRE-50E1001-B-7X	5000	80	270	1558	1371	34.8	9.4	166
BXRE-50E1001-C-7X	5000	80	360	2078	1828	34.8	12.5	166
BXRE-50G1001-B-7X	5000	90	270	1316	1158	34.8	9.4	140
BXRE-50G1001-C-7X	5000	90	360	1755	1544	34.8	12.5	140
BXRE-57C1001-B-7X	5700	70	270	1597	1405	34.8	9.4	170

Notes for Table 1:

- Nominal CCT as defined by ANSI C78.377-2011. Products with a CCT of 5000K-6500K are hot targeted to $T_c = 85^\circ\text{C}$.
- CRI values are typical for Decor Series Ultra and Decor Series Class A products. CRI values are minimums for all other products. Minimum Rg value for 80 CRI products is 0, the minimum Rg values for 90 CRI products is 50, the minimum Rg values for 97 CRI products is 93. Bridgelux maintains a ± 3 tolerance on Rg values.
- Drive current is referred to as nominal drive current.
- Products tested under pulsed condition (10ms pulse width) at nominal test current where T_j (junction temperature) - T_c (case temperature) = 25°C .
- Typical performance values are provided as a reference only and are not a guarantee of performance.
- Bridgelux maintains a $\pm 7\%$ tolerance on flux measurements.
- Minimum flux values at the nominal test current are guaranteed by 100% test.
- Nominal CCT is defined by the Lighting Research Center's Class A definition. The center of the Class A color bin is on the corresponding isothermal line.
- GAI value is 80. To help ensure optimal fixture level performance, GAI is measured at the fixture level, on axis, at a case temperature of 70°C . GAI may vary depending on fixture design and performance.

Product Selection Guide

Table 1: Selection Guide, Pulsed Measurement Data ($T_j = T_c = 25^\circ\text{C}$)

Part Number	Nominal CCT ¹ (K)	CRI ²	Nominal Drive Current ³ (mA)	Typical Pulsed Flux ^{4,5,6} $T_c = 25^\circ\text{C}$ (lm)	Minimum Pulsed Flux ^{6,7} $T_c = 25^\circ\text{C}$ (lm)	Typical V_f (V)	Typical Power (W)	Typical Efficacy (lm/W)
BXRE-57C1001-C-7x	5700	70	360	2129	1874	34.8	12.5	170
BXRE-57E1001-B-7x	5700	80	270	1541	1356	34.8	9.4	164
BXRE-57E1001-C-7x	5700	80	360	2055	1808	34.8	12.5	164
BXRE-65C1001-B-7x	6500	70	270	1626	1431	34.8	9.4	173
BXRE-65C1001-C-7x	6500	70	360	2168	1908	34.8	12.5	173
BXRE-65E1001-B-7x	6500	80	270	1569	1381	34.8	9.4	167
BXRE-65E1001-C-7x	6500	80	360	2092	1841	34.8	12.5	167

Notes for Table 1:

- Nominal CCT as defined by ANSI C78.377-2011. Products with a CCT of 5000K-6500K are hot targeted to $T_c = 85^\circ\text{C}$.
- CRI values are typical for Decor Series Ultra and Decor Series Class A products. CRI values are minimums for all other products. Minimum R9 value for 80 CRI products is 0, the minimum R9 values for 90 CRI products is 50, the minimum R9 values for 97 CRI products is 93. Bridgelux maintains a ± 3 tolerance on R9 values.
- Drive current is referred to as nominal drive current.
- Products tested under pulsed condition (10ms pulse width) at nominal test current where T_j (junction temperature) - T_c (case temperature) = 25°C .
- Typical performance values are provided as a reference only and are not a guarantee of performance.
- Bridgelux maintains a $\pm 7\%$ tolerance on flux measurements.
- Minimum flux values at the nominal test current are guaranteed by 100% test.
- Nominal CCT is defined by the Lighting Research Center's Class A definition. The center of the Class A color bin is on the corresponding isothermal line.
- GAI value is 80. To help ensure optimal fixture level performance, GAI is measured at the fixture level, on axis, at a case temperature of 70°C . GAI may vary depending on fixture design and performance.

Table 2: Selection Guide, Stabilized DC Performance ($T_c = 70^\circ\text{C}$)^{7,8}

Part Number	Nominal CCT ¹ (K)	GAI ²	CRI ³	Nominal Drive Current ⁴ (mA)	Typical DC Flux ^{5,6} $T_c = 70^\circ\text{C}$ (lm)	Minimum DC Flux ^{6,9} $T_c = 70^\circ\text{C}$ (lm)	Typical V_f (V)	Typical Power (W)	Typical Efficacy (lm/W)
BXRE-30A1001-B-73	3000	80	93	270	1014	892	34.3	9.3	109
BXRE-30A1001-C-73	3000	80	93	360	1352	1189	34.3	12.3	109
BXRE-35A1001-B-73	3500	80	93	270	1092	961	34.3	9.3	118
BXRE-35A1001-C-73	3500	80	93	360	1456	1282	34.3	12.3	118

Notes for Table 2:

- Nominal CCT is defined by the Lighting Research Center's Class A definition. The center of the Class A color bin is on the corresponding isothermal line.
- To help ensure optimal fixture level performance, GAI is measured at the fixture level, on axis, at a case temperature of 70°C . GAI may vary depending on fixture design and performance.
- All CRI values are measured at $T_j = T_c = 25^\circ\text{C}$. CRI Values are specified as typical.
- Drive current is referred to as nominal drive current.
- Typical performance values are provided as a reference only and are not a guarantee of performance.
- Bridgelux maintains a $\pm 7\%$ tolerance on flux measurements.
- Typical stabilized DC performance values are provided as reference only and are not a guarantee of performance.
- Typical performance is estimated based on operation under DC (direct current) with LED array mounted onto a heat sink with thermal interface material and the case temperature maintained at specified temperature. Based on Bridgelux test setup, values may vary depending on the thermal design of the luminaire and/or the exposed environment to which the product is subjected.
- Minimum flux values at elevated temperatures are provided for reference only and are not guaranteed by 100% production testing. Based on Bridgelux test setup, values may vary depending on the thermal design of the luminaire and/or the exposed environment to which the product is subjected.

Product Selection Guide

Table 3: Selection Guide, Stabilized DC Performance ($T_c = 85^\circ\text{C}$)^{4,5}

Part Number	Nominal CCT ¹ (K)	CRI ²	Nominal Drive Current ³ (mA)	Typical DC Flux ^{4,5} $T_c = 85^\circ\text{C}$ (lm)	Minimum DC Flux ⁶ $T_c = 85^\circ\text{C}$ (lm)	Typical V_f (V)	Typical Power (W)	Typical Efficacy (lm/W)
BXRE-20B1000-B-73	2000	65	270	1235	1087	33.8	9.1	135
BXRE-27E1000-B-7X	2700	80	270	1254	1104	33.8	9.1	137
BXRE-27E1000-C-7X	2700	80	360	1672	1472	33.8	12.2	137
BXRE-27G1000-B-7X	2700	90	270	1045	920	33.8	9.1	114
BXRE-27G1000-C-7X	2700	90	360	1394	1226	33.8	12.2	114
BXRE-27H1000-B-7X	2700	97	270	906	797	33.8	9.1	99
BXRE-30E1000-B-7X	3000	80	270	1307	1150	33.8	9.1	143
BXRE-30E1000-C-7X	3000	80	360	1742	1533	33.8	12.2	143
BXRE-30G1000-B-7X	3000	90	270	1089	958	33.8	9.1	119
BXRE-30G1000-C-7X	3000	90	360	1452	1277	33.8	12.2	119
BXRE-30G100C-B-73	3000	90	270	1010	889	33.8	9.1	111
BXRE-30G100C-C-73	3000	90	360	1347	1186	33.8	12.2	111
BXRE-30A1001-B-73 ^{7,8}	3000	93	270	981	863	33.8	9.1	107
BXRE-30A1001-C-73 ^{7,8}	3000	93	360	1308	1151	33.8	12.2	107
BXRE-30H1000-B-7X	3000	97	270	976	858	33.8	9.1	107
BXRE-35E1000-B-7X	3500	80	270	1350	1188	33.8	9.1	148
BXRE-35E1000-C-7X	3500	80	360	1800	1584	33.8	12.2	148
BXRE-35G1000-B-7X	3500	90	270	1124	989	33.8	9.1	123
BXRE-35G1000-C-7X	3500	90	360	1498	1318	33.8	12.2	123
BXRE-35A1001-B-73 ^{7,8}	3500	93	270	1057	930	33.8	9.1	116
BXRE-35A1001-C-73 ^{7,8}	3500	93	360	1409	1240	33.8	12.2	116
BXRE-40E1000-B-7X	4000	80	270	1359	1196	33.8	9.1	149
BXRE-40E1000-C-7X	4000	80	360	1812	1594	33.8	12.2	149
BXRE-40G1000-B-7X	4000	90	270	1167	1027	33.8	9.1	128
BXRE-40G1000-C-7X	4000	90	360	1556	1369	33.8	12.2	128
BXRE-50C1001-B-7X	5000	70	270	1489	1311	33.8	9.1	163
BXRE-50C1001-C-7X	5000	70	360	1986	1748	33.8	12.2	163
BXRE-50E1001-B-7X	5000	80	270	1402	1234	33.8	9.1	154
BXRE-50E1001-C-7X	5000	80	360	1870	1645	33.8	12.2	154
BXRE-50G1001-B-7X	5000	90	270	1185	1042	33.8	9.1	130
BXRE-50G1001-C-7X	5000	90	360	1579	1390	33.8	12.2	130
BXRE-57C1001-B-7X	5700	70	270	1437	1265	33.8	9.1	157

Notes for Table 3:

- Nominal CCT as defined by ANSI C78.377-2011. Products with a CCT of 5000K-6500K are hot targeted to $T_c = 85^\circ\text{C}$.
- All CRI values are measured at $T_c = T_a = 25^\circ\text{C}$. CRI values are typical for Decor Series Ultra and Decor Series Class A products. CRI values are minimums for all other products. Minimum R_g value for 80 CRI products is 0, the minimum R_g values for 90 CRI products is 50, the minimum R_g values for 97 CRI products is 93. Bridgelux maintains a ± 3 tolerance on R_g values.
- Drive current is referred to as nominal drive current.
- Typical stabilized DC performance values are provided as reference only and are not a guarantee of performance.
- Typical performance is estimated based on operation under DC (direct current) with LED array mounted onto a heat sink with thermal interface material and the case temperature maintained at 85°C . Based on Bridgelux test setup, values may vary depending on the thermal design of the luminaire and/or the exposed environment to which the product is subjected.
- Minimum flux values at elevated temperatures are provided for reference only and are not guaranteed by 100% production testing. Based on Bridgelux test setup, values may vary depending on the thermal design of the luminaire and/or the exposed environment to which the product is subjected.
- Nominal CCT is defined by the Lighting Research Center's Class A definition. The center of the Class A color bin is on the corresponding isothermal line.
- GAI value is 80. To help ensure optimal fixture level performance, GAI is measured at the fixture level, on axis, at a case temperature of 70°C . GAI may vary depending on fixture design and performance.

Product Selection Guide

Table 3: Selection Guide, Stabilized DC Performance ($T_c = 85^\circ\text{C}$)^{4,5}

Part Number	Nominal CCT ¹ (K)	CRI ²	Nominal Drive Current ³ (mA)	Typical DC Flux ^{4,5} $T_c = 85^\circ\text{C}$ (lm)	Minimum DC Flux ⁶ $T_c = 85^\circ\text{C}$ (lm)	Typical V_f (V)	Typical Power (W)	Typical Efficacy (lm/W)
BXRE-57C1001-C-7X	5700	70	360	1916	1686	33.8	12.2	157
BXRE-57E1001-B-7X	5700	80	270	1387	1220	33.8	9.1	152
BXRE-57E1001-C-7X	5700	80	360	1849	1627	33.8	12.2	152
BXRE-65C1001-B-7X	6500	70	270	1463	1288	33.8	9.1	160
BXRE-65C1001-C-7X	6500	70	360	1951	1717	33.8	12.2	160
BXRE-65E1001-B-7X	6500	80	270	1412	1243	33.8	9.1	155
BXRE-65E1001-C-7X	6500	80	360	1883	1657	33.8	12.2	155

Notes for Table 3:

- Nominal CCT as defined by ANSI C78.377-2011. Products with a CCT of 5000K-6500K are hot targeted to $T_c = 85^\circ\text{C}$.
- All CRI values are measured at $T_s = T_c = 25^\circ\text{C}$. CRI values are typical for Decor Series Ultra and Decor Series Class A products. CRI values are minimums for all other products. Minimum Rg value for 80 CRI products is 0, the minimum Rg values for 90 CRI products is 50, the minimum Rg values for 97 CRI products is 93. Bridgelux maintains a ± 3 tolerance on Rg values.
- Drive current is referred to as nominal drive current.
- Typical stabilized DC performance values are provided as reference only and are not a guarantee of performance.
- Typical performance is estimated based on operation under DC (direct current) with LED array mounted onto a heat sink with thermal interface material and the case temperature maintained at 85°C . Based on Bridgelux test setup, values may vary depending on the thermal design of the luminaire and/or the exposed environment to which the product is subjected.
- Minimum flux values at elevated temperatures are provided for reference only and are not guaranteed by 100% production testing. Based on Bridgelux test setup, values may vary depending on the thermal design of the luminaire and/or the exposed environment to which the product is subjected.
- Nominal CCT is defined by the Lighting Research Center's Class A definition. The center of the Class A color bin is on the corresponding isothermal line.
- GAI value is 80. To help ensure optimal fixture level performance, GAI is measured at the fixture level, on axis, at a case temperature of 70°C . GAI may vary depending on fixture design and performance.

Performance at Commonly Used Drive Currents

V Series LED arrays are tested to the specifications shown using the nominal drive currents in Table 1. V Series LED Arrays may also be driven at other drive currents dependent on specific application design requirements. The performance at any drive current can be derived from the current vs. voltage characteristics shown in Figures 1 & 2 and the flux vs. current characteristics shown in Figures 3 & 4. The performance at commonly used drive currents is summarized in Table 4.

Table 4: Product Performance at Commonly Used Drive Currents

Part Number	CRI	Drive Current ¹ (mA)	Typical V _f T _c = 25°C (V)	Typical Power T _c = 25°C (W)	Typical Flux ² T _c = 25°C (lm)	Typical DC Flux ³ T _c = 85°C (lm)	Typical Efficacy T _c = 25°C (lm/W)
BXRE-20B1001-B-73	65	135	33.2	4.5	731	657	163
		180	34.0	6.1	959	860	157
		270	34.8	9.4	1372	1235	146
		405	35.6	14.4	2013	1791	140
		540	36.1	19.5	2579	2283	132
BXRE-27E1000-B-7X	80	135	33.2	4.5	743	667	166
		180	34.0	6.1	974	873	159
		270	34.8	9.4	1394	1254	148
		405	35.6	14.4	2045	1819	142
		540	36.1	19.5	2619	2318	134
BXRE-27E1000-C-7X	80	180	33.2	6.0	988	882	165
		240	34.0	8.2	1294	1150	159
		360	34.8	12.5	1858	1672	148
		540	35.6	19.2	2706	2351	141
		720	36.1	26.0	3456	2959	133
BXRE-27G1000-B-7X	90	135	33.2	4.5	619	556	138
		180	34.0	6.1	811	728	133
		270	34.8	9.4	1161	1045	124
		405	35.6	14.4	1704	1516	118
		540	36.1	19.5	2183	1932	112
BXRE-27G1000-C-7X	90	180	33.2	6.0	823	735	138
		240	34.0	8.2	1079	958	132
		360	34.8	12.5	1548	1394	124
		540	35.6	19.2	2255	1959	117
		720	36.1	26.0	2880	2405	111
BXRE-27H1000-B-7X	97	135	33.2	4.5	536	482	120
		180	34.0	6.1	703	631	115
		270	34.8	9.4	1006	906	107
		405	35.6	14.4	1477	1314	102
		540	36.1	19.5	1892	1674	97
BXRE-30E1000-B-7X	80	135	33.2	4.5	774	695	173
		180	34.0	6.1	1014	910	166
		270	34.8	9.4	1452	1307	155
		405	35.6	14.4	2130	1895	148
		540	36.1	19.5	2728	2415	140
BXRE-30E1000-C-7X	80	180	33.2	6.0	1029	918	172
		240	34.0	8.2	1348	1198	165
		360	34.8	12.5	1936	1742	155
		540	35.6	19.2	2818	2448	146
		720	36.1	26.0	3600	3082	138

Notes for Table 4:

1. Alternate drive currents are provided for reference only and are not a guarantee of performance.
2. Bridgelux maintains a ± 7% tolerance on flux measurements.
3. Typical stabilized DC performance values are provided as reference only and are not a guarantee of performance.

Performance at Commonly Used Drive Currents

Table 4: Product Performance at Commonly Used Drive Currents (Continued)

Part Number	CRI	Drive Current ¹ (mA)	Typical V _f T _c = 25°C (V)	Typical Power T _c = 25°C (W)	Typical Flux ² T _c = 25°C (lm)	Typical DC Flux ³ T _c = 85°C (lm)	Typical Efficacy T _c = 25°C (lm/W)
BXRE-30G1000-B-7X	90	135	33.2	4.5	645	579	144
		180	34.0	6.1	845	758	138
		270	34.8	9.4	1210	1089	129
		405	35.6	14.4	1775	1579	123
		540	36.1	19.5	2274	2012	116
BXRE-30G1000-C-7X	90	180	33.2	6.0	858	765	143
		240	34.0	8.2	1124	998	138
		360	34.8	12.5	1613	1452	129
		540	35.6	19.2	2349	2040	122
BXRE-30G100C-B-73	90	720	36.1	26.0	3000	2568	115
		135	33.2	4.5	598	538	133
		180	34.0	6.1	784	704	128
		270	34.8	9.4	1123	1010	119
BXRE-30G100C-C-73	90	405	35.6	14.4	1647	1465	114
		540	36.1	19.5	2110	1868	108
		180	33.2	6.0	796	710	133
		240	34.0	8.2	1043	926	128
BXRE-30A1001-B-73	93	360	34.8	12.5	1497	1347	119
		540	35.6	19.2	2180	1893	113
		720	36.1	26.0	2784	2383	107
		135	33.2	4.5	581	522	130
BXRE-30A1001-C-73	93	180	34.0	6.1	762	683	124
		270	34.8	9.4	1090	981	116
		405	35.6	14.4	1599	1422	111
		540	36.1	19.5	2049	1813	105
BXRE-30H1000-B-7X	97	180	33.2	6.0	773	689	129
		240	34.0	8.2	1012	899	124
		360	34.8	12.5	1453	1308	116
		540	35.6	19.2	2116	1838	110
BXRE-30H1000-C-7X	97	720	36.1	26.0	2703	2314	104
		135	33.2	4.5	578	519	129
		180	34.0	6.1	757	679	124
		270	34.8	9.4	1084	976	115
BXRE-35E1000-B-7X	80	405	35.6	14.4	1590	1415	110
		540	36.1	19.5	2037	1803	104
		135	33.2	4.5	799	718	178
		180	34.0	6.1	1048	940	171
BXRE-35E1000-C-7X	80	270	34.8	9.4	1500	1350	160
		405	35.6	14.4	2201	1958	152
		540	36.1	19.5	2819	2495	144
		180	33.2	6.0	1063	949	178
BXRE-35E1000-C-7X	80	240	34.0	8.2	1393	1238	171
		360	34.8	12.5	2000	1800	160
		540	35.6	19.2	2912	2530	151
		720	36.1	26.0	3720	3185	143

Notes for Table 4:

1. Alternate drive currents are provided for reference only and are not a guarantee of performance.
2. Bridgelux maintains a ± 7% tolerance on flux measurements.
3. Typical stabilized DC performance values are provided as reference only and are not a guarantee of performance.

Performance at Commonly Used Drive Currents

Table 4: Product Performance at Commonly Used Drive Currents (Continued)

Part Number	CRI	Drive Current ¹ (mA)	Typical V _f T _c = 25°C (V)	Typical Power T _c = 25°C (W)	Typical Flux ² T _c = 25°C (lm)	Typical DC Flux ³ T _c = 85°C (lm)	Typical Efficacy T _c = 25°C (lm/W)
BXRE-35G1000-B-7X	90	135	33.2	4.5	665	598	148
		180	34.0	6.1	872	782	143
		270	34.8	9.4	1248	1124	133
		405	35.6	14.4	1832	1629	127
		540	36.1	19.5	2346	2077	120
BXRE-35G1000-C-7X	90	180	33.2	6.0	885	790	148
		240	34.0	8.2	1159	1030	142
		360	34.8	12.5	1665	1498	133
		540	35.6	19.2	2424	2106	126
		720	36.1	26.0	3096	2650	119
BXRE-35A1001-B-73	93	135	33.2	4.5	626	562	140
		180	34.0	6.1	821	736	134
		270	34.8	9.4	1175	1057	125
		405	35.6	14.4	1723	1533	119
		540	36.1	19.5	2207	1954	113
BXRE-35A1001-C-73	93	180	33.2	6.0	833	743	139
		240	34.0	8.2	1091	969	134
		360	34.8	12.5	1566	1409	125
		540	35.6	19.2	2280	1981	118
		720	36.1	26.0	2913	2493	112
BXRE-40E1000-B-7X	80	135	33.2	4.5	805	723	179
		180	34.0	6.1	1055	946	172
		270	34.8	9.4	1510	1359	161
		405	35.6	14.4	2215	1970	153
		540	36.1	19.5	2838	2511	145
BXRE-40E1000-C-7X	80	180	33.2	6.0	1070	955	179
		240	34.0	8.2	1402	1246	172
		360	34.8	12.5	2013	1812	161
		540	35.6	19.2	2931	2546	152
		720	36.1	26.0	3744	3205	144
BXRE-40G1000-B-7X	90	135	33.2	4.5	691	621	154
		180	34.0	6.1	906	813	148
		270	34.8	9.4	1297	1167	138
		405	35.6	14.4	1903	1692	132
		540	36.1	19.5	2437	2157	125
BXRE-40G1000-C-7X	90	180	33.2	6.0	919	820	154
		240	34.0	8.2	1204	1070	148
		360	34.8	12.5	1729	1556	138
		540	35.6	19.2	2518	2187	131
		720	36.1	26.0	3216	2753	124
BXRE-50C1001-B-7X	70	135	33.2	4.5	882	792	197
		180	34.0	6.1	1156	1037	189
		270	34.8	9.4	1655	1489	176
		405	35.6	14.4	2428	2160	168
		540	36.1	19.5	3110	2753	159

Notes for Table 4:

1. Alternate drive currents are provided for reference only and are not a guarantee of performance.
2. Bridgelux maintains a ± 7% tolerance on flux measurements.
3. Typical stabilized DC performance values are provided as reference only and are not a guarantee of performance.

Performance at Commonly Used Drive Currents

Table 4: Product Performance at Commonly Used Drive Currents (Continued)

Part Number	CRI	Drive Current ¹ (mA)	Typical V _f T _c = 25°C (V)	Typical Power T _c = 25°C (W)	Typical Flux ² T _c = 25°C (lm)	Typical DC Flux ³ T _c = 85°C (lm)	Typical Efficacy T _c = 25°C (lm/W)
BXRE-50C1001-C-7X	70	180	33.2	6.0	1173	1047	196
		240	34.0	8.2	1537	1365	188
		360	34.8	12.5	2207	1986	176
		540	35.6	19.2	3213	2791	167
		720	36.1	26.0	4104	3513	158
BXRE-50E1001-B-7X	80	135	33.2	4.5	830	746	185
		180	34.0	6.1	1089	976	178
		270	34.8	9.4	1558	1402	166
		405	35.6	14.4	2286	2033	158
		540	36.1	19.5	2929	2592	150
BXRE-50E1001-C-7X	80	180	33.2	6.0	1105	986	185
		240	34.0	8.2	1447	1286	177
		360	34.8	12.5	2078	1870	166
		540	35.6	19.2	3025	2628	157
		720	36.1	26.0	3864	3308	148
BXRE-50G1001-B-7X	90	135	33.2	4.5	701	630	156
		180	34.0	6.1	920	825	150
		270	34.8	9.4	1316	1185	140
		405	35.6	14.4	1931	1718	134
		540	36.1	19.5	2474	2189	127
BXRE-50G1001-C-7X	90	180	33.2	6.0	933	833	156
		240	34.0	8.2	1222	1086	150
		360	34.8	12.5	1755	1579	140
		540	35.6	19.2	2555	2220	133
		720	36.1	26.0	3264	2794	125
BXRE-57C1001-B-7X	70	135	33.2	4.5	851	765	190
		180	34.0	6.1	1116	1001	182
		270	34.8	9.4	1597	1437	170
		405	35.6	14.4	2343	2084	162
		540	36.1	19.5	3001	2656	154
BXRE-57C1001-C-7X	70	180	33.2	6.0	1132	1010	189
		240	34.0	8.2	1483	1317	182
		360	34.8	12.5	2129	1916	170
		540	35.6	19.2	3100	2693	161
		720	36.1	26.0	3960	3390	152
BXRE-57E1001-B-7X	80	135	33.2	4.5	821	738	183
		180	34.0	6.1	1077	966	176
		270	34.8	9.4	1541	1387	164
		405	35.6	14.4	2261	2011	157
		540	36.1	19.5	2896	2563	148
BXRE-57E1001-C-7X	80	180	33.2	6.0	1092	975	183
		240	34.0	8.2	1431	1271	175
		360	34.8	12.5	2055	1849	164
		540	35.6	19.2	2992	2599	155
		720	36.1	26.0	3822	3271	147

Notes for Table 4:

1. Alternate drive currents are provided for reference only and are not a guarantee of performance.
2. Bridgelux maintains a ± 7% tolerance on flux measurements.
3. Typical stabilized DC performance values are provided as reference only and are not a guarantee of performance.

Performance at Commonly Used Drive Currents

Table 4: Product Performance at Commonly Used Drive Currents (Continued)

Part Number	CRI	Drive Current ¹ (mA)	Typical V_f $T_c = 25^\circ\text{C}$ (V)	Typical Power $T_c = 25^\circ\text{C}$ (W)	Typical Flux ² $T_c = 25^\circ\text{C}$ (lm)	Typical DC Flux ³ $T_c = 85^\circ\text{C}$ (lm)	Typical Efficacy $T_c = 25^\circ\text{C}$ (lm/W)
BXRE-65C1001-B-7X	70	135	33.2	4.5	866	779	193
		180	34.0	6.1	1136	1019	186
		270	34.8	9.4	1626	1463	173
		405	35.6	14.4	2385	2122	165
		540	36.1	19.5	3056	2705	157
BXRE-65C1001-C-7X	70	180	33.2	6.0	1153	1028	193
		240	34.0	8.2	1510	1341	185
		360	34.8	12.5	2168	1951	173
		540	35.6	19.2	3157	2742	164
BXRE-65E1001-B-7X	80	135	33.2	4.5	836	751	186
		180	34.0	6.1	1096	983	179
		270	34.8	9.4	1569	1412	167
		405	35.6	14.4	2302	2048	160
BXRE-65E1001-C-7X	80	540	36.1	19.5	2949	2610	151
		180	33.2	6.0	1112	993	186
		240	34.0	8.2	1457	1295	179
		360	34.8	12.5	2092	1883	167
		540	35.6	19.2	3047	2647	158
		720	36.1	26.0	3892	3331	150

Notes for Table 4:

1. Alternate drive currents are provided for reference only and are not a guarantee of performance.
2. Bridgelux maintains a $\pm 7\%$ tolerance on flux measurements.
3. Typical stabilized DC performance values are provided as reference only and are not a guarantee of performance.

Electrical Characteristics

Table 5: Electrical Characteristics

Part Number	Drive Current (mA)	Forward Voltage Pulsed, $T_c = 25^\circ\text{C}$ (V) ^{1, 2, 3, 8}			Typical Coefficient of Forward Voltage ⁴ $\Delta V_f / \Delta T_c$ (mV/ $^\circ\text{C}$)	Typical Thermal Resistance Junction to Case ^{5,6} R_{j-c} ($^\circ\text{C}/\text{W}$)	Driver Selection Voltages ⁷ (V)	
		Minimum	Typical	Maximum			V_f Min. Hot $T_c = 105^\circ\text{C}$ (V)	V_f Max. Cold $T_c = -40^\circ\text{C}$ (V)
BXRE-xxx100x-B-7x	270	32.2	34.8	37.4	-16.1	0.49	30.9	38.5
	540	33.4	36.1	38.8	-16.1	0.56	32.1	39.9
BXRE-xxx100x-C-7x	360	32.2	34.8	37.4	-16.1	0.37	30.9	38.5
	720	33.4	36.1	38.8	-16.1	0.45	32.1	39.9

Notes for Table 5:

- Parts are tested in pulsed conditions. $T_c = 25^\circ\text{C}$. Pulse width is 10ms.
- Voltage minimum and maximum are provided for reference only and are not a guarantee of performance.
- Bridgelux maintains a tester tolerance of $\pm 0.10\text{V}$ on forward voltage measurements.
- Typical coefficient of forward voltage tolerance is $\pm 0.1\text{mV}$ for nominal current.
- Thermal resistance values are based from test data of a 3000K 80 CRI product.
- Thermal resistance value was calculated using total electrical input power; optical power was not subtracted from input power. The thermal interface material used during testing is not included in the thermal resistance value.
- V_f min hot and max cold values are provided as reference only and are not guaranteed by test. These values are provided to aid in driver design and selection over the operating range of the product.
- This product has been designed and manufactured per IEC 62031:2014. This product has passed dielectric withstand voltage testing at 1160 V. The working voltage designated for the insulation is 80V d.c. The maximum allowable voltage across the array must be determined in the end product application.

Eye Safety

Table 6: Eye Safety Risk Group (RG) Classifications

Part Number	Drive Current ⁵ (mA)	CCT ¹⁻⁵			
		2700K/3000K	4000K ²	5000K ³	6500K ⁴
BXRE-xxx100x-B-7x	270	RG1	RG1	RG1	RG1
	405	RG1	RG1	RG1	RG2
	540	RG1	RG1	RG2	RG2
BXRE-xxx100x-C-7x	360	RG1	RG1	RG1	RG2
	540	RG1	RG1	RG2	RG2
	720	RG1	RG2	RG2	RG2

Notes for Table 6:

1. Eye safety classification for the use of Bridgelux V Series LED arrays is in accordance with specification IEC/TR 62778: Application of IEC 62471 for the assessment of blue light hazard to light sources and luminaires.
2. For products classified as RG2 at 4000K, $E_{thr} = 1847.5$ lx.
3. For products classified as RG2 at 5000K, $E_{thr} = 1315.8$ lx.
4. For products classified as RG2 at 6500K, $E_{thr} = 1124.5$ lx.
5. Please contact your Bridgelux sales representative for E_{thr} values at specific drive currents and CCTs not listed.

Absolute Maximum Ratings

Table 7: Maximum Ratings

Parameter	Maximum Rating	
LED Junction Temperature (T _j)	125°C	
Storage Temperature	-40°C to +105°C	
Operating Case Temperature ¹ (T _c)	105°C	
Soldering Temperature ²	300°C or lower for a maximum of 6 seconds	
	BXRE-xxx100x-B-7x	BXRE-xxx100x-C-7x
Maximum Drive Current ³	540mA	720mA
Maximum Peak Pulsed Drive Current ⁴	770mA	1030mA
Maximum Reverse Voltage ⁵	-60V	-60V

Notes for Table 7:

1. For IEC 62717 requirement, please consult your Bridgelux sales representative.
2. Refer to Bridgelux Application Note AN101: Handling and Assembly of Bridgelux V Series LED Arrays.
3. Arrays may be driven at higher currents however lumen maintenance may be reduced.
4. Bridgelux recommends a maximum duty cycle of 10% and pulse width of 20 ms when operating LED Arrays at maximum peak pulsed current specified. Maximum peak pulsed currents indicate values where LED Arrays can be driven without catastrophic failures.
5. Light emitting diodes are not designed to be driven in reverse voltage and will not produce light under this condition. Maximum rating provided for reference only.

Performance Curves

Figure 1: V10B Drive Current vs. Voltage

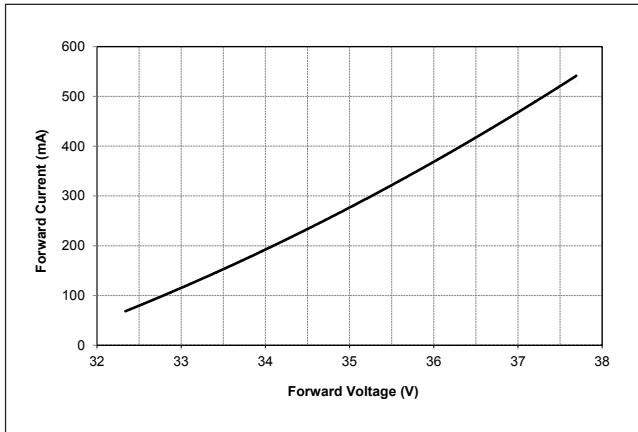

Figure 2: V10C Drive Current vs. Voltage

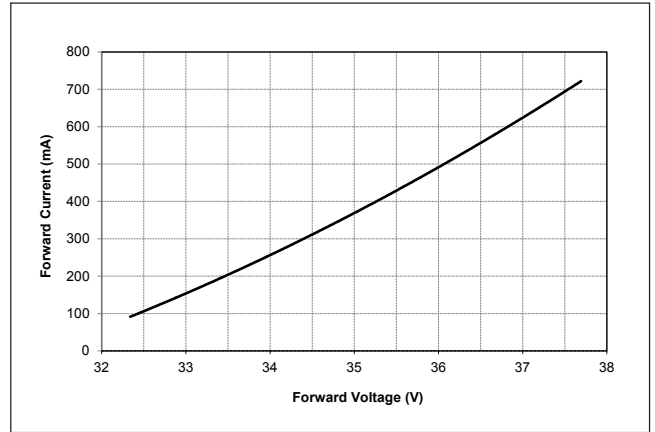

Figure 3: V10B Typical Relative Flux vs. Current

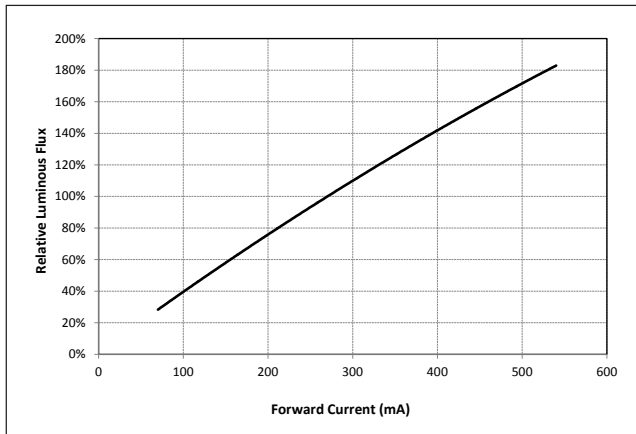
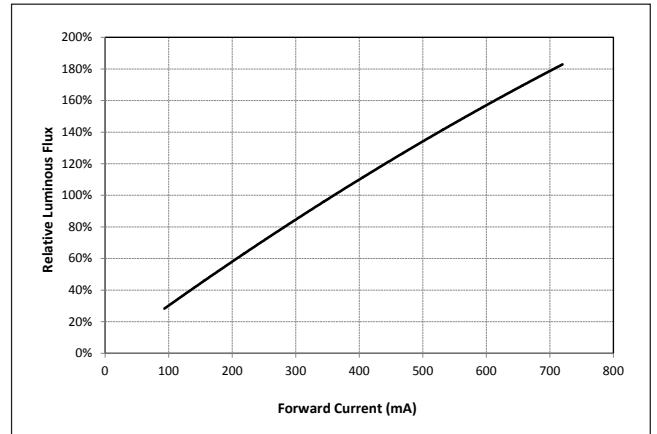

Figure 4: V10C Typical Relative Flux vs. Current



Notes for Figures 1-4:

1. Bridgelux does not recommend driving high power LEDs at low currents. Doing so may produce unpredictable results. Pulse width modulation (PWM) is recommended for dimming effects.
2. Products tested under pulsed condition (10ms pulse width) at nominal test current where T_j (junction temperature) = T_c (case temperature) = 25°C.

Performance Curves

Figure 5: Typical DC Flux vs. Case Temperature⁵

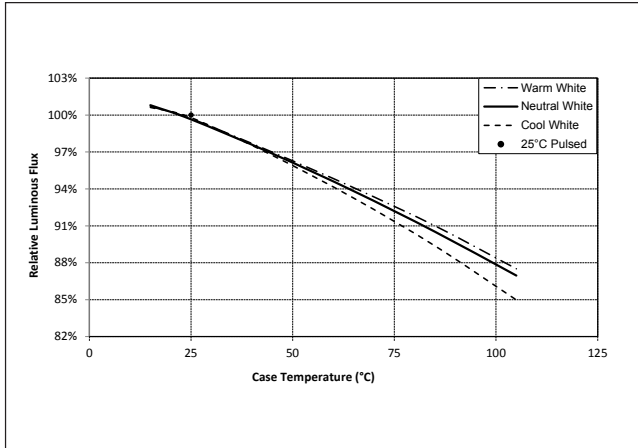

Figure 6: Typical DC ccy Shift vs. Case Temperature

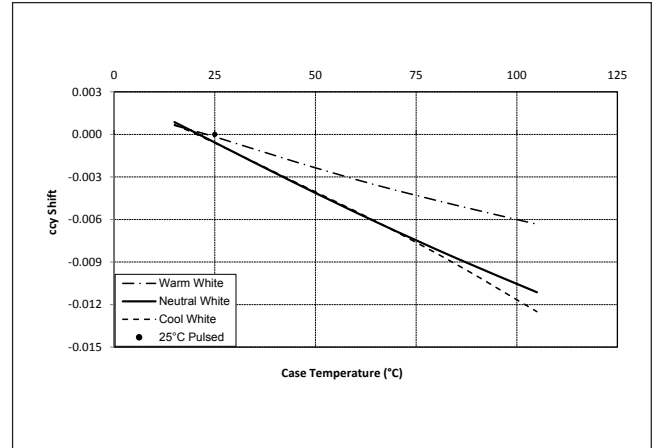
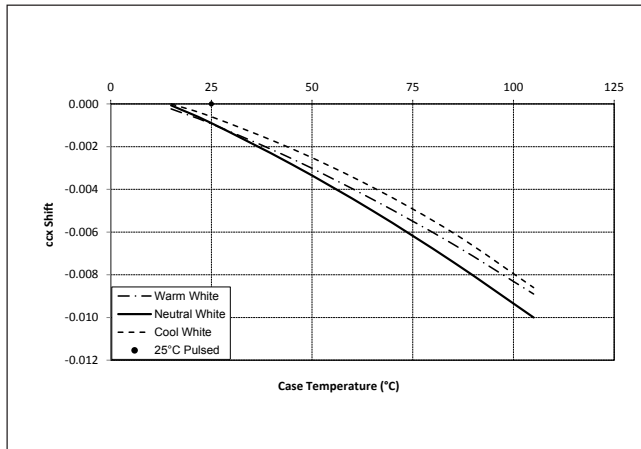

Figure 7: Typical DC ccx Shift vs. Case Temperature



Notes for Figures 5-7:

1. Characteristics shown for warm white based on 3000K and 80 CRI.
2. Characteristics shown for neutral white based on 4000K and 80 CRI.
3. Characteristics shown for cool white based on 5000K and 70 CRI.
4. Characteristics shown for warm white includes Decor Series Class A
5. For other color SKUs, the shift in color will vary. Please contact your Bridgelux Sales Representative for more information.

Performance Curves

Figure 8: 2000K, 65 CRI Color Shift vs. Case Temperature

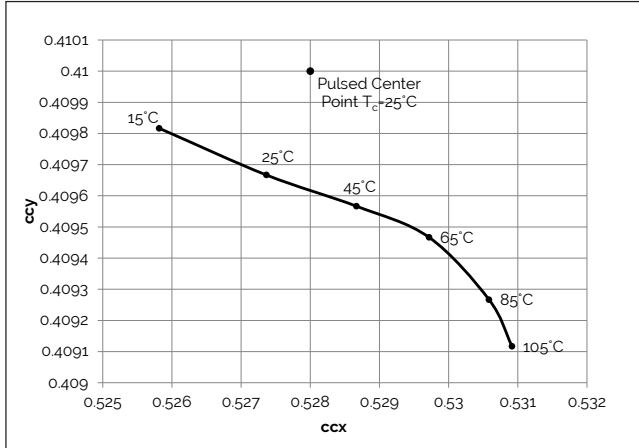

Figure 9: 3000K, 90 CRI Color Shift vs. Case Temperature^{1,3}

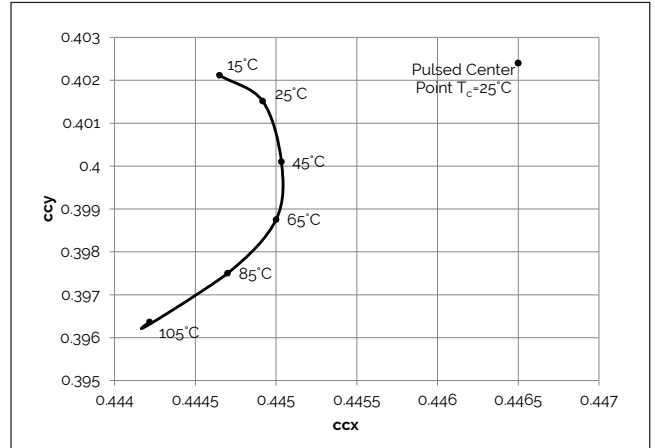

Figure 10: 2700K, 97 CRI Color Shift vs. Case Temperature¹

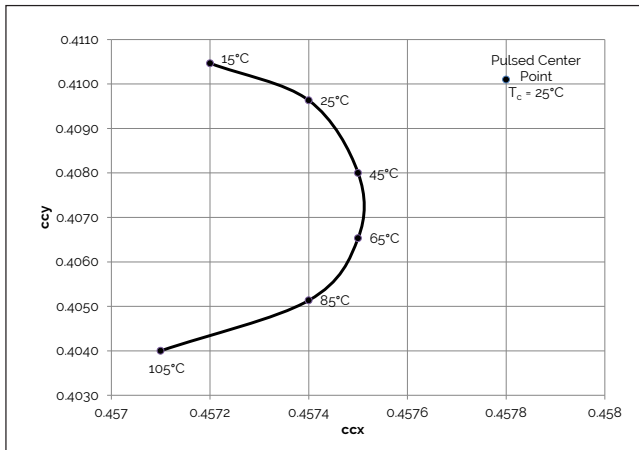

Figure 11: 3000K, 97 CRI Color Shift vs. Case Temperature¹

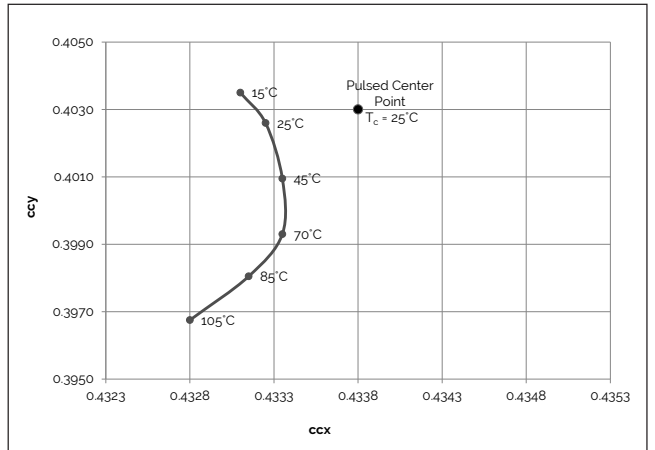

Figure 12: 3000K Class A Color Shift vs. Case Temperature¹

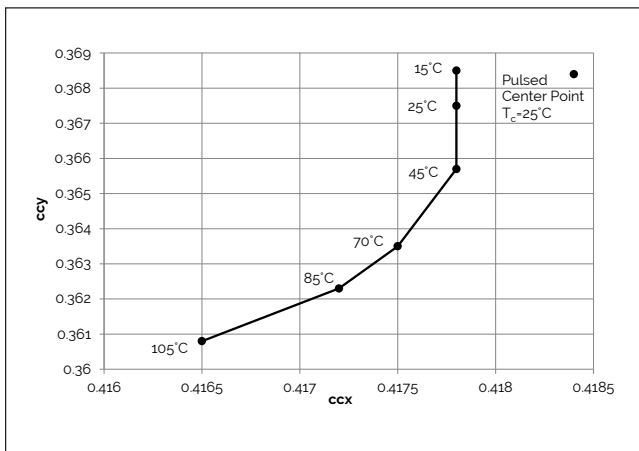
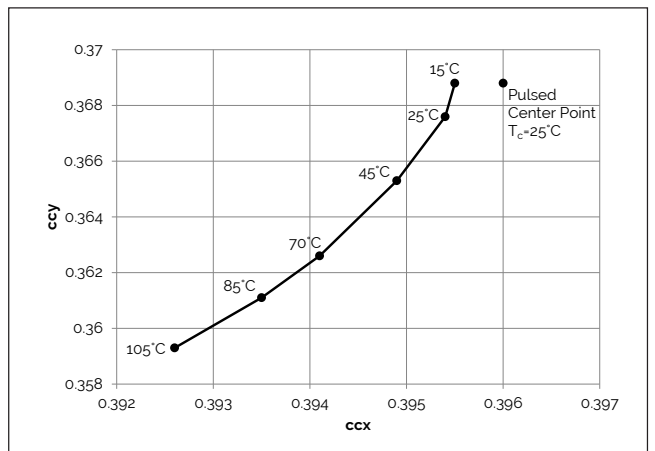

Figure 13: 3500K Class A Color Shift vs. Case Temperature¹



Note for Figures 8-13:

1. Measurements made under DC test conditions at the nominal drive current.
2. Typical color shift is shown with a tolerance of ± 0.002 .
3. Characteristics shown for Decor Series Showcase products, BXRE-30G100C-x-73

Typical Radiation Pattern

Figure 14: Typical Spatial Radiation Pattern

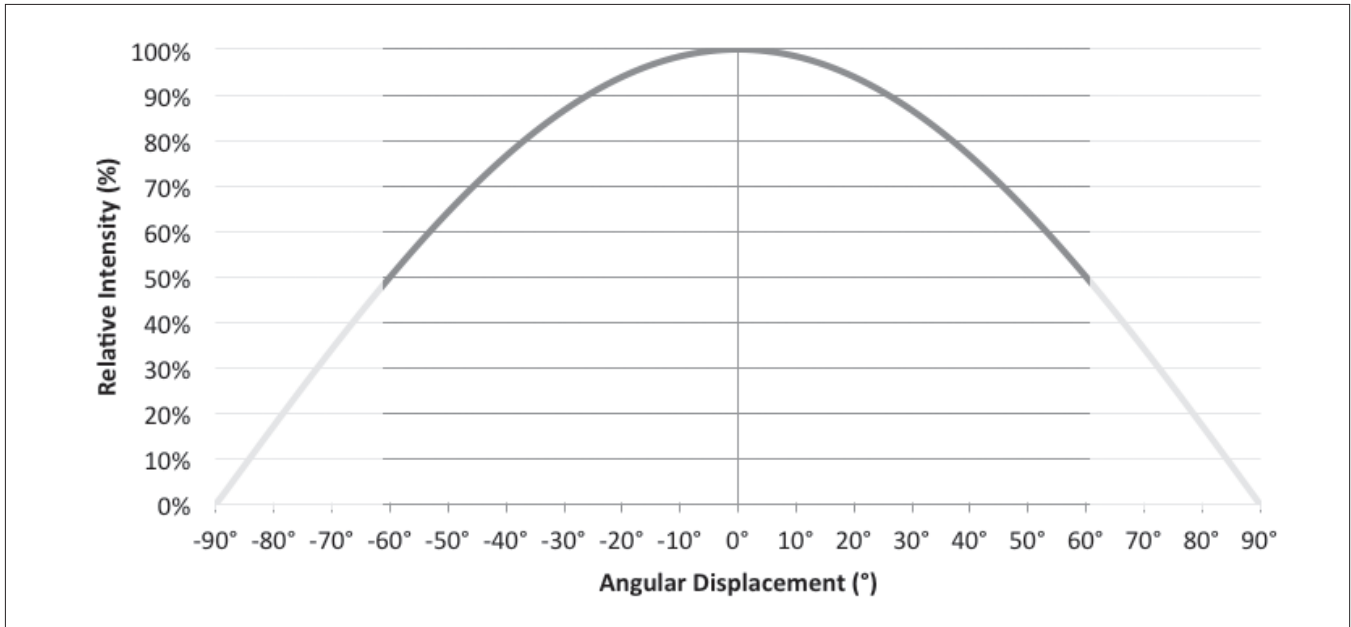

Note for Figure 14:

1. Typical viewing angle is 120°.
2. The viewing angle is defined as the off axis angle from the centerline where intensity is ½ of the peak value.

Figure 15: Typical Polar Radiation Pattern

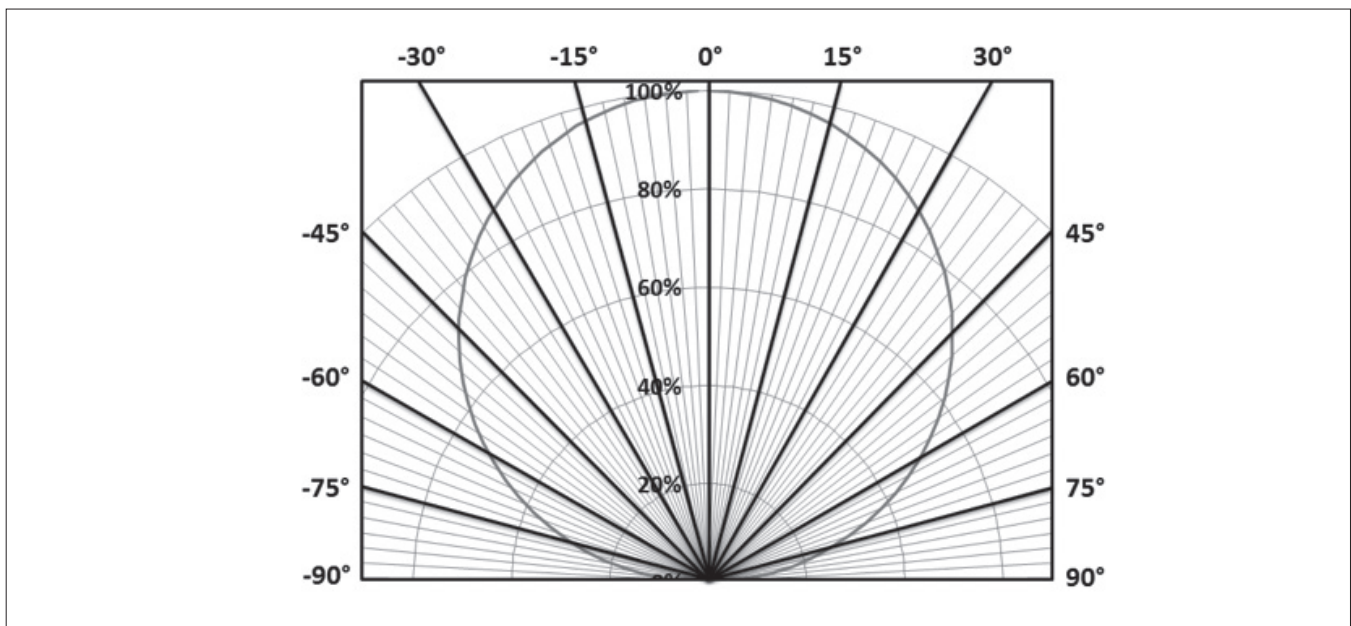

Typical Color Spectrum

Figure 16: Typical Color Spectrum

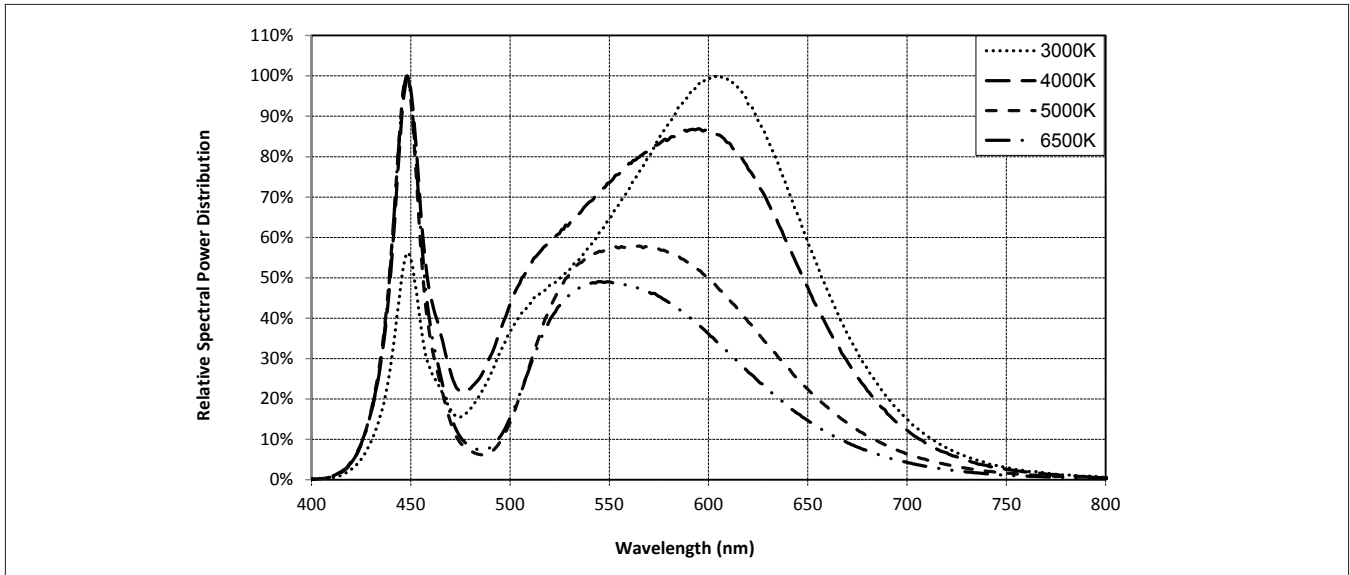

Note for Figure 16:

1. Color spectra measured at nominal current for $T_j = T_c = 25^\circ\text{C}$.
2. Color spectra shown is 3000K and 80 CRI.
3. Color spectra shown is 4000K and 80 CRI.
4. Color spectra shown is 5000K and 70 CRI.
4. Color spectra shown is 6500K and 70 CRI.

Figure 17: Typical Color Spectrum for Décor Series

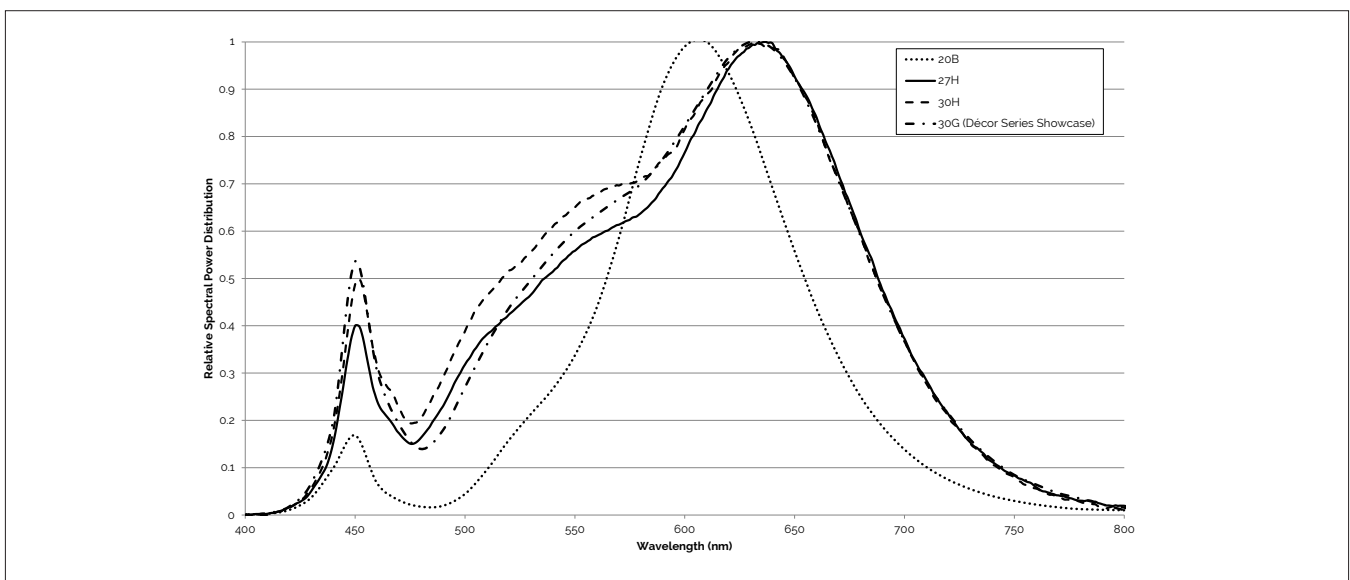

Note for Figure 17:

1. Color spectra measured at nominal current for $T_j = T_c = 25^\circ\text{C}$.

Mechanical Dimensions

Figure 18: Drawing for V10 LED Array

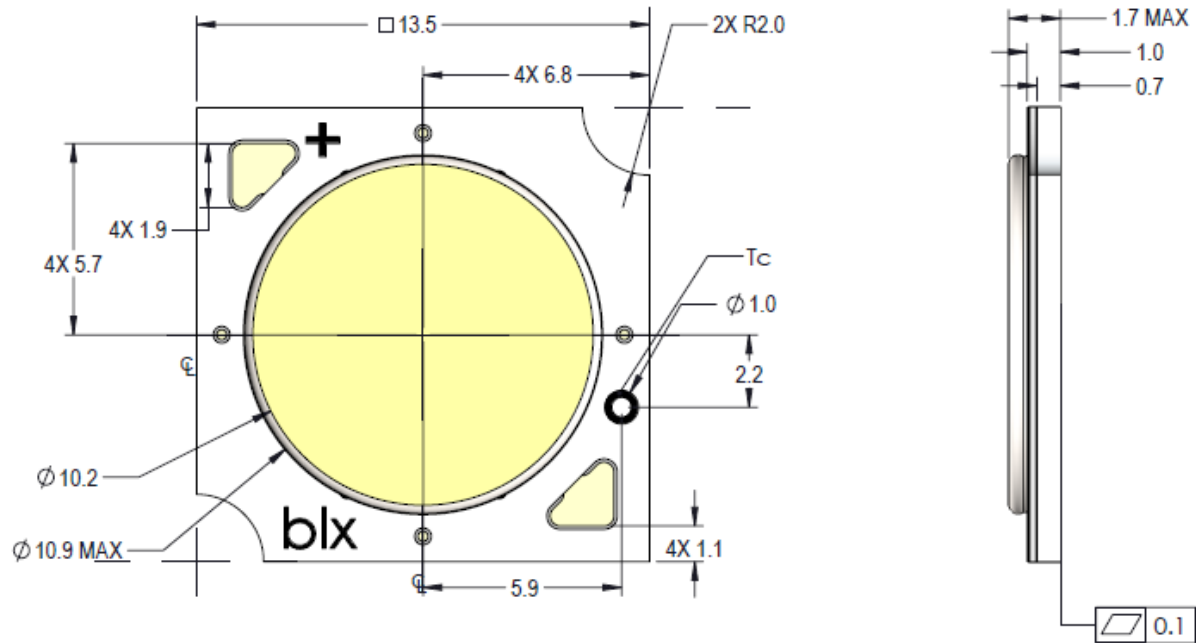

Notes for Figure 18:

1. Drawings are not to scale.
2. Drawing dimensions are in millimeters.
3. Unless otherwise specified, tolerances are $\pm 0.1\text{mm}$.
4. Solder pad labeled "+" denotes positive contact.
5. Refer to Application Notes AN101 for product handling, mounting and heat sink recommendations.
6. The optical center of the LED Array is nominally defined by the mechanical center of the array to a tolerance of $\pm 0.2\text{mm}$.
7. Bridgelux maintains a flatness of 0.10mm across the mounting surface of the array.

Color Binning Information

Figure 19: Warm and Neutral White Test Bins in xy Color Space

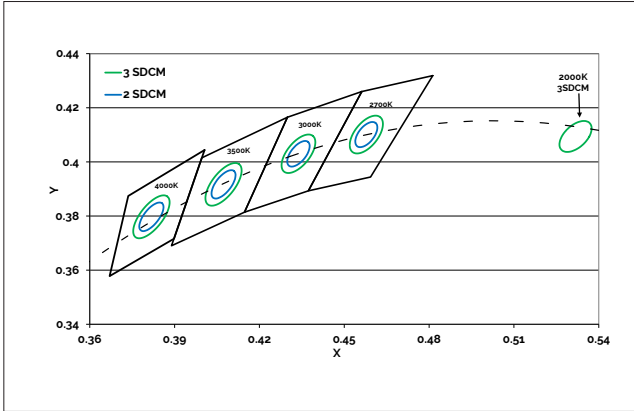

Note: Pulsed Test Conditions, $T_c = 25^\circ\text{C}$

Figure 20: Cool White Test Bins in xy Color Space

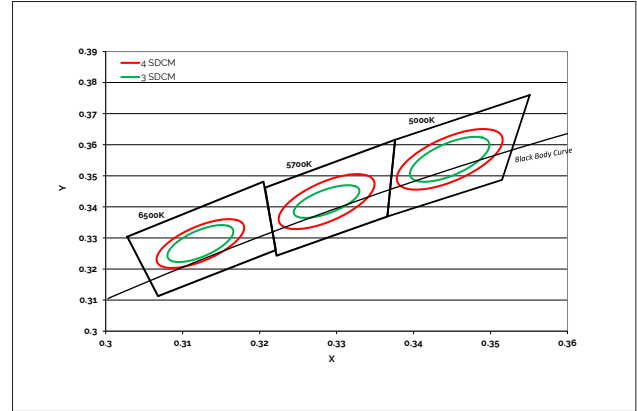

Note: Pulsed Test Conditions, $T_c = 25^\circ\text{C}$

Table 8: Warm and Neutral White xy Bin Coordinates and Associated Typical CCT

Bin Code	2000K	2700K	3000K ¹	3500K ¹	4000K ¹
ANSI Bin (for reference only)	-	(2580K - 2870K)	(2870K - 3220K)	(3220K - 3710K)	(3710K - 4260K)
73 (3 SDCM)	-	(2651K - 2794K)	(2968K - 3136K)	(3369K - 3586K)	(3851K - 4130K)
72 (2 SDCM)	-	(2674K - 2769K)	(2995K - 3107K)	(3404K - 3548K)	(3895K - 4081K)
Center Point (x,y)	(0.5280, 0.4100)	(0.4578, 0.4101)	(0.4338, 0.403) (0.4465, 0.4024) ²	(0.4073, 0.3917)	(0.3818, 0.3797)

Note for Table 8:

- Color Binning information excludes Décor Series Class A products. Please contact your Bridgelux Sales Representative for more information.
- Center Point for Décor Series Showcase.

Table 9: Cool White xy Bin Coordinates and Associated Typical CCT (product is hot targeted to $T_c = 85^\circ\text{C}$)

Bin Code	5000K	5700K	6500K
ANSI Bin (for reference only)	(4745K - 5311K)	(5312K - 6022K)	(6022K - 7042K)
74 (4 SDCM)	(4801K - 5282K)	(5481K - 5829K)	(6270K - 6765K)
73 (3 SDCM)	(4835K - 5215K)	(5490K - 5820K)	(6250K - 6745K)
Center Point (x,y)	(0.3447, 0.3553)	(0.3287, 0.3417)	(0.3123, 0.3282)

Packaging and Labeling

Figure 21: V10 Packaging Tube

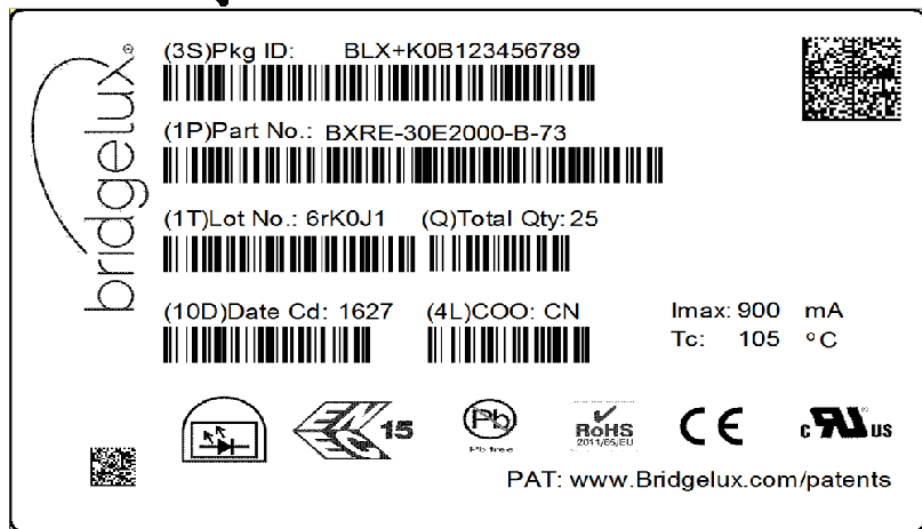

Box Label

Commercial Invoice
and Packing list



Notes for Figure 21:

1. Each tube holds 30 V10 COB arrays.
2. One tube is sealed in an anti-static bag. Four bags are placed in a shipping box. Depending on quantities ordered, a bigger shipping box, containing four boxes may be used to ship products.
3. Each bag and box is to be labeled as shown above.
4. Dimensions for each tube are 8.3 (W) x 15.4 (H) x 430 (L). Dimensions for the anti-static bag are 75 (W) x 615 (L) x 3.1 (T) mm. Dimensions for the shipping box are 58.7 x 13.3 x 7.9 cm

Packaging and Labeling

Figure 22: Gen. 7 Product Labeling

Bridgelux COB arrays have laser markings on the back side of the substrate to help with product identification. In addition to the product identification markings, Bridgelux COB arrays also contain markings for internal Bridgelux manufacturing use only. The image below shows which markings are for customer use and which ones are for Bridgelux internal use only. The Bridgelux internal manufacturing markings are subject to change without notice, however these will not impact the form, function or performance of the COB array.



Design Resources

Application Notes

Bridgelux has developed a comprehensive set of application notes and design resources to assist customers in successfully designing with the V Series product family of LED array products. For all available application notes visit www.bridgelux.com.

Optical Source Models

Optical source models and ray set files are available for all Bridgelux products. For a list of available formats, visit www.bridgelux.com.

3D CAD Models

Three dimensional CAD models depicting the product outline of all Bridgelux V Series LED arrays are available in both IGS and STEP formats. Please contact your Bridgelux sales representative for assistance.

LM80

LM80 testing has been completed and the LM80 report is now available. Please contact your Bridgelux sales representative for LM-80 report.

Precautions

CAUTION: CHEMICAL EXPOSURE HAZARD

Exposure to some chemicals commonly used in luminaire manufacturing and assembly can cause damage to the LED array. Please consult Bridgelux Application Note AN101 for additional information.

CAUTION: RISK OF BURN

Do not touch the V Series LED array during operation. Allow the array to cool for a sufficient period of time before handling. The V Series LED array may reach elevated temperatures such that could burn skin when touched.

CAUTION

CONTACT WITH LIGHT EMITTING SURFACE (LES)

Avoid any contact with the LES. Do not touch the LES of the LED array or apply stress to the LES (yellow phosphor resin area). Contact may cause damage to the LED array.

Optics and reflectors must not be mounted in contact with the LES (yellow phosphor resin area).

Disclaimers

MINOR PRODUCT CHANGE POLICY

The rigorous qualification testing on products offered by Bridgelux provides performance assurance. Slight cosmetic changes that do not affect form, fit, or function may occur as Bridgelux continues product optimization.

STANDARD TEST CONDITIONS

Unless otherwise stated, array testing is performed at the nominal drive current.

About Bridgelux: We Build Light That Transforms

At Bridgelux, we help companies, industries and people experience the power and possibility of light. Since 2002, we've designed LED solutions that are high performing, energy efficient, cost effective and easy to integrate. Our focus is on light's impact on human behavior, delivering products that create better environments, experiences and returns—both experiential and financial. And our patented technology drives new platforms for commercial and industrial luminaires.

For more information about the company, please visit
bridgelux.com
twitter.com/Bridgelux
facebook.com/Bridgelux
youtube.com/user/Bridgelux
linkedin.com/company/bridgelux-inc-_2
WeChat ID: BridgeluxInChina



46430 Fremont Boulevard
Fremont, CA 94538
Tel (925) 583-8400
www.bridgelux.com

© 2016-2017 Bridgelux, Inc. All rights reserved 2016-2017. Product specifications are subject to change without notice. Bridgelux, the Bridgelux stylized logo design and Vero are registered trademarks, and Decor Series is a trademark of Bridgelux, Inc. All other trademarks are the property of their respective owners.

Bridgelux Gen 7 V10 Array Series Product Data Sheet DS100 Rev. K (12/2017)