

# Sensor/Actuator cable - SAC-5P-M12MS/0,3-600/M12FS FB - 1404097

Please be informed that the data shown in this PDF Document is generated from our Online Catalog. Please find the complete data in the user's documentation. Our General Terms of Use for Downloads are valid (<http://download.phoenixcontact.com>)



Sensor/Actuator cable, 5-position, PP-EPDM halogen-free, Gray RAL 7035, Plug straight M12, A-coded, on Socket straight M12, A-coded, Cable length: 0.3 m, Hygienic design, with plastic knurl



## Key commercial data

Packing unit	0
Minimum order quantity	1
GTIN	 4 046356 676519
Custom tariff number	85444290
Country of origin	POLAND

## Technical data

### General data

Rated current at 40°C	4 A
Rated voltage	60 V
Number of positions	5
Volume resistance	≤ 5 mΩ
Insulation resistance	≥ 100 MΩ
Length of cable	0.3 m
Ambient temperature (operation)	-40 °C ... 105 °C (Male connector / female connector)

### General characteristics

Standards/regulations	M12 plug-in connector IEC 61076-2-101
Coding	A - standard
Surge voltage category	II
Pollution degree	3
Degree of protection	IP65/IP68/IP69K
Insertion/withdrawal cycles	≥ 100
Torque	0.4 Nm (M12 plug-in connector)
Contact material	CuSn

# Sensor/Actuator cable - SAC-5P-M12MS/0,3-600/M12FS FB - 1404097

## Technical data

### General characteristics

Contact surface material	Ni/Au
Contact carrier material	PP
Material of grip body	PP
Material, knurls	PP
Sealing material	FKM
Status display	No

### Conductor data

Cable type	Halogen-free PP gray
Cable type (abbreviation)	600
Cable abbreviation	Li9Y9Y
Conductor cross section	5x 0.34 mm <sup>2</sup> (signal line)
AWG signal line	22
Conductor structure signal line	42x 0.10 mm
Core diameter including insulation	1.27 mm ±0.02 mm (signal line)
Thickness, insulation	≥ 0.21 mm (Core insulation)
Wire colors	Brown, white, blue, black, gray
Overall twist	5 cores, twisted
Length of twist, overall twist	55 mm
External sheath, color	Gray RAL 7035
Outer sheath thickness	Approx. 0.7 mm
External cable diameter D	5 mm ±0.15 mm
Minimum bending radius, fixed installation	5 x D
Minimum bending radius, flexible installation	10 x D
Cable weight	34 kg/km
Outer sheath, material	PP-EPDM
Material conductor insulation	PP
Conductor material	Bare Cu litz wires
Conductor resistance	58 Ω/km (At an ambient temperature of 20°C)
Nominal voltage, conductor	≤ 300 V AC
Test voltage, conductor	≥ 3000 V AC
Special properties	FDA compliant
Halogen-free	in accordance with DIN VDE 0472 part 815
Ambient temperature (operation)	-40 °C ... 105 °C (cable, fixed installation)

## Classifications

### ETIM

ETIM 3.0	EC001855
ETIM 4.0	EC001855
ETIM 5.0	EC001855

# Sensor/Actuator cable - SAC-5P-M12MS/0,3-600/M12FS FB - 1404097

## Classifications

### UNSPSC

UNSPSC 11	31251501
UNSPSC 12.01	31251501
UNSPSC 13.2	31251501
UNSPSC 6.01	31251501
UNSPSC 7.0901	31251501

### eCl@ss

eCl@ss 4.0	27060306
eCl@ss 4.1	27060306
eCl@ss 5.0	27061801
eCl@ss 5.1	27061801
eCl@ss 6.0	27061801
eCl@ss 7.0	27061801

## Drawings

### Schematic diagram

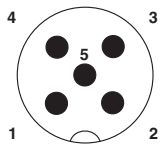

Pin assignment M12 male connector, 5-pos., A-coded, male side

### Schematic diagram

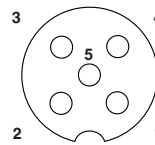

Pin assignment M12 socket, 5-pos., A-coded, socket side view

### Cable cross section

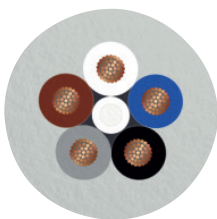

Halogen-free PP gray [600]

### Circuit diagram

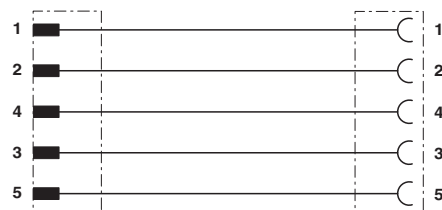

Contact assignment of the M12 connector and the M12 socket

# Sensor/Actuator cable - SAC-5P-M12MS/0,3-600/M12FS FB - 1404097

Dimensioned drawing

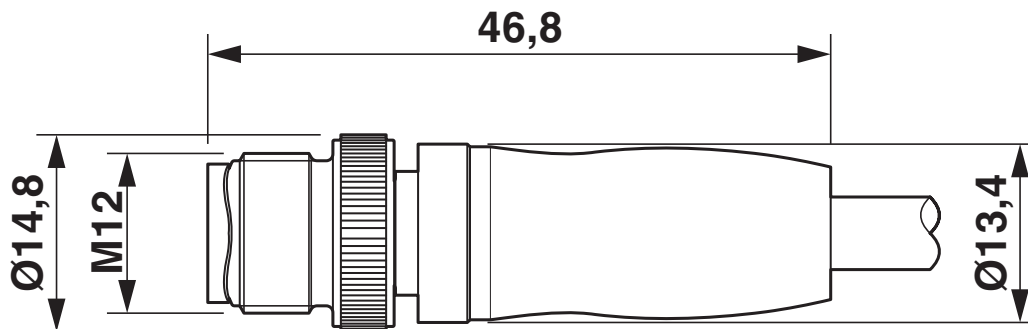

# Sensor/Actuator cable - SAC-5P-M12MS/0,3-600/M12FS FB - 1404097

Dimensioned drawing

