

PACKAGE TOP VIEW

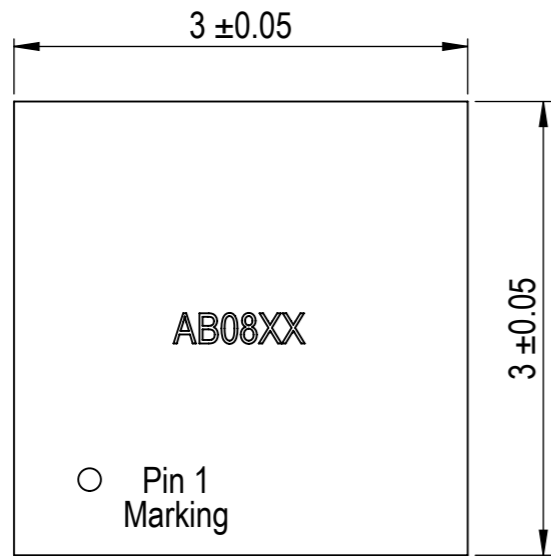

EXAMPLE PCB LAND PATTERN

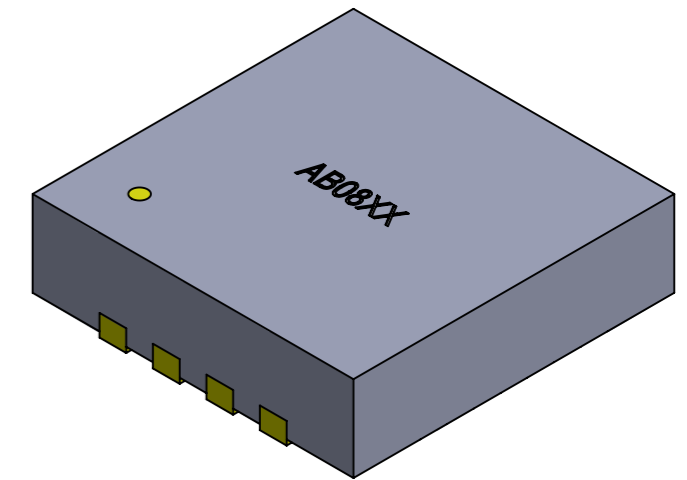
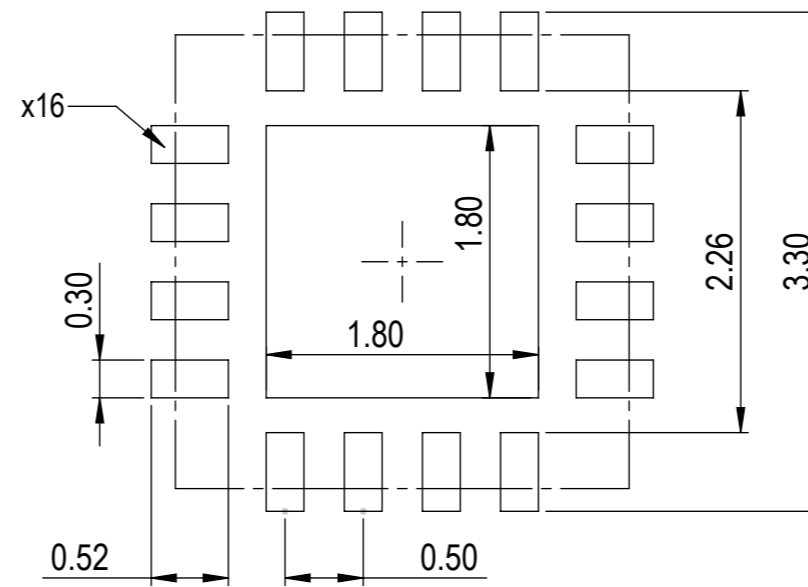

PACKAGE SIDE VIEW

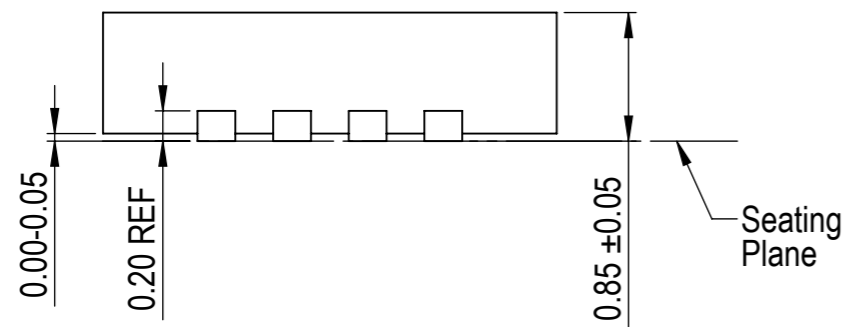

EXAMPLE SOLDER STENCIL

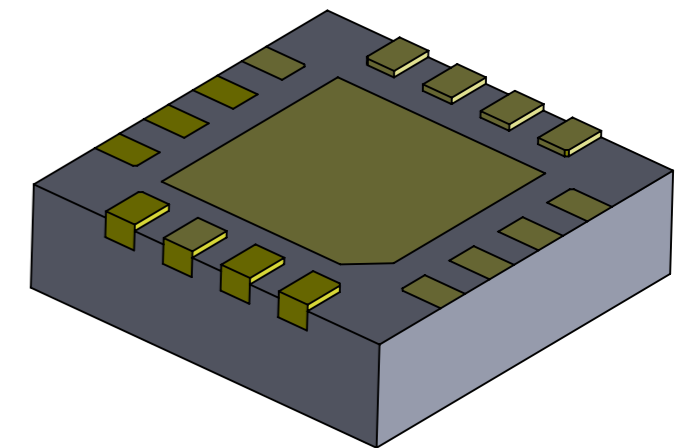
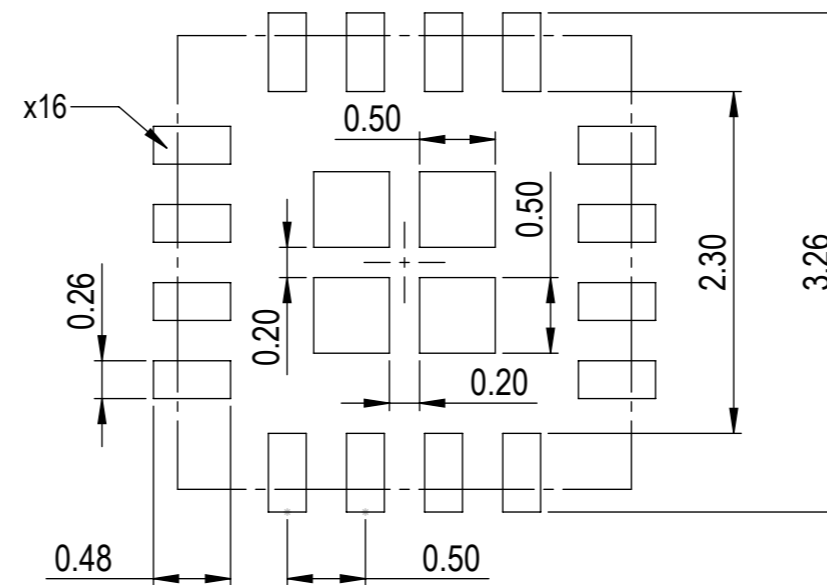

PACKAGE BOTTOM VIEW

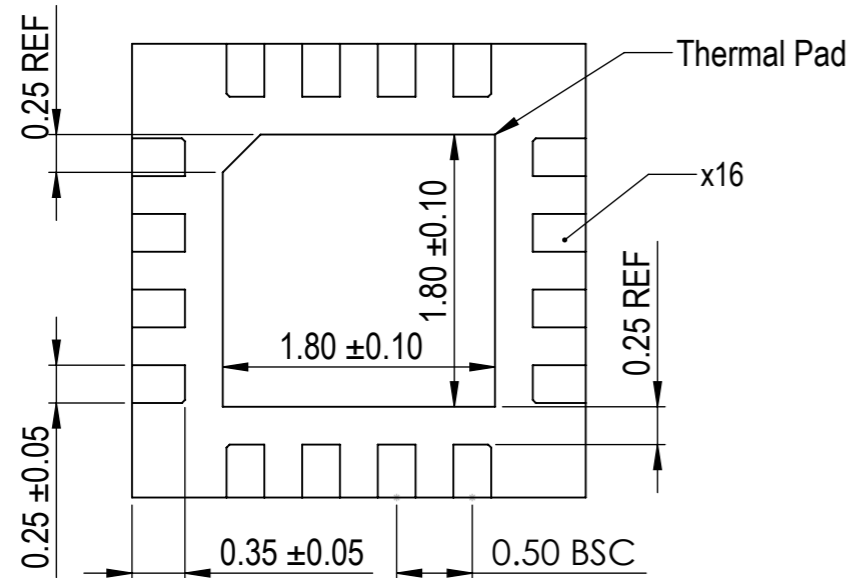

|  |  |  |  |           |                                   |  |          |
|--|--|--|--|-----------|-----------------------------------|--|----------|
| UNLESS OTHERWISE SPECIFIED:<br>DIMENSIONS ARE IN MM<br>SURFACE FINISH:<br>TOLERANCES:<br>LINEAR:<br>ANGULAR: |  |  |  | FINISH:   | DEBUR AND<br>BREAK SHARP<br>EDGES | DO NOT SCALE DRAWING   | REVISION |
| DRAWN XXXXXX   |  |  |  | SIGNATURE | DATE                              | <br>30332 Esperanza, Rancho Santa margarita, California 92688 |          |
| CHK'D XXXXXX   |  |  |  |           |                                   | TITLE: AB08XX Series<br>Ultra Low Power RTC IC; User's Guide   |          |
| APP'V'D  |  |  |  |           |                                   | DWG NO. AB08XX   |          |
| MFG  |  |  |  |           |                                   | SCALE: 20:1  |          |
| Q.A  |  |  |  | MATERIAL: |                                   | SHEET 1 OF 1   |          |
|  |  |  |  | WEIGHT:   |                                   | A3   |          |