

Base strip - MCV 1,5/ 2-GF-3,5 THT-R32 - 1996799

Please be informed that the data shown in this PDF Document is generated from our Online Catalog. Please find the complete data in the user's documentation. Our General Terms of Use for Downloads are valid (<http://phoenixcontact.com/download>)



Header, Nominal current: 8 A, Rated voltage (III/2): 160 V, Number of positions: 2, Pitch: 3.5 mm, Color: black, Contact surface: Tin, Assembly: Taped SMD/THT/THR components, User information and design recommendations for through hole reflow technology can be found under "Downloads"



Key commercial data

Packing unit	1 pc
Minimum order quantity	200 pc
Custom tariff number	85366990
Country of origin	Germany

Technical data

Dimensions

Length	7.25 mm
Pitch	3.5 mm
Dimension a	3.5 mm
Pin dimensions	0,8 x 0,8 mm
Hole diameter	1.4 mm

General

Range of articles	MCV 1,5/..-GF-THT
Insulating material group	IIIa
Rated surge voltage (III/3)	2.5 kV
Rated surge voltage (III/2)	2.5 kV
Rated surge voltage (II/2)	2.5 kV
Rated voltage (III/3)	160 V
Rated voltage (III/2)	160 V
Rated voltage (II/2)	320 V
Connection in acc. with standard	EN-VDE

Base strip - MCV 1,5/ 2-GF-3,5 THT-R32 - 1996799

Technical data

General

Nominal current I_N	8 A
Maximum load current	8 A (per position)
Insulating material	PA-GF
Inflammability class according to UL 94	V0
Color	black
Number of positions	2

Classifications

eCl@ss

eCl@ss 4.0	272607xx
eCl@ss 4.1	27260701
eCl@ss 5.0	27260701
eCl@ss 5.1	27260701
eCl@ss 6.0	27260704

ETIM

ETIM 3.0	EC001121
ETIM 4.0	EC002637
ETIM 5.0	EC002637

UNSPSC

UNSPSC 6.01	30211810
UNSPSC 7.0901	39121409
UNSPSC 11	39121409
UNSPSC 12.01	39121409
UNSPSC 13.2	39121409

Approvals

Approvals

Approvals

UL Recognized / VDE Gutachten mit Fertigungsüberwachung / cUL Recognized / IECCEB Scheme / GOST / GOST / CCA / cULus Recognized

Ex Approvals

Base strip - MCV 1,5/ 2-GF-3,5 THT-R32 - 1996799

Approvals

Approvals submitted

Approval details

UL Recognized 		
	B	D
Nominal current IN	8 A	8 A
Nominal voltage UN	300 V	300 V

VDE Gutachten mit Fertigungsüberwachung 	
Nominal current IN	8 A
Nominal voltage UN	160 V

cUL Recognized 		
	B	D
Nominal current IN	8 A	8 A
Nominal voltage UN	300 V	300 V

IECEE CB Scheme 	
Nominal current IN	8 A
Nominal voltage UN	160 V

GOST 
--

Base strip - MCV 1,5/ 2-GF-3,5 THT-R32 - 1996799

Approvals

GOST

CCA

Nominal current I _N	8 A
Nominal voltage U _N	160 V

cULus Recognized

Drawings

Dimensioned drawing

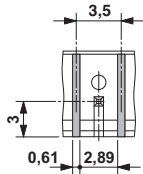

Drilling diagram

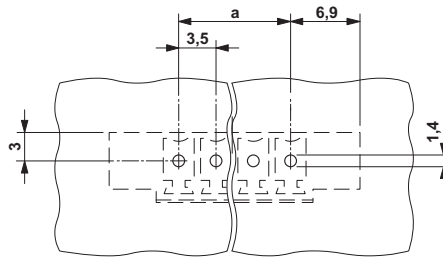

Dimensioned drawing

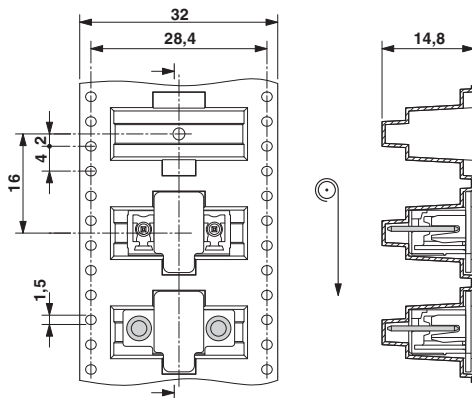

Dimensioned drawing

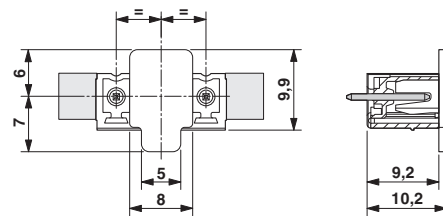

Base strip - MCV 1,5/ 2-GF-3,5 THT-R32 - 1996799

Dimensioned drawing

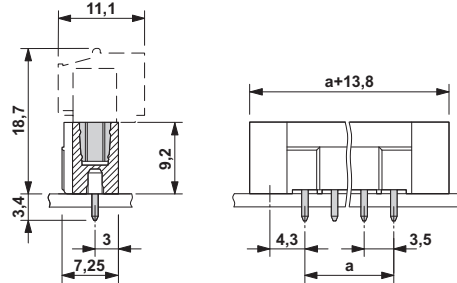

Dimensioned drawing

