

### 48 V - 130 W high-efficiency converter with PFC for LED street lighting applications

By Claudio Spini

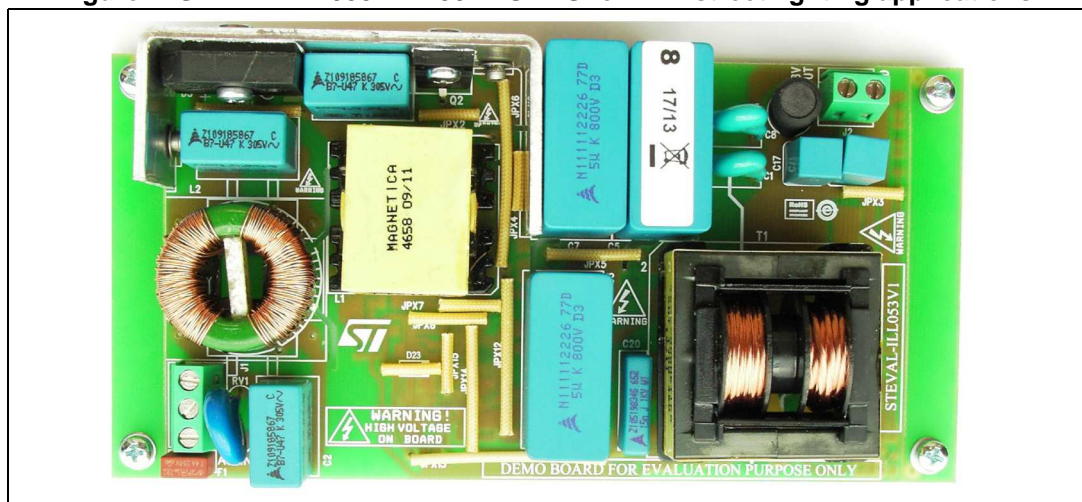
#### Introduction

The use and growing popularity of LEDs, thanks to their high efficiency and very long lifetime, are driving the innovation of different types of lamps and contributing to the reduction of energy consumption for internal and external lighting. Streetlight applications require that the power supply designed to power an LED lamp must have high efficiency and at least an equivalent lifetime in order to guarantee maintenance-free operation during the life of the LED.

This application note describes the characteristics and features of a 130 W evaluation board (STEVAL-ILL053V1), tailored to an LED power supply specification for street lighting. The circuit is composed of two stages: a front-end PFC using the L6562AT and an LLC resonant converter based on the L6599AT. The strengths of this design are very high efficiency, wide input mains range (85 - 305 V<sub>AC</sub>) operation and long-term reliability. Because reliability (MTBF - "mean time between failures") in power supplies is typically affected by the high failure rate of electrolytic capacitors unless using very expensive types, this board shows a very innovative design approach. The board doesn't implement any electrolytic capacitors, but uses instead film capacitors from EPCOS. Component de-rating has been also carefully applied during the design phase, decreasing the stress of the components as recommended by the MIL-HDBK-217D. The number of components, thanks to the use of the new devices L6562AT and L6599AT has also been minimized, thus increasing the MTBF and optimizing the total component cost. Thanks to the high efficiency achieved, just a small heatsink for the PFC stage is needed, while the other power components are SMT (surface mount technology) like most of the passive components, thus decreasing the production labor cost.

The board also has protection features in case of overload, short-circuit, open loop by each stage or input overvoltage. For this particular application, all protections in case of intervention have an auto-restart functionality.

**Figure 1. STEVAL-ILL053V1: 130 W SMPS for LED street lighting applications**



# Contents

- 1 Main characteristics and circuit description ..... 3**
  - 1.1 Power factor corrector ..... 3
  - 1.2 Resonant power stage ..... 4
  - 1.3 Startup sequence ..... 4
  - 1.4 Output voltage feedback loop ..... 4
  - 1.5 Overload and short-circuit protection ..... 5
  - 1.6 Overvoltage and open loop protection ..... 5
- 2 Efficiency measurement ..... 7**
- 3 Input current harmonics measurement ..... 8**
- 4 Functional check ..... 10**
  - 4.1 PFC circuit ..... 10
  - 4.2 Half-bridge resonant LLC circuit ..... 11
  - 4.3 Dynamic load operation ..... 12
  - 4.4 Overcurrent and overvoltage protection ..... 13
  - 4.5 Converter startup ..... 14
- 5 Thermal map ..... 16**
- 6 Conducted emission precompliance measurement ..... 18**
- 7 Bill of material ..... 20**
- 8 PFC coil specifications ..... 25**
- 9 Transformer specifications ..... 28**
- 10 Revision history ..... 30**



# 1 Main characteristics and circuit description

The main features of the SMPS are listed here below:

- Extended input mains range: 85 to 305 V<sub>AC</sub> - frequency 45 to 55 Hz
- Output voltage: 48 V at 2.7 A
- Long-life, electrolytic capacitors are not used
- Mains harmonics: acc. to EN61000-3-2 Class-C
- Efficiency at full load: better than 90% at 115 V<sub>AC</sub>
- EMI: according to EN55022-Class-B, EN55015
- Safety: double insulation, according to EN60950, SELV
- Dimensions: 75 x 135 mm, 30 mm components maximum height
- PCB: single side, 35 µm, FR-4, mixed PTH/SMT

## 1.1 Power factor corrector

The PFC stage, working in transition mode, acts as a preregulator and powers the resonant stage with the output voltage of 450 V. The PFC power topology is a conventional boost converter, connected to the output of the rectifier bridge D3. It is completed by the coil L1, manufactured by MAGNETICA, the diode D2 and the capacitors C5, C6 and C7 in parallel. The PFC output capacitors are film type, 5 µF - 800 V manufactured by EPCOS. Using film capacitors to replace the typical electrolytic capacitors allows increasing considerably the MTBF of the board.

The boost switch is represented by the power MOSFET Q2. The board is equipped with an input EMI filter necessary to filter the commutation noise coming from the boost stage. The PFC implements the controller L6562AT, a small and inexpensive controller that is guaranteed for operation over a wide temperature range.

At startup, the L6562AT is supplied by the startup resistors R5, R8, R13 charging the capacitor C13. Once the PFC begins switching, a charge pump connected to the auxiliary winding of the PFC inductor L1 supplies both PFC and resonant controllers via a small linear regulator implemented by Q1. Once both stages have been activated, the controllers are supplied also by the auxiliary winding of the resonant transformer, assuring correct supply voltage during operation of all load conditions. The L1 auxiliary winding is also connected to the L6562AT pin #5 (ZCD) through the resistor R18. Its purpose is to provide the information that L1 has demagnetized, needed by the internal logic for triggering a new switching cycle. The PFC boost peak current is sensed by resistors R33 and R34 in series to the MOSFET source. The signal is fed into pin #4 (CS) of the L6562AT, via the filter R27 and C16.

The divider R7, R12, R14 and R22 provides the L6562AT multiplier with the information of the instantaneous mains voltage that is used to modulate the peak current of the boost.

The resistors R2, R6, R9 with R15 and R16 are dedicated to sense the output voltage and feed to the L6562AT the feedback information necessary to maintain the output voltage regulated. The components C11, R20 and C12 constitute the error amplifier compensation network necessary to keep the required loop stability.

## 1.2 Resonant power stage

The downstream converter is a resonant LLC half-bridge stage working with 50 percent fixed duty cycle and variable frequency. It implements the ST L6599AT, integrating all functions necessary to properly control the resonant topology.

The resonant transformer, manufactured by MAGNETICA, uses the integrated magnetic approach, so the leakage inductance is used for resonant operation of the circuit. Thus, no external, additional coil is needed for the resonance. The transformer secondary winding configuration is the typical center tap, using a couple of power Schottky rectifiers type STPS10150CG. The output capacitors are film type, 4.7  $\mu$ F - 63 V from EPCOS. As for the PFC stage, using film capacitors allows considerably increasing the MTBF of the board.

A small LC filter has been added on the output, in order to filter the high-frequency ripple.

D21, D22, R55 constitute a voltage-controlled bleeder. In case of no-load operation of the SMPS, this circuit provides a bleeder limiting the output voltage from increasing, but not affecting the efficiency during normal operation. Please note that the converter has not been designed to work in this condition and therefore its mains consumption is not optimized (~3 W).

## 1.3 Startup sequence

The PFC acts as master and therefore starts first. The resonant stage operates only if the PFC is delivering the nominal output voltage to prevent the resonant converter from working with an insufficient input voltage that can cause incorrect capacitive mode operation. Thus, both stages are designed to work according to this sequence.

For correct sequencing the L6599AT makes use of the LINE pin (#7) to sense the PFC output voltage via a resistor divider. The L6599AT LINE pin (#7) has an internal comparator which has a hysteresis allowing to set independently the turn-on and turn-off voltage. At startup the LLC stage starts once the PFC output voltage reaches ~ 430 V, while the turn-off threshold has been set to ~330 V.

## 1.4 Output voltage feedback loop

The output voltage is kept stable by means of a feedback loop implementing a typical circuit using a TS2431 modulating the current in the optocoupler diode.

On the primary side, R43 - connecting pin RF<sub>MIN</sub> (#4) to the optocoupler's phototransistor - allows modulating the L6599AT oscillator frequency, thus keeping the output voltage regulated. It also sets the maximum switching frequency at about 130 kHz. R42, that connects the same pin to ground, sets the minimum switching frequency. The R-C series R37 and C24 sets both soft-start maximum frequency and duration.

All evaluation boards implement the voltage loop circuitry previously described but in case a current loop is also required, it can be achieved by implementing the following modifications:

- Replace R30 and R31 0R0  $\Omega$  resistors with sensing resistors, 0R033 and 0R039 respectively, both 0805
- Populate on PCB U4 and the relevant components shown on the schematic as N.M:  
C36 = 1N0-0805; C37 = 100NF-0805; R51 = 15R-0805; R56 = 1K0-0805;  
R6 = 22K-1206; C41 = 2N2-0805; U5 = SEA05TR
- Remove TS2431AILT

With these modifications the circuit is able to keep the output current constant at 2.7 A down to an output voltage value around 30 V. This function can be used to optimize the voltage drop and power dissipation in case current linear regulators are used to regulate the current flowing in each LED strip. If the output current is lower, the voltage loop will take over the operation, regulating the output voltage at its nominal value as when using the TS2431AILT.

## 1.5 Overload and short-circuit protection

The current flowing into the primary winding, proportional to the output load, is sensed by the lossless circuit C34, R53, D19, D18, R57, and C35 and it is fed into the ISEN pin (#6) of L6599AT. In case of overcurrent, the voltage on the pin will exceed an internal threshold (0.8 V), triggering a protection sequence. The capacitor (C21) connected to the DELAY pin (#2) is charged by an internal 150  $\mu$ A current generator. If the voltage on the pin reaches 2 V, the soft-start capacitor is completely discharged so that the switching frequency is pushed to its maximum value. As the voltage on the pin exceeds 3.5 V the IC stops switching and the internal generator is turned off, so that the voltage on the DELAY pin will decay because of the external resistor connected between the pin and GND. The L6599AT will be soft-restarted as the voltage drops below 0.3 V. In this way, under short-circuit conditions, the converter will work intermittently with low input average power and thus limiting the stress of components during shorts.

## 1.6 Overvoltage and open loop protection

Both circuit stages, PFC and resonant, are equipped with their own overvoltage protections.

The PFC controller L6562AT implements an overvoltage protection against the output voltage variation occurring in case of transients, due to the poor bandwidth of the error amplifier. Unfortunately it cannot protect the circuit in case of a feedback loop failure like disconnection or deviation from the nominal value of the feedback loop divider. If a similar failure condition is detected, the L6599AT pin DIS (#8) stops the operation and also stops the PFC operation by means of the L6599AT pin PFC\_STOP (#9) connected to the L6562AT pin INV (#1). The converter operation will be latched until the  $V_{CC}$  capacitors are discharged, then a new startup sequence will automatically take place and the converter will resume operation if the failure is removed or a new sequence is triggered. The same sequence occurs also in case of input voltage transients that may damage the converter.

The DIS pin is also used to protect the resonant stage against loop failures. The Zener diode D17 detects the auxiliary voltage generated by the LLC transformer. In case a loop failure occurs, it conducts and the voltage on pin DIS exceeds the internal threshold, latching off the device. The L6562AT operation will be stopped too by the PFC\_STOP pin, like in the previous case and then after some time the circuit will restart.



## 2 Efficiency measurement

[Table 1](#) shows the overall efficiency, measured at 230 V - 50 Hz and 115 V - 60 Hz input voltage and different loads.

At 115 V<sub>AC</sub> and full load the overall efficiency is 90.96%. It increases up to 93.38% at 230 V<sub>AC</sub>, confirming that this reference design is suitable for high-efficiency power supplies. The efficiency has been measured at 25%, 50%, 75% and 100%, and the average efficiency according to the ES-2 standard has been calculated. As shown in [Table 1](#) it is very high at both nominal mains.

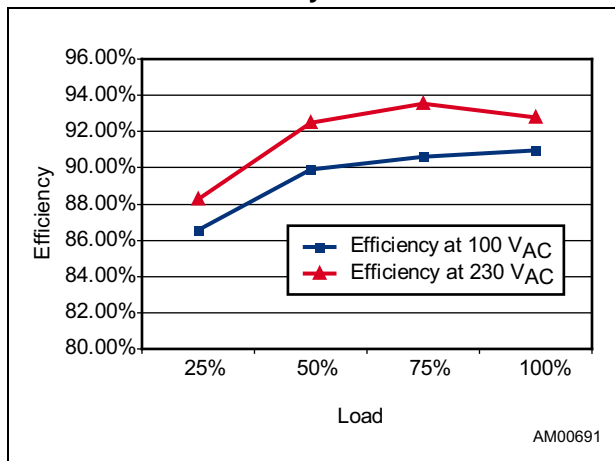
**Table 1. STEVAL-ILL053V1 evaluation board: overall efficiency vs. load**

Load	230 V - 50 Hz					115 V - 60 Hz					
	V <sub>OUT</sub> [V]	I <sub>OUT</sub> [A]	P <sub>OUT</sub> [W]	P <sub>IN</sub> [W]	Eff. [%]	V <sub>OUT</sub> [V]	I <sub>OUT</sub> [A]	P <sub>OUT</sub> [W]	P <sub>IN</sub> [W]	Eff. [%]	
25% load	47.58	0.689	32.8	37.87	86.57%	47.59	0.689	32.8	37.87	86.58%	
50% load	47.57	1.378	65.6	71.66	91.48%	47.58	1.378	65.6	72.93	89.90%	
75% load	47.56	2.008	95.5	102.96	92.75%	47.56	2.001	95.2	105.0	90.64%	
100% load	47.55	2.708	128.8	137.6	93.38%	47.56	2.703	128.6	141.33	90.96%	
Average efficiency											89.52%

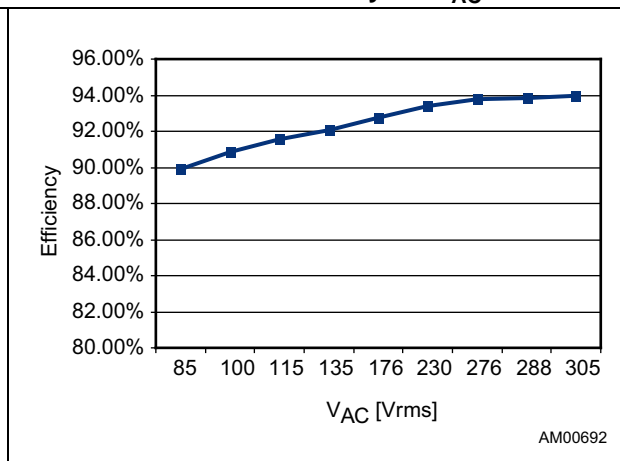
The measured output voltage at different load conditions is also shown in [Table 1](#). As visible, the voltage is very stable over the entire output load range.

The measured efficiency is shown in [Figure 3](#), while [Figure 4](#) shows the efficiency at maximum load over the entire AC input voltage mains range.

**Figure 3. STEVAL-ILL053V1 evaluation board: efficiency vs. load**



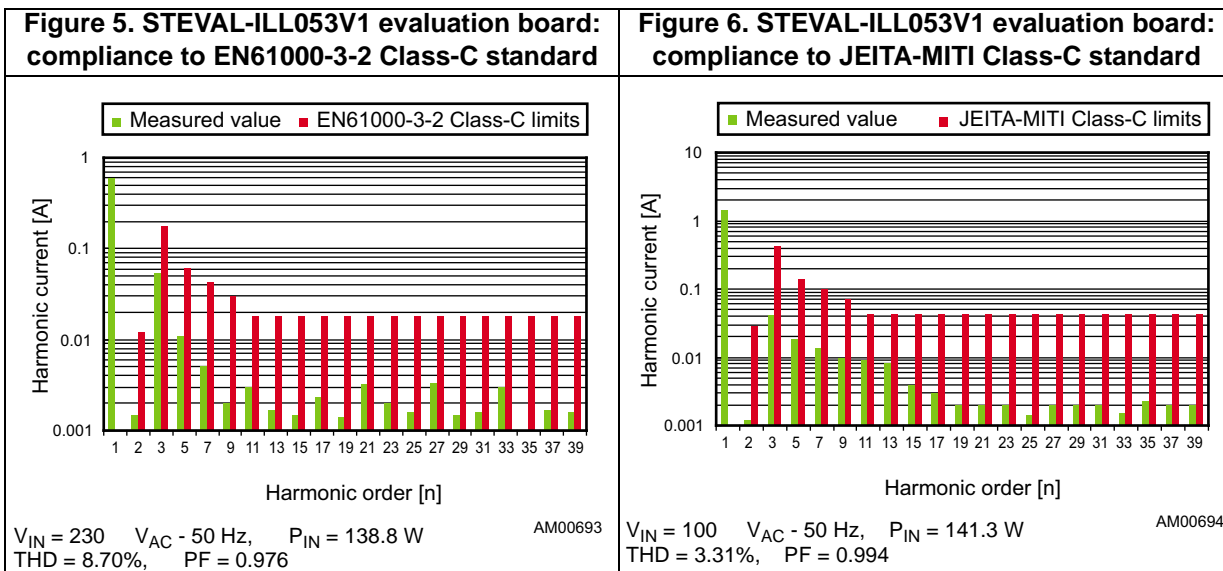
**Figure 4. STEVAL-ILL053V1 evaluation board: full-load efficiency vs. V<sub>AC</sub>**





### 3 Input current harmonics measurement

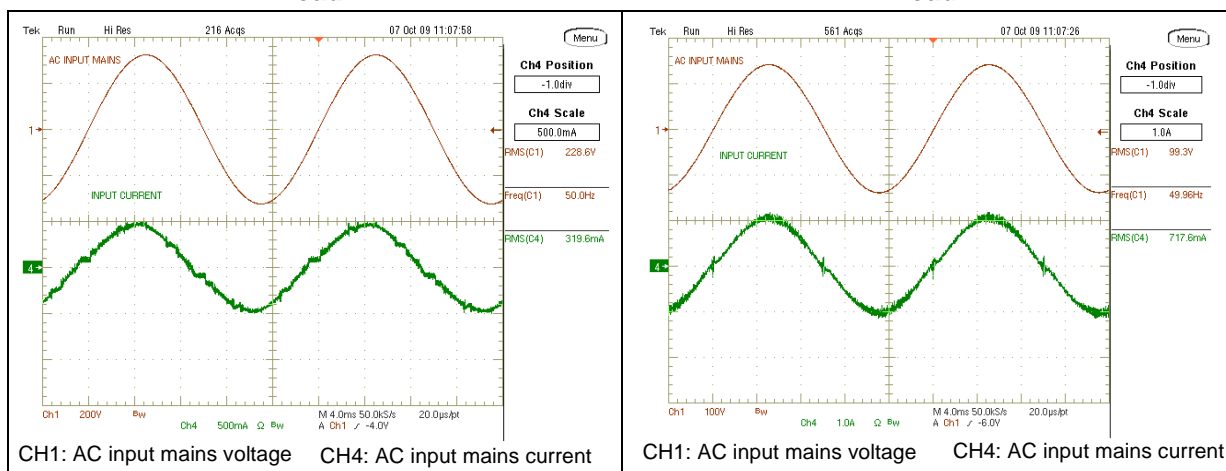
One of the main purposes of a PFC precondition is the correction of input current distortion, decreasing the harmonic contents below the limits of the relevant regulations. Therefore, this evaluation board has been tested according to the European norm EN61000-3-2 Class-C and Japanese norm JEITA\_MITI Class-C both relevant to lighting equipment, at full load and nominal input voltage mains. The measurements are shown in [Figure 5](#) and [Figure 6](#).



For user reference, waveforms of the input current and voltage at nominal input voltage mains during full-load operation are shown in [Figure 5](#) and [Figure 6](#). [Figure 7](#) and [Figure 8](#) give the input current and voltage at nominal input voltage mains 50% load, showing that in spite of the wide input voltage range, the current waveform shape is still good.

**Figure 7. STEVAL-ILL053V1 evaluation board: input current waveform at 230 V - 50 Hz - 65 W load**

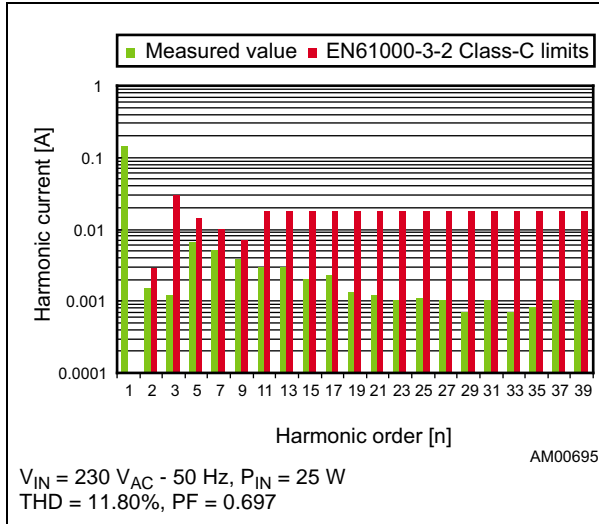
**Figure 8. STEVAL-ILL053V1 evaluation board: input current waveform at 100 V - 50 Hz - 65 W load**



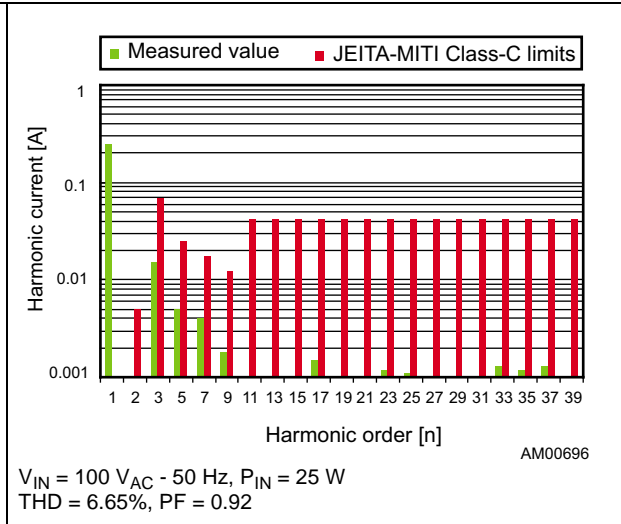


As confirmed by the previous graphs, the circuit also shows its ability to reduce the harmonics well below the limits of EN61000-3-2 Class-C regulation not only at full load but also at a significantly lower load. The input current harmonics measurement at 25 W (minimum input power to be compliant with the previously mentioned rules is 25 W) shows that even if the power supply is working from its typical operating region, it is still compliant with the EN61000-3-2 Class-C limits. Test results are shown in [Figure 9](#) and [Figure 10](#).

**Figure 9. STEVAL-ILL053V1 evaluation board: compliance to EN61000-3-2 Class-C standard**

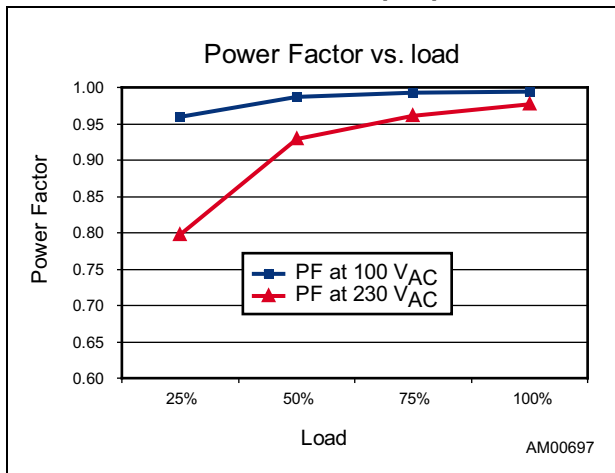


**Figure 10. STEVAL-ILL053V1 evaluation board: compliance to JEITA-MITI Class-C standard**

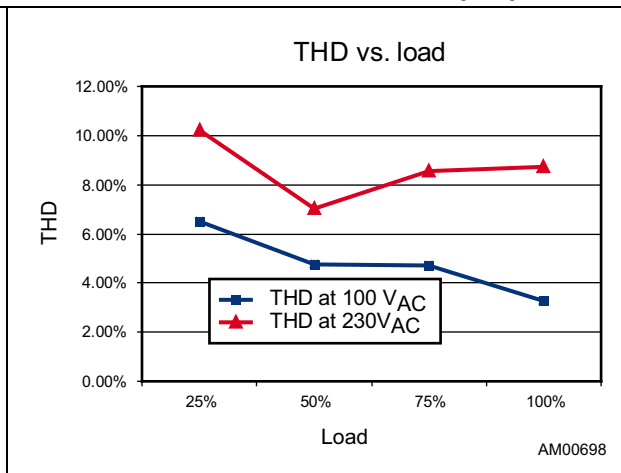


The “Power Factor” (PF) and the “Total Harmonic Distortion” (THD) versus load variations have been measured too and the results are shown in [Figure 11](#) and [Figure 12](#). As visible, the Power Factor remains close to unity and the Total Harmonic Distortion is very low throughout the input voltage mains.

**Figure 11. STEVAL-ILL053V1 evaluation board: Power Factor vs. output power**



**Figure 12. STEVAL-ILL053V1 evaluation board: Total Harmonic Distortion vs. output power**

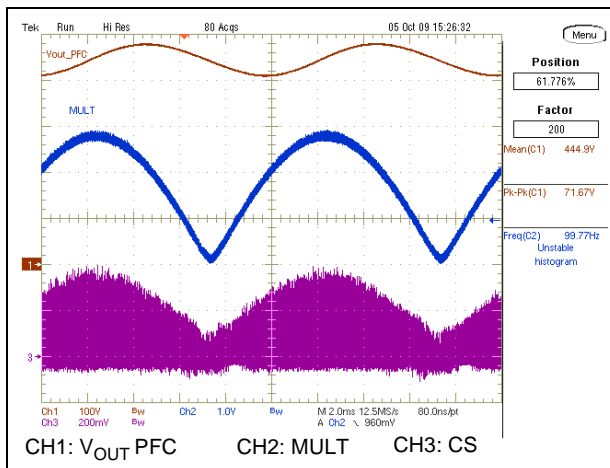


# 4 Functional check

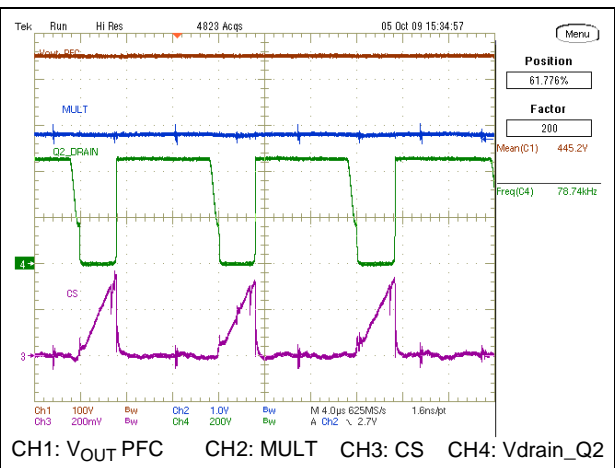
## 4.1 PFC circuit

In [Figure 13](#) and [Figure 15](#) some waveforms relevant to the PFC stage have been captured during full load operation at nominal 230 V<sub>AC</sub> and 115 V<sub>AC</sub>. In both figures it is visible that the envelope of the CS pin (#4) waveforms of the L6562AT is in phase with the MULT pin (3#) and has same sinusoidal shape, demonstrating the proper functionality of the PFC stage. It is also possible to measure the peak-to-peak value of the voltage ripple superimposed on the PFC output voltage due to the low value of the PFC output capacitors. In [Figure 14](#) and [Figure 16](#) the details of some waveforms at the switching frequency are shown.

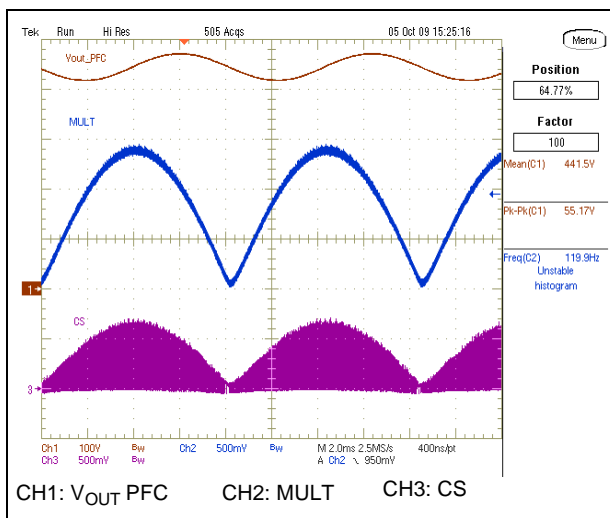
**Figure 13. STEVAL-ILL053V1 evaluation board: PFC stage and L6562AT waveforms at 230 V - 50 Hz - full load**



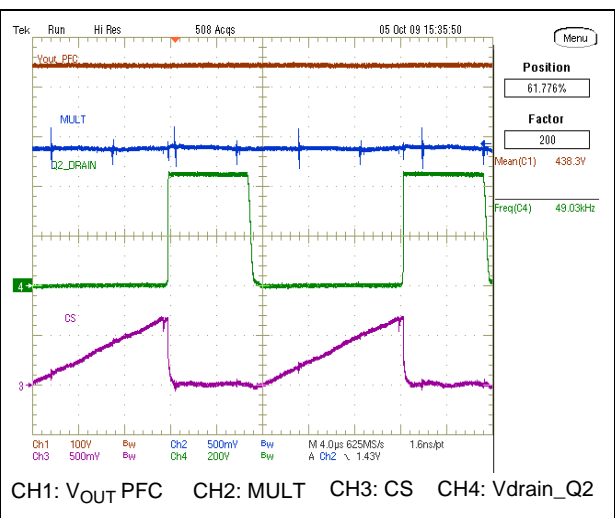
**Figure 14. STEVAL-ILL053V1 evaluation board: PFC stage and L6562AT waveforms at 230 V - 50 Hz - full load - detail**



**Figure 15. STEVAL-ILL053V1 evaluation board: PFC stage and L6562AT waveforms at 115 V - 60 Hz - full load**



**Figure 16. STEVAL-ILL053V1 evaluation board: PFC stage and L6562AT waveforms at 115 V - 60 Hz - full load - detail**



## 4.2 Half-bridge resonant LLC circuit

The following figures show waveforms relevant to the resonant stage during steady-state operation. The resonant stage switching frequency is about 100 kHz, in order to have a good trade-off between transformer losses and dimensions.

The LLC converter has been designed to operate at nominal voltage and full load at the resonance frequency, but due to the PFC output voltage ripple at twice the mains frequency, it is driven slightly above and below the resonant tank frequency, according to the instantaneous value of the PFC output voltage.

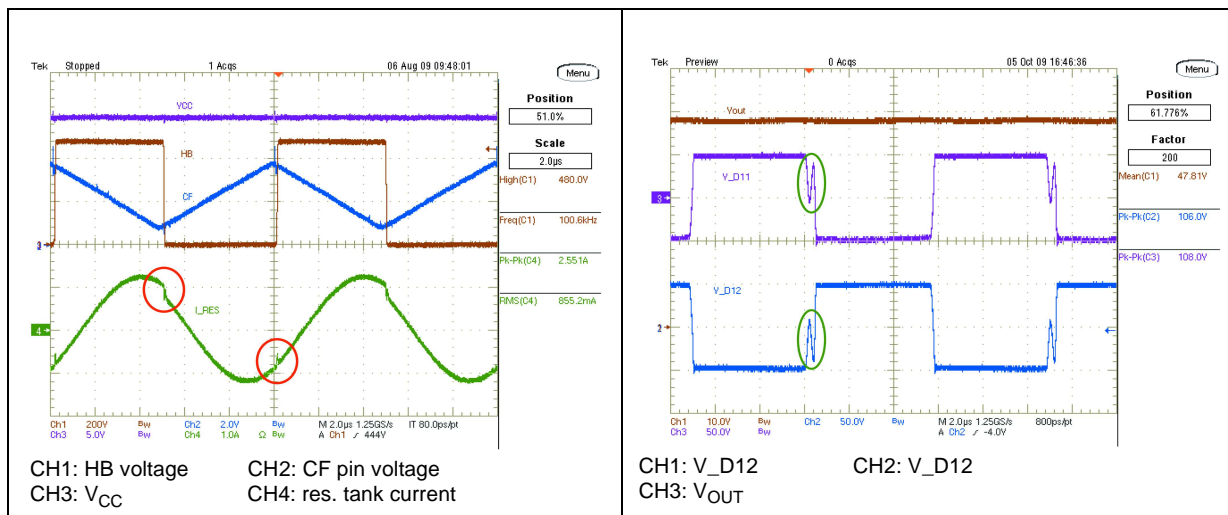
In *Figure 17* some waveforms relevant to the resonant stage ZVS operation are shown. We note that both MOSFETs are turned on when resonant current is flowing through their body diodes and drain-source voltage is almost zero, thus achieving good efficiency because the turn-on losses are negligible. The HB MOSFET voltage de-rating and low operating temperature allow increasing the board's MTBF.

The current flowing in the resonant tank is sinusoidal. In *Figure 17* we note a slight asymmetry of operating modes by each half portion of the sine wave. The half cycle is working at resonant frequency while the other one is working above the resonant frequency. This is due to a small difference between each half-secondary leakage inductance of the transformer reflected to the primary side, providing the two slightly different resonant frequencies. This phenomenon is typically due to a different coupling of the transformer secondary windings and, in this case, it is not an issue. The slight asymmetry is also visible in *Figure 18* where the small ringing appearing on both secondary rectifiers anode voltage indicates that for a short time the rectifiers are not conducting. This demonstrates that during the half cycle the circuit is working below the resonant frequency, while during the following half cycle it is working at the resonant frequency.

In *Figure 18* we also note the rectifier operating voltage and its margin with respect to the maximum reverse voltage ( $V_{RRM}$ ). This de-rating with respect to the rectifiers  $V_{RRM}$  guarantees good reliability of the output rectifiers, increasing the board's total MTBF.

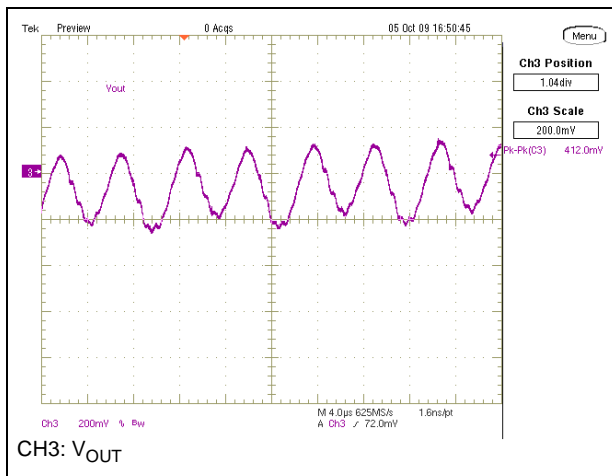
**Figure 17. STEVAL-ILL053V1 evaluation board: primary side LLC waveforms at 115 V - 60 Hz - full load**

**Figure 18. STEVAL-ILL053V1 evaluation board: secondary side LLC waveforms at 230 V- 50 Hz - full load**

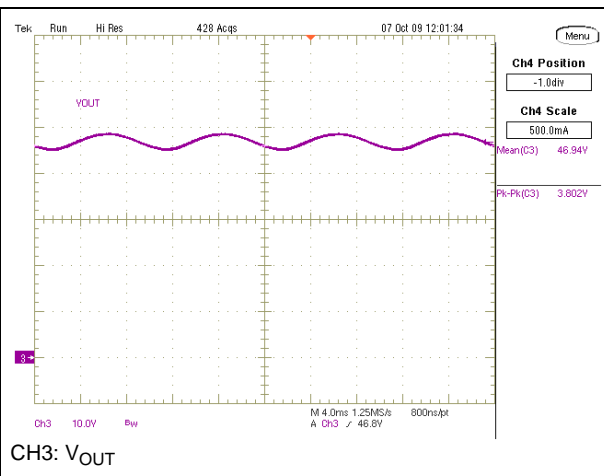


In [Figure 19](#) the high-frequency ripple has been measured. As visible the ripple and noise at switching frequency is very limited, thanks to the low EMI generated by both stages. In [Figure 20](#) the low-frequency ripple has been measured too. We note that the peak-to-peak value is not very low because of the low output capacitances but it doesn't affect the application. In fact the converters regulating the current flowing in each LED strip can reject the ripple without any problem.

**Figure 19. STEVAL-ILL053V1 evaluation board: high frequency ripple on output voltage at 115 V - 60 Hz - full load**



**Figure 20. STEVAL-ILL053V1 evaluation board: low frequency ripple on output voltage at 115 V - 60 Hz - full load**



### 4.3 Dynamic load operation

The waveforms shown in [Figure 21](#) and [Figure 22](#) pertain to the evaluation board during the operation of supplying converters dedicated to power LED strips with constant current.

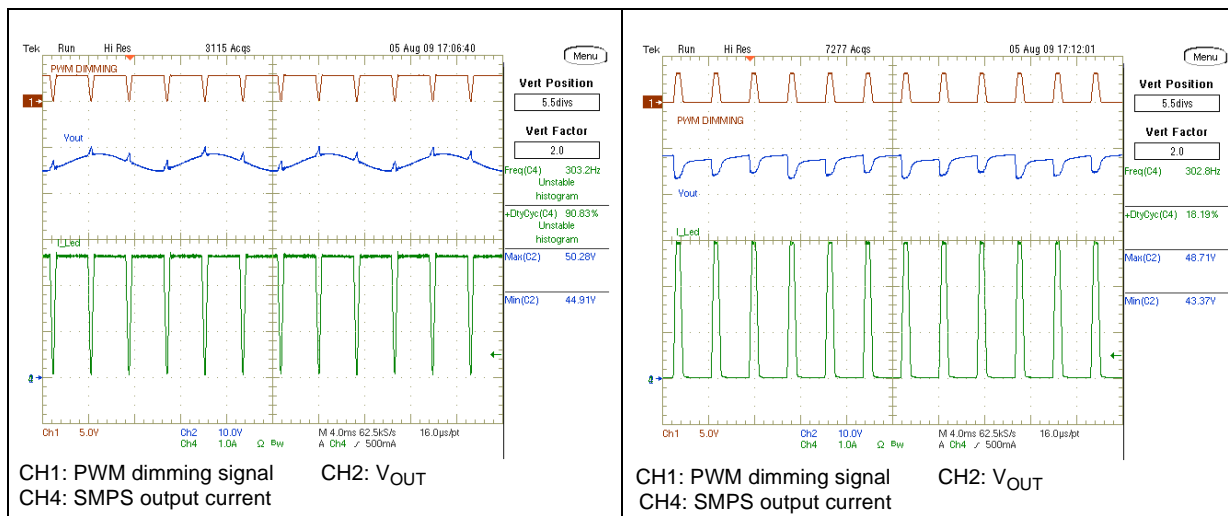
In both figures it is possible to see the output voltage modulation during operation with variable load due to the dimming of the LED current by PWM. For both measurements, the dimming frequency has been chosen at 300 Hz, a typical value for dimming.

In [Figure 21](#) the converter's output current was 2.6 A and the dimming duty cycle was 90%, thus very close to the converter's nominal output power. The output voltage has two modulations. One is due to the rejection of the PFC output voltage ripple already measured in [Figure 20](#) where the voltage variation due to the LED current dimming is superimposed. The peak-to-peak variation is 5.37 V but it doesn't present any problem for the load since the converters reject the modulation.

In [Figure 22](#) instead the converter has been checked at light load, so the peak output current was 3 A and the dimming duty cycle was 15%, for an output power of 21 W. Even in this case, the peak-to-peak modulation doesn't present any issue for the downstream current regulators and the board still works correctly.

**Figure 21. STEVAL-ILL053V1 evaluation board: output voltage variation driving a CC LED converter - PWM = 90%**

**Figure 22. STEVAL-ILL053V1 evaluation board: output voltage variation driving a CC LED converter - PWM = 15%**



Please note that for correct operation with LED strips, the board needs additional capacitors connected on the +48 V output bus. The board has not been equipped with all of the capacitors necessary for correct operation with LEDs, but only with minimum capacitance to allow board operation in order to optimize the system cost and reliability. The additional capacitors needed are intended to be placed close to each LED strip current regulator, thus filtering the EMI generated by these. In several cases, in fact, the power supply is placed at the base of the lighting pole while the LED current regulators are located on top, in the lamp. The long connection wiring between the power supply and the converters can act as an antenna radiating EMI. Thus local filtering minimizes the radiated EMI.

The capacitance to be added to the 48 V bus for correct operation with LEDs is around 40  $\mu$ F. In order to not affect the board MTBF, we suggest using the same type of capacitors already used on the power supply board.

#### 4.4 Overcurrent and overvoltage protection

The L6599AT is equipped with a current sensing input (pin #6, ISEN) and a dedicated overcurrent management system. The current flowing in the resonant tank is detected and the signal is fed into the ISEN pin. It is internally connected to a first comparator, referenced to 0.8 V, and to a second comparator referenced to 1.5 V. If the voltage externally applied to the pin exceeds 0.8 V, the first comparator is tripped, causing an internal switch to be turned on and discharging the soft-start capacitor C24 (CSS).

Under output short-circuit, this operation results in a nearly constant peak primary current.

With the L6599AT the designer can program externally the maximum time that the converter is allowed to run overloaded or under short-circuit conditions. Overloads or short-circuits lasting less than the set time will not cause any other action, hence providing the system with immunity to short duration phenomena. If, instead, the overload condition persists, a protection procedure is activated that shuts down the L6599AT. In case of continuous overload or short-circuit, it will result in continuous intermittent operation with a user-defined duty cycle.

This function is implemented with the DELAY pin (#2), by means of a capacitor C21 and the parallel resistor R32 connected to ground. As the voltage on the ISEN pin exceeds 0.8 V, the first OCP comparator, in addition to discharging CSS, turns on an internal 150  $\mu$ A current generator that via the DELAY pin charges C21. As the voltage on C21 is 3.5 V, the L6599AT stops switching and the PFC\_STOP pin (#9) is pulled low, turning off also the PFC stage via the L6562AT pin#1 (INV). The internal generator is also turned off, so that C21 will now be slowly discharged by R32. The IC will restart once the voltage on C21 is less than 0.3 V. Additionally, if the voltage on the ISEN pin reaches 1.5 V for any reason (e.g. transformer saturation), the second comparator will be triggered, the L6599AT will shut down and the operation will be resumed after recycling of the  $V_{CC}$ . In this evaluation board the intervention of the second level comparator will latch the operation of the L6599AT and the PFC\_STOP pin (#9) will stop the PFC. Both controllers will no longer be powered by  $V_{CC}$  and the latch will be removed and then a new startup cycle will take place. This sequence continues until the short is removed.

Figure 23 shows the operation of the DELAY pin and the consequent hiccup mode operation of the board during short-circuit operation. Thanks to the narrow operating time with respect to the off-time, the average output current as well as the average primary current are limited. This will avoid converter overheating and consequent failures. Removing the short allows the board to resume normal operation.

Figure 23. STEVAL-ILL053V1 evaluation board: short-circuit at 115  $V_{AC}$  - 60 Hz - full load

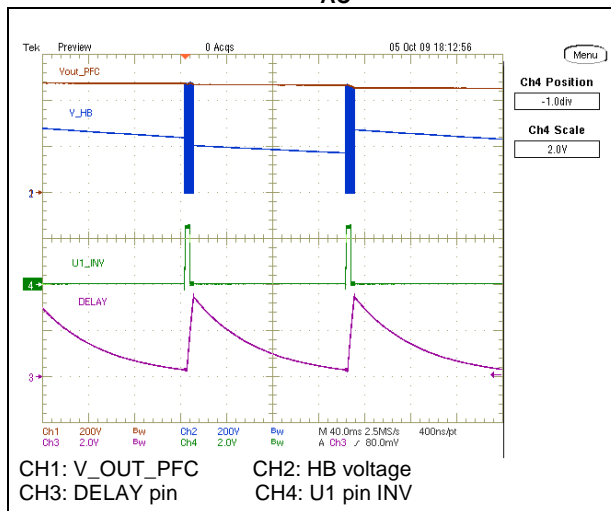


Figure 24. STEVAL-ILL053V1 evaluation board: open loop at 115  $V_{AC}$  - 60 Hz - 65 W load

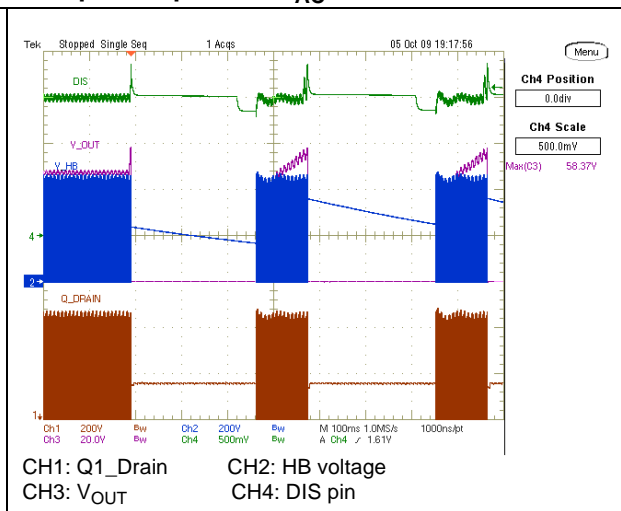


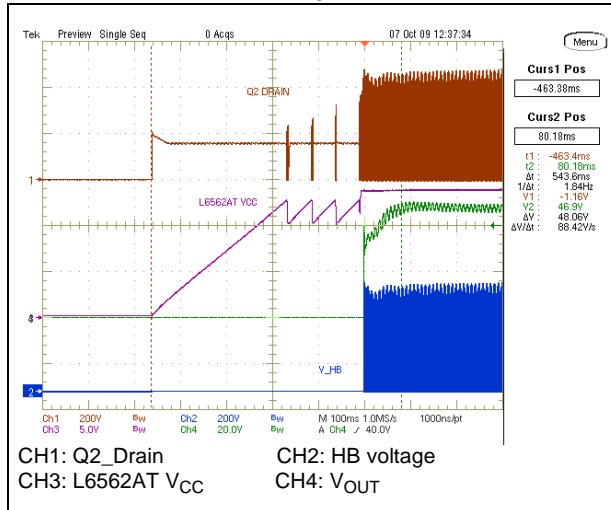
Figure 24 shows the operation of the evaluation board during “open loop” operation by the LLC stage. The open loop operation provides an increase also of the auxiliary voltage that will trigger the L6599AT pin #9 (DIS) protection pin via the Zener diode D17. As a consequence, the L6599AT will shut down, stopping the operation. The L6599AT will activate also the PFC\_STOP pin (#9) that will stop the PFC too, thus both controllers will no longer be powered by  $V_{CC}$ . Once  $V_{CC}$  drops below the UVLO, the latch is removed and then a new startup cycle will take place. This sequence continues until the open loop is removed.

### 4.5 Converter startup

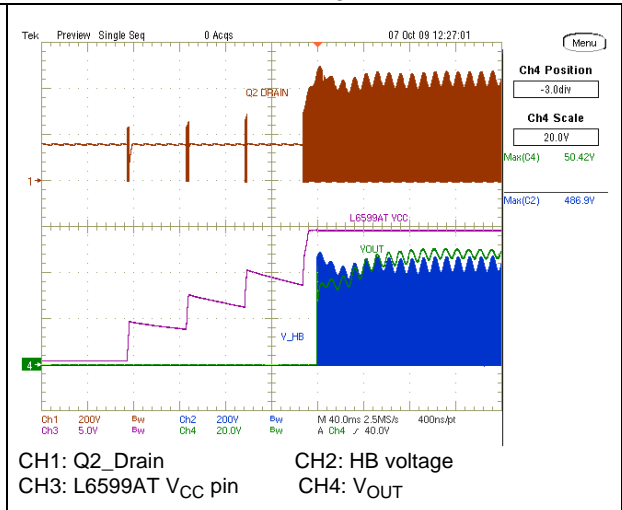
Figure 25 and Figure 27 show the converter startup. We note that at 115  $V_{AC}$  the converter begins operation in ~300 ms, while at 230  $V_{AC}$  it takes around 150 ms. This is the time

needed to charge the  $V_{CC}$  to the L6562AT turn-on voltage. Thus the L6562AT starts switching and the PFC output voltage starts increasing. Once the PFC output voltage reaches the enable level set via the L6599AT LINE pin, even the LLC stage starts switching and the output voltage rises up to the nominal level. The  $V_{CC}$  is initially supplied by the PFC coil charge pump, and then once the L6599AT starts operating, the  $V_{CC}$  is also provided by the LLC transformer auxiliary winding. The details of converter sequencing can be found in [Figure 26](#) and [Figure 28](#).

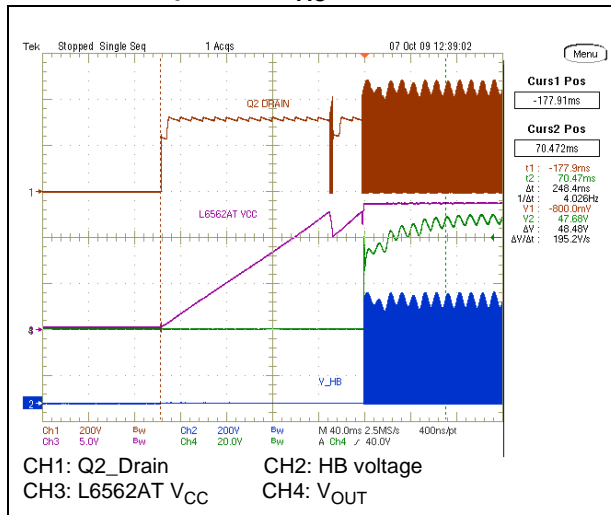
**Figure 25. STEVAL-ILL053V1 evaluation board: wake-up at 115 V<sub>AC</sub> - 60 Hz - full load**



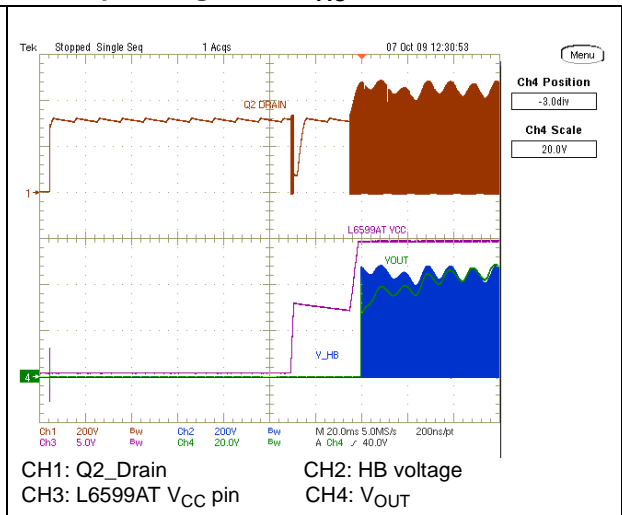
**Figure 26. STEVAL-ILL053V1 evaluation board: sequencing at 115 V<sub>AC</sub> - 60 Hz - full load**



**Figure 27. STEVAL-ILL053V1 evaluation board: wake-up at 230 V<sub>AC</sub> - 50 Hz - full load**



**Figure 28. STEVAL-ILL053V1 evaluation board: sequencing at 230 V<sub>AC</sub> - 60 Hz - full load**



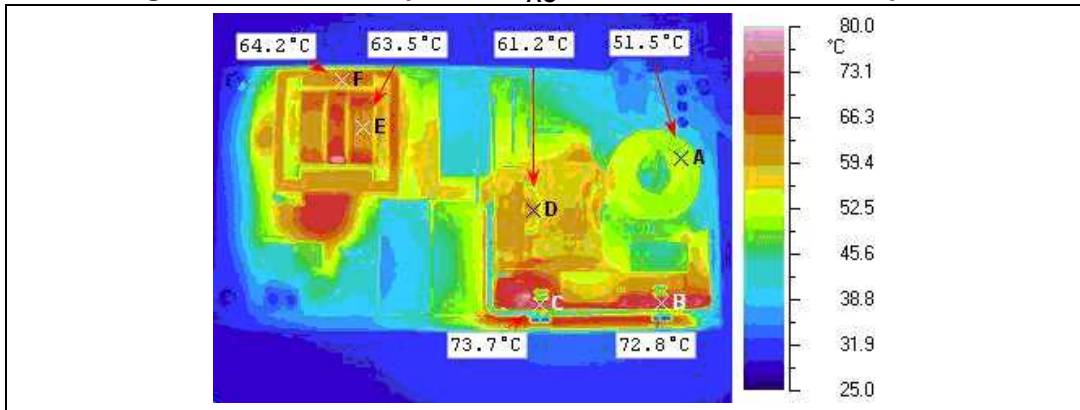
[Figure 25](#) through [28](#) show a correct startup of the board using an active load, with only the capacitors for the 48 V populating the board. Powering current regulators with LEDs may cause the board to show an incorrect startup, with output voltage going up and down and LEDs flashing. As already explained in [Section 4.3](#), the board needs an additional 40  $\mu$ F capacitance on the +48 V.



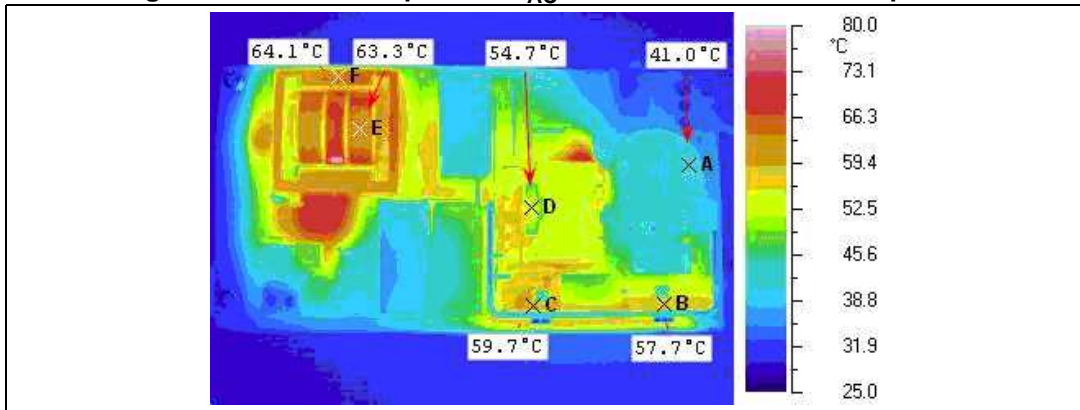
## 5 Thermal map

In order to check the design reliability, a thermal mapping by means of an IR camera was done. Here below the thermal measures of the board, component side, at nominal input voltage are shown. Some pointers visible on the pictures have been placed across key components or components showing high temperature. The ambient temperature during both measurements was 27 °C. We note that the PFC part has a different temperature depending on the input mains, while the components of the resonant stage are working at a temperature independent of the mains input voltage.

**Figure 29. Thermal map at 115 V<sub>AC</sub> - 60 Hz - full load - PCB top side**



**Figure 30. Thermal map at 230 V<sub>AC</sub> - 50 Hz - full load - PCB top side**



**Table 2. Thermal maps reference points - PCB top side**

Point	Reference	Description
A	L2	EMI filtering inductor
B	D3	Bridge rectifier
C	Q2	PFC MOSFET
D	L1	PFC inductor
E	T1	Resonant power transformer - winding
F	T1	Resonant power transformer - ferrite core

Figure 31. Thermal map at 115 V<sub>AC</sub> - 60 Hz - full load - PCB bottom side

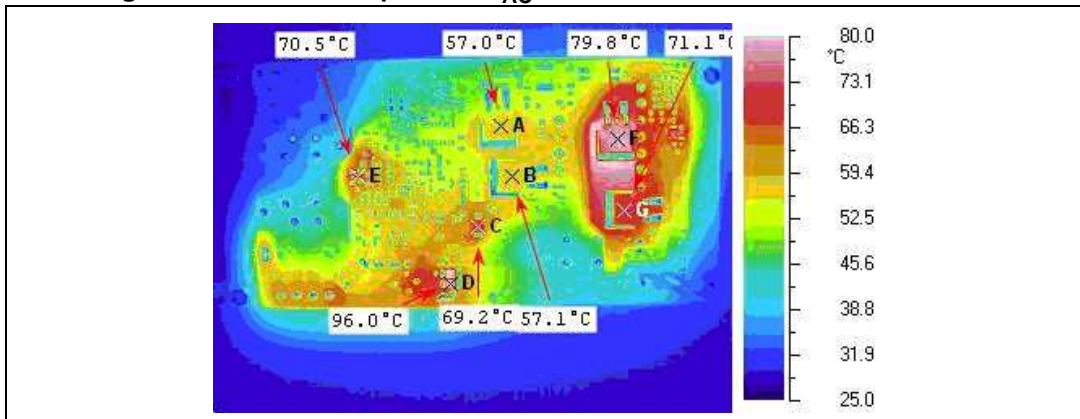


Figure 32. Thermal map at 230 V<sub>AC</sub> - 50 Hz - full load - PCB bottom side

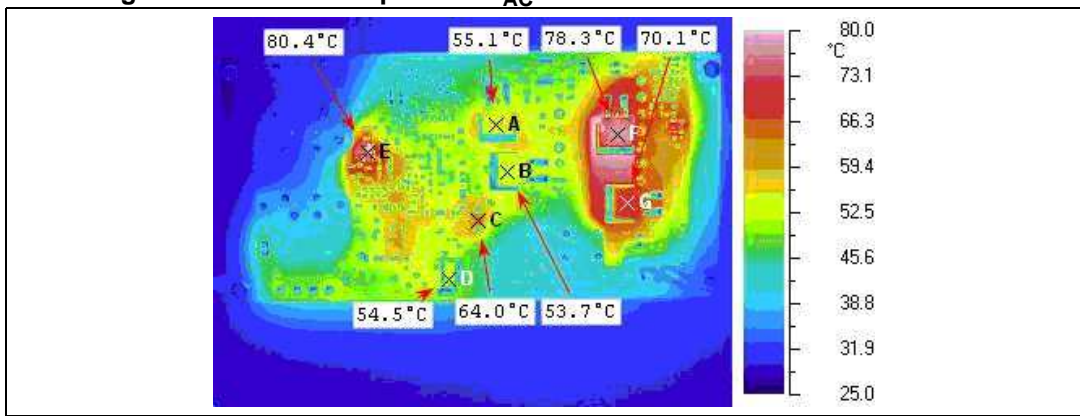


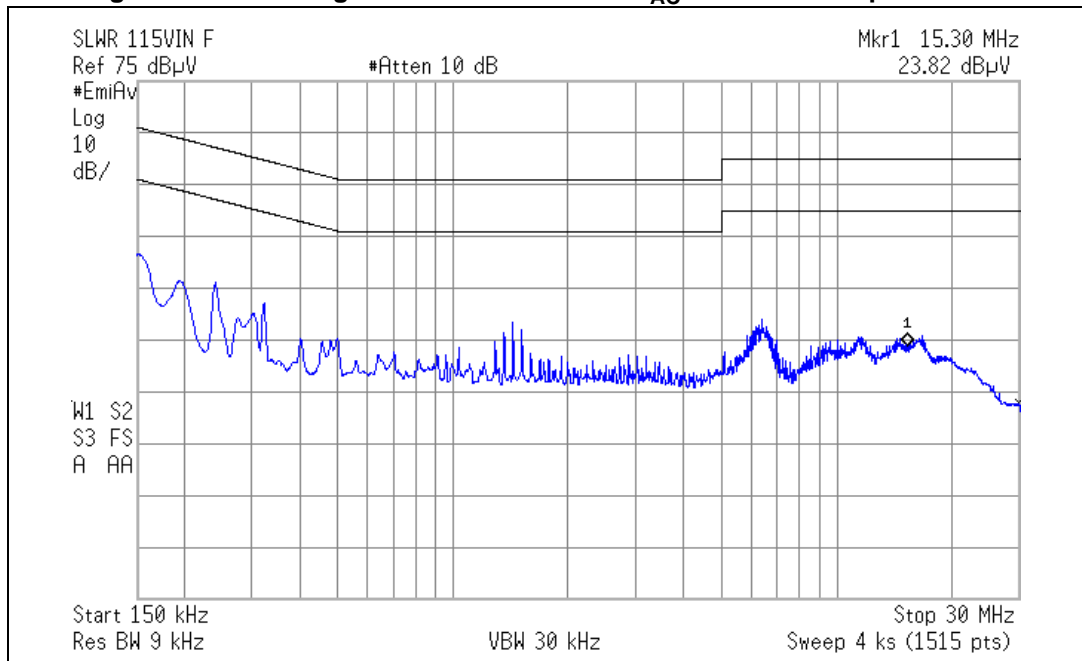
Table 3. Thermal maps reference points - PCB bottom side

Point	Reference	Description
A	Q4	LLC resonant HB MOSFET
B	Q5	LLC resonant HB MOSFET
C	D2	PFC output diode
D	R33 and R34	PFC sense resistors
E	Q1	V <sub>CC</sub> voltage regulator
F	D12	Output rectifier
G	D11	Output rectifier

## 6 Conducted emission precompliance measurement

Figure 33 to Figure 36 show the average measurement of the conducted noise at full load and nominal mains voltages for both wires, line and neutral. The limits on the diagrams are the EN55022 Class-B norms. As visible on the diagrams, in all test conditions the measurements are well below the limits.

**Figure 33. CE average measurement at 115 V<sub>AC</sub> and full load - phase wire**



**Figure 34. CE average measurement at 115 V<sub>AC</sub> and full load - neutral wire**

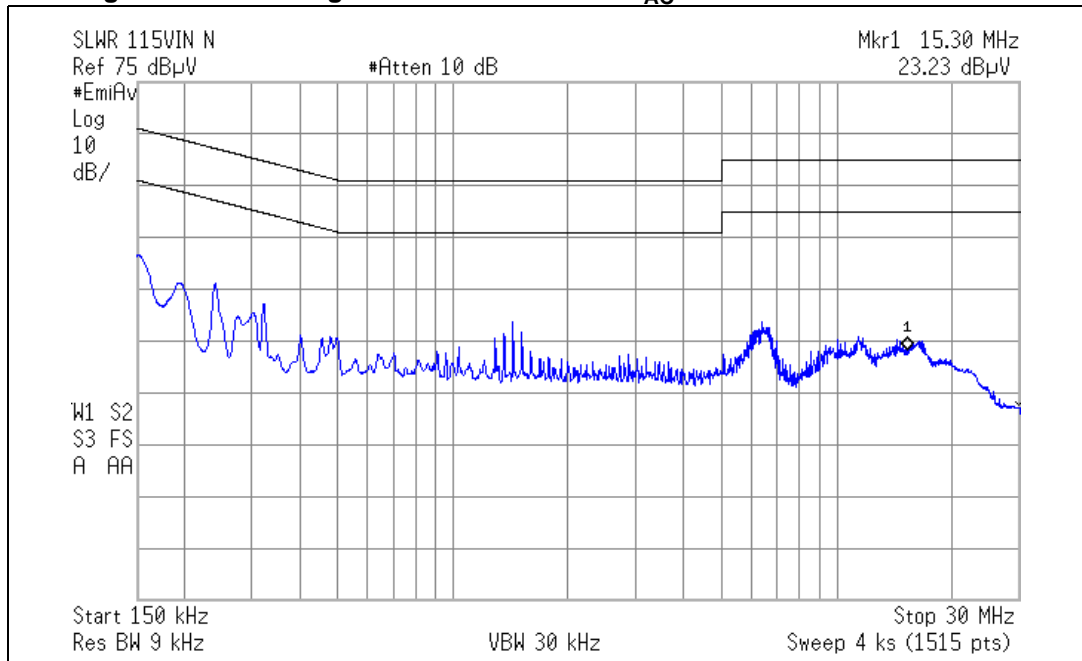


Figure 35. CE average measurement at 230 V<sub>AC</sub> and full load - phase wire

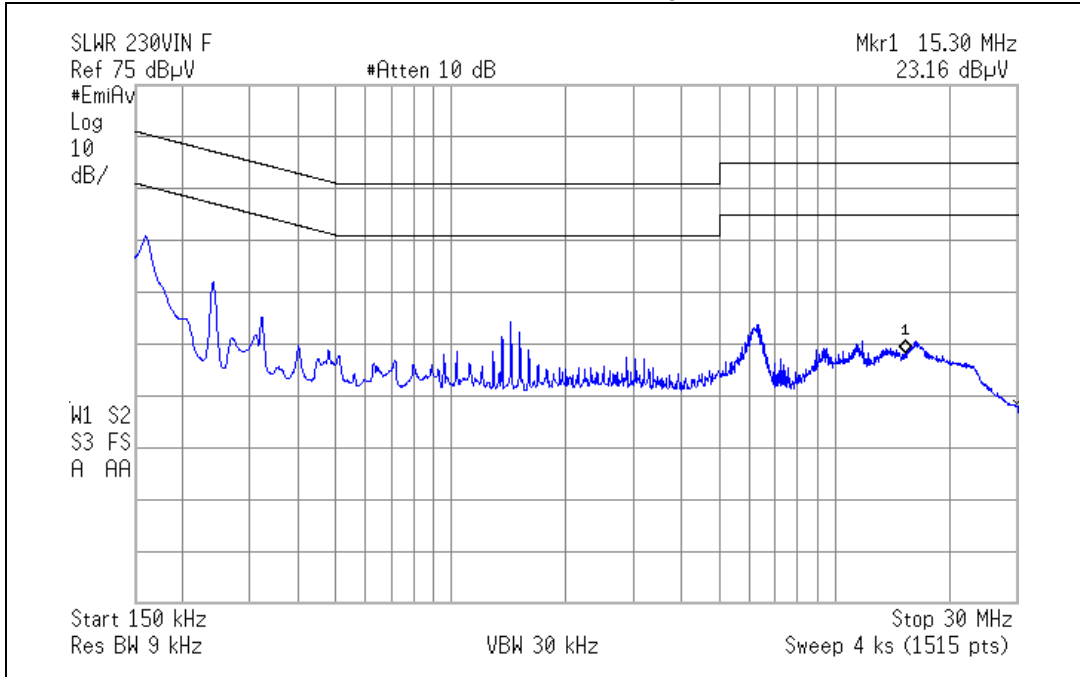
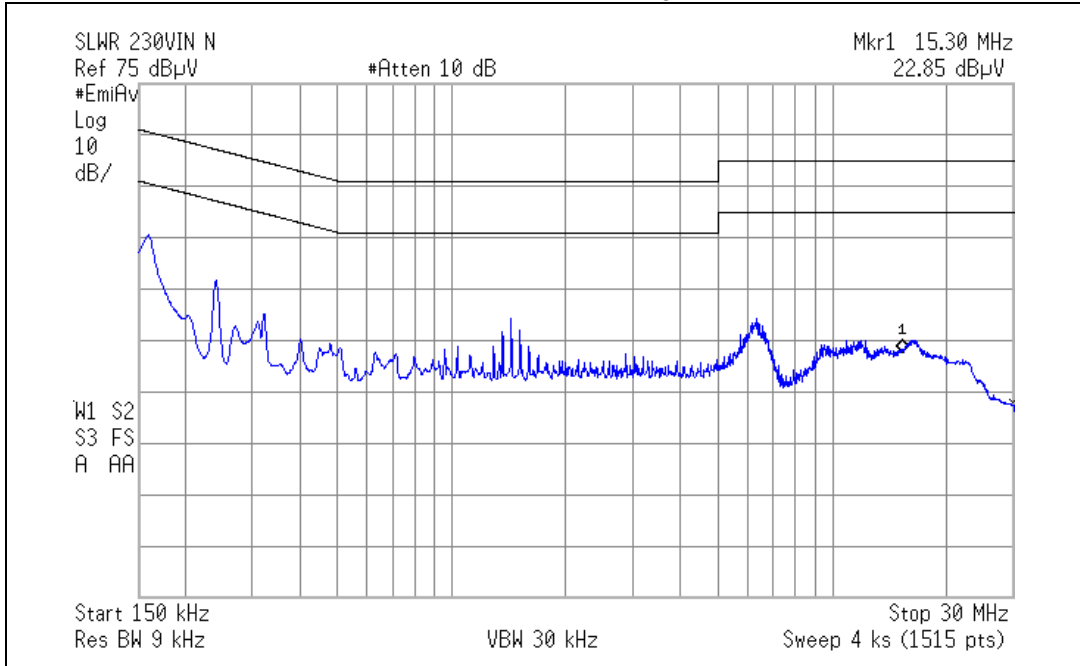


Figure 36. CE average measurement at 230 V<sub>AC</sub> and full load - neutral wire



## 7 Bill of material

Table 4. STEVAL-ILL053V1 evaluation board: bill of material

Des.	Part type / part value	Case style / package	Description	Supplier
C1	2.2 nF - Y1	4.5 x 12.0 p.10 mm	Y1 safety cap. DE1E3KX222M	Murata
C10	1 $\mu$ F	1206	50 V CERCAP - general purpose - X7R- 10%	TDK <sup>®</sup>
C11	470 nF	0805	16 V CERCAP - general purpose - X7R - 10%	Murata
C12	2.2 $\mu$ F	0805	10 V CERCAP - general purpose	AVX
C13	10 $\mu$ F	1210	25 V-X7R CERCAP - gen. purpose - X7R - 20%	TDK
C15	4.7 nF	0805	50 V CERCAP - general purpose - X7R - 10%	KEMET
C16	220 pF	0805	50 V CERCAP - general purpose - C0G - 5%	KEMET
C17	4.7 $\mu$ F	7.8 x 7.8 p. 5	63 V - MKT film cap. - B32529D0475M000	EPCOS
C18	4.7 $\mu$ F	7.8 x 7.8 p. 5	63 V - MKT film cap. - B32529D0475M000	EPCOS
C19	100 nF	0805	100 V CERCAP - general purpose - X7R - 10%	AVX
C2	470 nF - X2	9 x 18.0 p.15 mm	X2 - MKP film cap. - B32922C3474K	EPCOS
C20	15 nF	5 x 18 p.15 mm	1000 V - MKP film cap. - B32652A0153K000	EPCOS
C21	220 nF	0805	16 V CERCAP - general purpose - X7R - 10%	Murata
C22	100 nF	1206	50 V CERCAP - general purpose - X7R - 10%	KEMET
C24	4.7 $\mu$ F	0805	6.3 V CERCAP - general purpose - X5R - 10%	EPCOS
C25	470 pF	0805	50 V CERCAP - general purpose - COG - 5%	EPCOS
C26	4.7 nF	0805	50 V CERCAP - general purpose - X7R - 10%	KEMET
C27	220 nF	0805	50 V CERCAP - general purpose - X7R - 10%	Murata
C3	470 nF - X2	9 x 18.0 p.15 mm	X2 - MKP film cap. - B32922C3474K	EPCOS
C30	10 $\mu$ F	1210	25 V CERCAP - general purpose - X7R - 20%	TDK
C31	220 nF	0805	16 V CERCAP - general purpose - X7R - 10%	Murata
C32	220 nF	0805	16 V CERCAP - general purpose - X7R - 10%	Murata
C33	10 nF	0805	50 V CERCAP - general purpose - X7R - 10%	KEMET
C34	220 pF	1206	1 KV high voltage CERCAP - X7R - 10%	AVX
C35	220 nF	0805	16 V CERCAP - general purpose - X7R - 10%	Murata
C36	N. M.	0805	Not mounted	
C37	N. M.	0805	Not mounted	
C38	N. M.	0805	Not mounted	

Table 4. STEVAL-ILL053V1 evaluation board: bill of material (continued)

Des.	Part type / part value	Case style / package	Description	Supplier
C39	470 nF	0805	25 V CERCAP - general purpose - X7R - 10%	KEMET
C4	470 nF	9 x 18.0 p.15 mm	X2 - MKP film cap. -B32922C3474K	EPCOS
C40	10 µF	2220	50 V - CERCAP - general purpose - X7R - 20%	TDK
C41	N. M.	0805	Not mounted	
C5	5 µF	14 x 31.5 p. 27.5 mm	800 V - MKP film cap. - B32774D8505K000	EPCOS
C6	5 µF	14 x 31.5 p. 27.5 mm	800 V - MKP film cap. - B32774D8505K000	EPCOS
C7	5 µF	14 x 31.5 p. 27.5mm	800 V - MKP film cap. - B32774D8505K000	EPCOS
C8	2.2 nF - Y1	4.5 x 12 p.10 mm	Y1 safety cap. DE1E3KX222M	Murata
C9	10 nF	1206	100 V CERCAP - gen. purpose - X7R - 10%	KEMET
D1	1.4007 nF	DO-41	General purpose rectifier	VISHAY®
D10	N. M.	SOD-80	Zener diode	
D11	STPS10150CG	D2PAK	Power Schottky rectifier	STMicroelectronics
D12	STPS10150CG	D2PAK	Power Schottky rectifier	STMicroelectronics
D13	LL4148	SOD-80	Fast switching diode	VISHAY
D14	LL4148	SOD-80	Fast switching diode	VISHAY
D15	BZV55-B24	SOD-80	Zener diode	VISHAY
D16	LL4148	SOD-80	Fast switching diode	VISHAY
D17	BZV55-B24	SOD-80	Zener diode	VISHAY
D18	LL4148	SOD-80	Fast switching diode	VISHAY
D19	LL4148	SOD-80	Fast switching diode	VISHAY
D2	STTH3L06U	SMB	Ultrafast high voltage rectifier	STMicroelectronics
D20	STPS1L60A	SMA	Fast switching diode	STMicroelectronics
D21	BZV55-B24	SOD-80	Zener diode	VISHAY
D22	BZV55-B24	SOD-80	Zener diode	VISHAY
JPX9 /D23	Jumper		Wire jumper	
D24	LL4149	SOD-81	Fast switching diode	VISHAY
D3	GBU8J	STYLE GBU - DWG	Single phase bridge rectifier	VISHAY
D4	LL4148	SOD-80	Fast switching diode	VISHAY
D5	LL4148	SOD-80	Fast switching diode	VISHAY

Table 4. STEVAL-ILL053V1 evaluation board: bill of material (continued)

Des.	Part type / part value	Case style / package	Description	Supplier
D6	LL4148	SOD-80	Fast switching diode	VISHAY
D7	BZV55-B15	SOD-80	Zener diode	VISHAY
D8	LL4148	SOD-80	Fast switching diode	VISHAY
D9	LL4148	SOD-80	Fast switching diode	VISHAY
F1	FUSE T4A	8.5 x 4 p. 5.08 mm	Fuse 4 A - time lag - 3921400	LITTLEFUSE
HS1	Heatsink	DWG	Heatsink for D3 and Q2	
J1	MKDS 1,5 / 3-5,08	p. 5.08 mm	PCB term. block, screw conn., pitch 5 MM - 3 W.	PHOENIX CONTACT
J2	MKDS 1,5 / 2-5,08	p. 5.08 mm	PCB term. block, screw conn., pitch 5 MM - 2 W.	PHOENIX CONTACT
L1	1975.0001	DWG	PFC choke - 520 $\mu$ H PQ26/25	MAGNETICA
L2	12 mH	DWG	CM filter 2019.0002	MAGNETICA
L3	3.3 $\mu$ H - 4.7 A	DIA. 7.7 p. 5 mm	Inductor 1071.0080	MAGNETICA
Q1	BC846C	SOT-23	NPN small signal BJT	VISHAY
Q2	STF22NM60N	TO220	N-channel Power MOSFET	STMicroelectronics
Q3	N. M.	SOT-23	PNP small signal BJT	
Q4	STD10NM60N	DPAK	N-channel Power MOSFET	STMicroelectronics
Q5	STD10NM60N	DPAK	N-channel Power MOSFET	STMicroelectronics
Q6	BC846C	SOT-23	NPN small signal BJT	VISHAY
Q7	BC846C	SOT-23	NPN small signal BJT	VISHAY
Q8	BC846C	SOT-23	NPN small signal BJT	VISHAY
R1	N. M.	0805	Not mounted	
R10	1.2 M $\Omega$	1206	SMD standard film res. - 1/4 W - 1% - 100 ppm / $^{\circ}$ C	VISHAY
R11	4.7 K $\Omega$	1206	SMD standard film res. - 1/4 W - 5% - 250 ppm / $^{\circ}$ C	VISHAY
R12	2.0 M $\Omega$	1206	SMD standard film res. - 1/4 W - 5% - 250 ppm / $^{\circ}$ C	VISHAY
R13	120 K $\Omega$	1206	SMD standard film res. - 1/4 W - 5% - 250 ppm / $^{\circ}$ C	VISHAY
R14	390 K $\Omega$	1206	SMD standard film res. - 1/4 W - 5% - 250 ppm / $^{\circ}$ C	VISHAY
R15	39 K $\Omega$	0805	SMD standard film res. - 1/8 W - 1% - 100 ppm / $^{\circ}$ C	VISHAY
R16	39 K $\Omega$	0805	SMD standard film res. - 1/8 W - 1% - 100 ppm / $^{\circ}$ C	VISHAY
R17	0 $\Omega$	1206	SMD standard film res. - 1/4 W - 1% - 100 ppm / $^{\circ}$ C	VISHAY
R18	56 K $\Omega$	1206	SMD standard film res. - 1/4 W - 5% - 250 ppm / $^{\circ}$ C	VISHAY
R19	0 $\Omega$	0805	SMD standard film res. - 1/8 W - 1% - 100 ppm / $^{\circ}$ C	VISHAY
R2	1 M $\Omega$	1206	SMD standard film res. - 1/4 W - 1% - 100 ppm / $^{\circ}$ C	VISHAY
R20	120 K $\Omega$	0805	SMD standard film res. - 1/8 W - 5% - 250 ppm / $^{\circ}$ C	VISHAY
R21	33 $\Omega$	0805	SMD standard film res. - 1/8 W - 5% - 250 ppm / $^{\circ}$ C	VISHAY



Table 4. STEVAL-ILL053V1 evaluation board: bill of material (continued)

Des.	Part type / part value	Case style / package	Description	Supplier
R22	39 K $\Omega$	0805	SMD standard film res. - 1/8 W - 5% - 250 ppm / °C	VISHAY
R23	100 $\Omega$	0805	SMD standard film res. - 1/8 W - 5% - 250 ppm / °C	VISHAY
R24	1.4 M $\Omega$	1206	SMD standard film res. - 1/4 W - 1% - 100 ppm / °C	VISHAY
R25	82 K $\Omega$	0805	SMD standard film res. - 1/8 W - 1% - 100 ppm / °C	VISHAY
R26	15 K $\Omega$	0805	SMD standard film res. - 1/8 W - 1% - 100 ppm / °C	VISHAY
R27	470 $\Omega$	0805	SMD standard film res. - 1/8 W - 5% - 250 ppm / °C	VISHAY
R29	N. M.	1206	Not mounted	
R3	10 $\Omega$	1206	SMD standard film res. - 1/4 W - 5% - 250 ppm / °C	VISHAY
R30	0 $\Omega$	1206	SMD standard film res. - 1/8 W - 1% - 100 ppm / °C	VISHAY
R31	0 $\Omega$	1206	SMD standard film res. - 1/8 W - 1% - 100 ppm / °C	VISHAY
R32	270 K $\Omega$	0805	SMD standard film res. - 1/8 W - 5% - 250 ppm / °C	VISHAY
R33	0.39 $\Omega$	2010	SMD standard film res. - 1/2 W - 5% - 250 ppm / °C	VISHAY
R34	0.39 $\Omega$	2010	SMD standard film res. - 1/2 W - 5% - 250 ppm / °C	VISHAY
R36	4.7 K $\Omega$	0805	SMD standard film res. - 1/8 W - 5% - 250 ppm / °C	VISHAY
R37	6.8 K $\Omega$	1206	SMD standard film res. - 1/4 W - 5% - 250 ppm / °C	VISHAY
R38	2.2 M $\Omega$	0805	SMD standard film res. - 1/8 W - 5% - 250 ppm / °C	VISHAY
R39	51 $\Omega$	0805	SMD standard film res. - 1/8 W - 5% - 250 ppm / °C	VISHAY
R4	1.2 M $\Omega$	1206	SMD standard film res. - 1/4 W - 1% - 100 ppm / °C	VISHAY
R41	4.7 K $\Omega$	1206	SMD standard film res. - 1/4 W - 5% - 250 ppm / °C	VISHAY
R42	10 K $\Omega$	0805	SMD standard film res. - 1/8 W - 1% - 100 ppm / °C	VISHAY
R43	10 K $\Omega$	1206	SMD standard film res. - 1/4 W - 5% - 250 ppm / °C	VISHAY
R44	N. M.	0805	SMD standard film res. - 1/8 W - 5% - 250 ppm / °C	
R45	220 K $\Omega$	1206	SMD standard film res. - 1/4 W - 5% - 250 ppm / °C	VISHAY
R46	51 $\Omega$	1206	SMD standard film res. - 1/4 W - 5% - 250 ppm / °C	VISHAY
R47	220 K $\Omega$	1206	SMD standard film res. - 1/4 W - 5% - 250 ppm / °C	VISHAY
R49	0 $\Omega$	0805	SMD standard film res. - 1/8 W - 5% - 250 ppm / °C	VISHAY
R5	120 K $\Omega$	1206	SMD standard film res. - 1/4 W - 5% - 250 ppm / °C	VISHAY
R50	10 K $\Omega$	0805	SMD standard film res. - 1/8 W - 5% - 250 ppm / °C	VISHAY
R51	N. M.	0805	Not mounted	
R52	10 $\Omega$	0805	SMD standard film res. - 1/8 W - 5% - 250 ppm / °C	VISHAY
R53	100 R $\Omega$	1206	SMD standard film res. - 1/4 W - 5% - 250 ppm / °C	VISHAY
R54	2.2 K $\Omega$	0805	SMD standard film res. - 1/8 W - 5% - 250 ppm / °C	VISHAY
R55	470 $\Omega$	0805	SMD standard film res. - 1/8 W - 5% - 250 ppm / °C	VISHAY
R56	N. M.	0805	Not mounted	

Table 4. STEVAL-ILL053V1 evaluation board: bill of material (continued)

Des.	Part type / part value	Case style / package	Description	Supplier
R57	100 $\Omega$	0805	SMD standard film res.- 1/8 W - 5% - 250 ppm / °C	VISHAY
R58	150 K $\Omega$	0805	SMD standard film res. - 1/8 W - 1% - 100 ppm / °C	VISHAY
R59	1.5 $\Omega$	1206	SMD standard film res. - 1/4 W - 5% - 250 ppm / °C	VISHAY
R6	1.0 M $\Omega$	1206	SMD standard film res.- 1/4 W - 1% - 100 ppm / °C	VISHAY
R60	8.2 K $\Omega$	0805	SMD standard film res.- 1/8 W - 1% - 100 ppm / °C	VISHAY
R61	N. M.	1206	Not mounted	
R62	100 K $\Omega$	0805	SMD standard film res. - 1/8 W - 5% - 250 ppm / °C	VISHAY
R7	2.0 M $\Omega$	1206	SMD standard film res. - 1/4W - 5% - 250 ppm/ °C	VISHAY
R8	120 K $\Omega$	1206	SMD standard film res. - 1/4 W - 5% - 250 ppm / °C	VISHAY
R9	1.5 M $\Omega$	1206	SMD standard film res. - 1/4 W - 1% - 100 ppm / °C	VISHAY
RV1	300 V <sub>AC</sub>	dia. 15 x 5 p. 7.5 mm	300 V metal oxide varistor - B72214S0301K101	EPCOS
RX1	0 $\Omega$	1206	SMD standard film res. - 1/4 W - 5% - 250 ppm / °C	VISHAY
RX2	0 $\Omega$	1206	SMD standard film res. - 1/4 W - 5% - 250 ppm / °C	VISHAY
T1	1860.0013	DWG - ETD34	Resonant power transformer	MAGNETICA
U1	L6562ATD	SO-8	TM PFC controller	STMicroelectronics
U2	L6599ATD	SO-16	Improved HV resonant controller	STMicroelectronics
U3	SFH617A-2X009	SMD4 - 10.16 mm	Optocoupler	VISHAY
U4	SEA05 - N. M.	SOT-23-6L	CC/CV controller – not mounted	STMicroelectronics
U5	TS2431AILT	SOT-23	Programmable shunt voltage reference	STMicroelectronics
Z1	PCB rev. 0.2			

## 8 PFC coil specifications

### General description and characteristics

- Application type: consumer, home appliance
- Transformer type: open
- Coil former: vertical type, 6 + 6 pins
- Max. temp. rise: 45 °C
- Max. operating ambient temperature: 60 °C
- Mains insulation: N. A.
- Unit finishing: varnished

### Electrical characteristics

- Converter topology: boost, transition mode
- Core type: PQ26/25-PC44 or equivalent
- Min. operating frequency: 30 kHz
- Typical operating frequency: 120 kHz
- Primary inductance: 0.52 mH  $\pm$  10% at 1 kHz - 0.25 V, measured between pins #5 and #9
- Peak primary current: 4.3 Apk
- RMS primary current: 1.8 A<sub>RMS</sub>

### Electrical diagram and winding characteristics

Figure 37. PFC coil electrical diagram

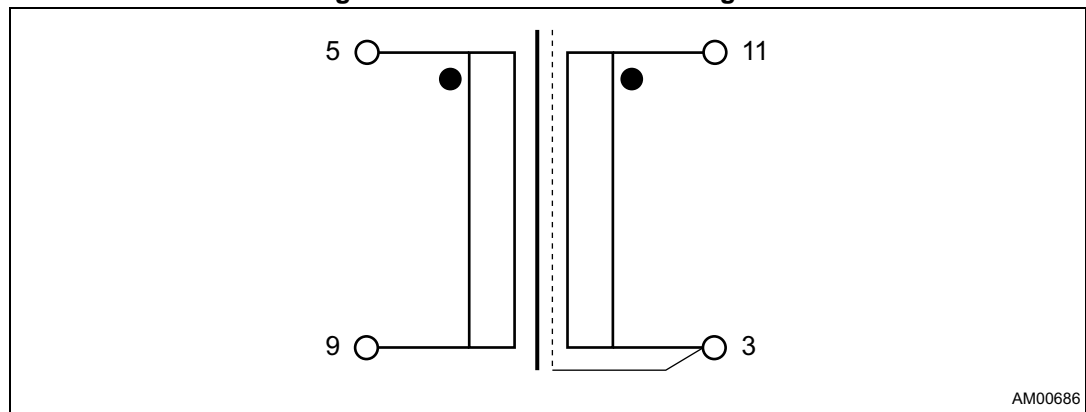


Table 5. PFC coil winding data

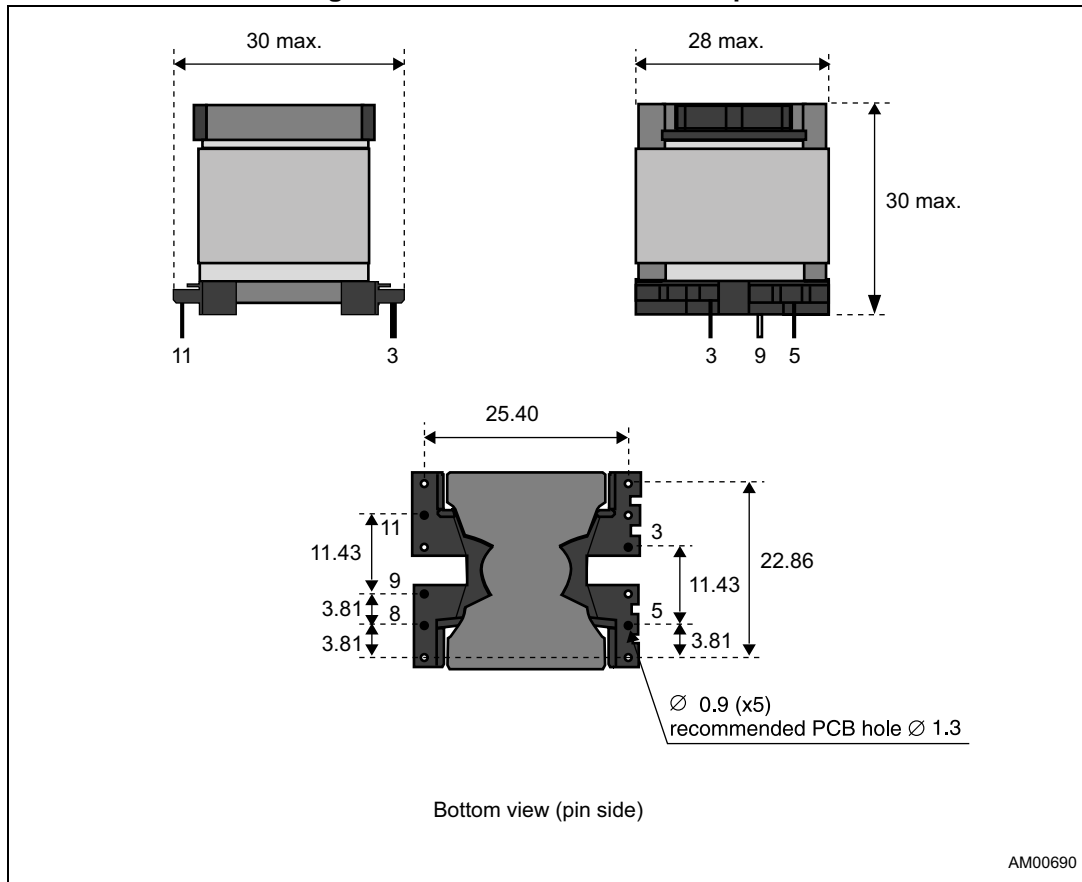
Pins	Windings	Number of turns	Wire type
11 - 3	Aux.	6	0.28 mm - G2
5 - 9	Primary	62	Multistrand #7x 0.28 mm - G2

- Primary winding external insulation: 2 layers of polyester tape
- Aux. winding is wound on top of primary winding
- External insulation: 2 layers of polyester tape
- Wire connected to pin 5 is insulated by sleeve

**Mechanical aspect and pin numbering**

- Maximum height from PCB: 29 mm
- Coil former type: vertical, 6 + 6 pins (pins #1, 2, 4, 6, 7, 10, 12 are removed)
- Pin distance: 3.81 mm
- Row distance: 25 mm
- Coil former P/N: TDK BPQ26/25-1112CP
- External copper shield: not insulated, wound around the ferrite core and including the coil former. Height is 8 mm. Connected to pin #3 by a soldered solid wire.

Figure 38. PFC coil mechanical aspect



1. Quotes are in millimeters, drawing is not to scale.

**Manufacturer**

- MAGNETICA di R. Volpini - Italy ([www.magneticait.it](http://www.magneticait.it))
- Inductor P/N: 1975.0001.

## 9 Transformer specifications

### General description and characteristics

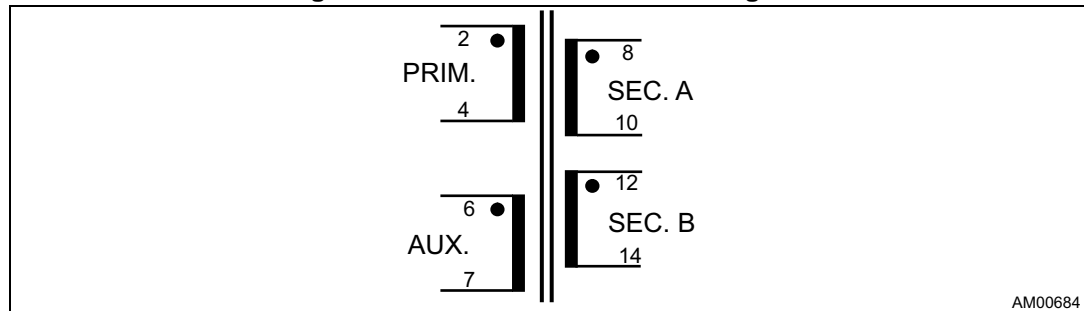
- Application type: consumer, home appliance
- Transformer type: open
- Coil former: horizontal type, 7 + 7 pins, two slots
- Max. temp. rise: 45 °C
- Max. operating ambient temperature: 60 °C
- Mains insulation: acc. with EN60950

### Electrical characteristics

- Converter topology: half-bridge, resonant
- Core type: ETD34-PC44 or equivalent
- Min. operating frequency: 70 kHz
- Typical operating frequency: 100 kHz
- Primary inductance: 770  $\mu\text{H} \pm 15\%$  at 1 kHz - 0.25 V<sup>(a)</sup>
- Leakage inductance: 170  $\mu\text{H}$  at 100 kHz - 0.25 V<sup>(b)</sup>

### Electrical diagram and winding characteristics

Figure 39. Transformer electrical diagram



AM00684

Table 6. Transformer winding data

Pins	Winding	RMS current	Number of turns	Wire type
2-4	Primary	1 A <sub>RMS</sub>	47	#30 x 0.1 mm - G2
8-10	Sec. - A <sup>(1)</sup>	0.05 A <sub>RMS</sub>	9	#60 x 0.1 mm - G2
12-14	Sec. - B <sup>(1)</sup>	2.2 A <sub>RMS</sub>	9	#60 x 0.1 mm - G2
6-7	Aux. <sup>(2)</sup>	2.2 A <sub>RMS</sub>	3	0.28 mm - G2

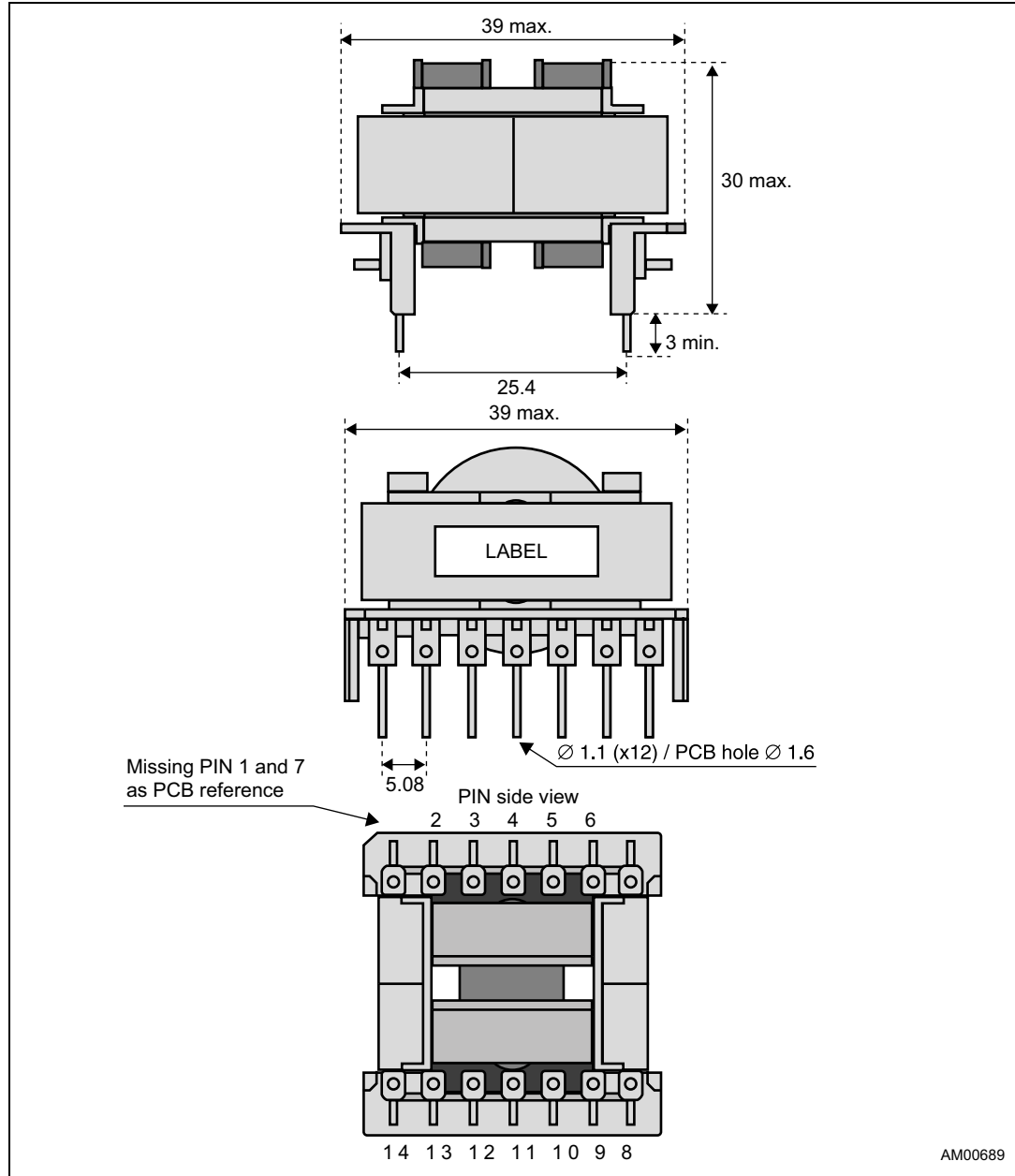
1. Secondary windings A and B have to be wound in parallel.
2. Aux. winding is wound on top of primary winding, turns are close each other, placed on external side of the coil former.

- a. Measured between pins 2-4.
- b. Measured between pins 2-4 with only one secondary winding shorted. Difference between the two measured leakage inductances has to be < 10%.

**Mechanical aspect and pin numbering**

- Maximum height from PCB: 30 mm
- Coil former type: horizontal, 7 + 7 pins (pins #1, #3 and #5 removed for PCB reference)
- Pin distance: 5.08 mm
- Row distance: 25.4 mm

**Figure 40. Transformer mechanical aspect**



1. Quotes are in millimeters, drawing is not to scale.

**Manufacturer**

- MAGNETICA di R. Volpini - Italy ([www.magneticait.it](http://www.magneticait.it))
- Transformer P/N: 1860.0013.



## 10 Revision history

**Table 7. Document revision history**

Date	Revision	Changes
01-Sep-2010	1	Initial release.
28-Sep-2012	2	– Modified: Figure 2 – Modified: Table 4 – Minor text changes to improve readability
13-May-2016	3	– Updated: <a href="#">Figure 1</a> on the cover page

**IMPORTANT NOTICE – PLEASE READ CAREFULLY**

STMicroelectronics NV and its subsidiaries ("ST") reserve the right to make changes, corrections, enhancements, modifications, and improvements to ST products and/or to this document at any time without notice. Purchasers should obtain the latest relevant information on ST products before placing orders. ST products are sold pursuant to ST's terms and conditions of sale in place at the time of order acknowledgement.

Purchasers are solely responsible for the choice, selection, and use of ST products and ST assumes no liability for application assistance or the design of Purchasers' products.

No license, express or implied, to any intellectual property right is granted by ST herein.

Resale of ST products with provisions different from the information set forth herein shall void any warranty granted by ST for such product.

ST and the ST logo are trademarks of ST. All other product or service names are the property of their respective owners.

Information in this document supersedes and replaces information previously supplied in any prior versions of this document.

© 2016 STMicroelectronics – All rights reserved