

Basic Characteristics Data

Model	Circuit method	Switching frequency *2 [kHz]	Input current [A] *1	Rated input fuse	Inrush current protection circuit	PCB/Pattern			Series/Parallel operation availability	
						Material	Single sided	Doubled sided	Series operation	Parallel operation
KHEA30F KHNA30F	Flyback converter	50 - 200	0.55	250V 2.5A	Thermistor	FR-4		Yes	Yes	No
KHEA60F KHNA60F	Flyback converter	50 - 200	1.10	250V 3.15A	Thermistor	FR-4		Yes	Yes	No
KHEA90F KHNA90F	Active filter Flyback converter	20 - 500 50 - 200	0.95	250V 3.15A	Thermistor	FR-4		Yes	Yes	No
KHEA120F KHNA120F	Active filter LLC resonant converter	60 - 550 45 - 350	1.2	500VAC/400VDC 5A	Thermistor	FR-4		Yes	Yes	No
KHEA240F KHNA240F	Active filter LLC resonant converter	60 - 550 45 - 350	2.3	500VAC/400VDC 8A	SCR	FR-4		Yes	Yes	No
KHEA480F KHNA480F	Active filter LLC resonant converter	60 - 150 45 - 350	4.6	500VAC/400VDC 16A	Relay	FR-4		Yes	Yes	No

*1 The value of input current is at ACIN 115V and 100%.

*2 Burst operation at light loading, frequency is change by use condition.
Please contact us about detail.

1	Terminal Blocks	KH-16
2	Functions	KH-18
2.1	Input Voltage Range	KH-18
2.2	Inrush Current Limiting	KH-18
2.3	Overcurrent Protection	KH-18
2.4	Peakcurrent Protection	KH-18
2.5	Overvoltage Protection	KH-18
2.6	Thermal Protection	KH-19
2.7	Output Ripple and Ripple Noise	KH-19
2.8	Remote ON/OFF	KH-19
2.9	Output Voltage Adjustment Range	KH-19
2.10	Isolation	KH-19
2.11	Signal Output	KH-19
3	Peak Current	KH-20
4	Series/Parallel Operation	KH-20
4.1	Series Operation	KH-20
4.2	Parallel Operation	KH-20
5	Assembling and Installation Method	KH-21
5.1	Installation Mounting methods	KH-21
5.2	Derating curve depend on input voltage	KH-22
5.3	Derating curve depend on ambient temperature	KH-22
5.4	Derating curve in cold environment	KH-25
5.5	Expected Life and Warranty	KH-25
5.6	Applicable Electric Cable	KH-28
5.7	Others	KH-28
6	Option	KH-28
6.1	Outline of option	KH-28

1 Terminal Blocks

● KHEA30F

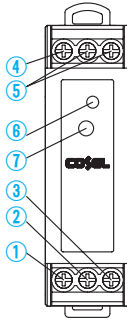

● KHEA60F

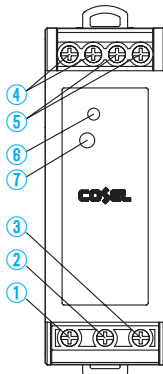

● KHEA90F

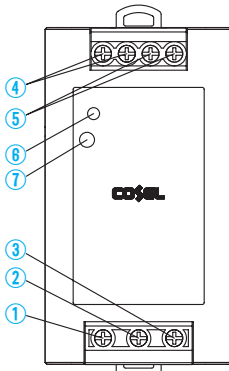

● KHNA30F

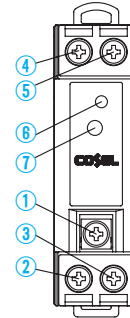

● KHNA60F

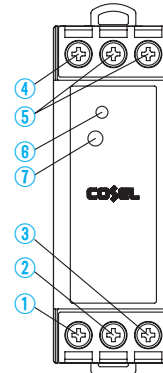

● KHNA90F

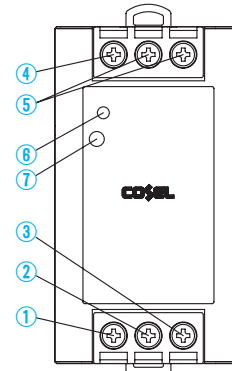

Terminal Number	Terminal Name	Function
①	PE	Protective earth Terminal
②	AC (N)	Input Terminals
③	AC (L)	
④	+VOUT	+Output Terminals
⑤	-VOUT	-Output Terminals
⑥	DC_OK	LED for output voltage confirmation
⑦	TRM	Adjustment of output voltage

● KHEA120F

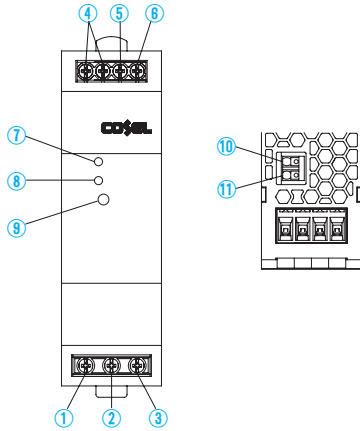

● KHEA240F

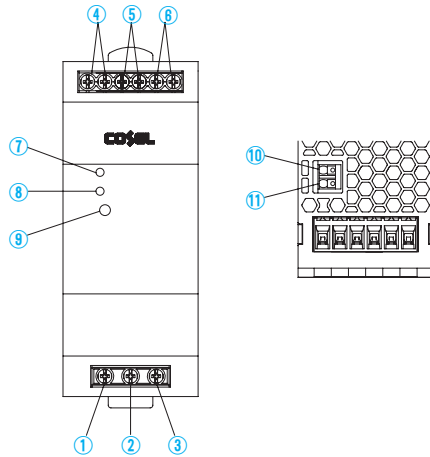

● KHEA480F

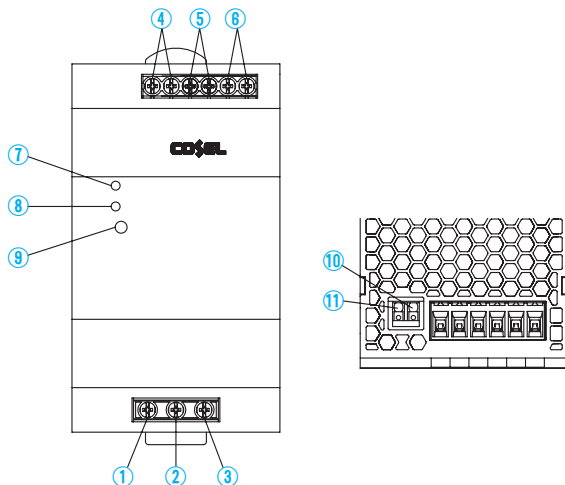

● KHNA120F

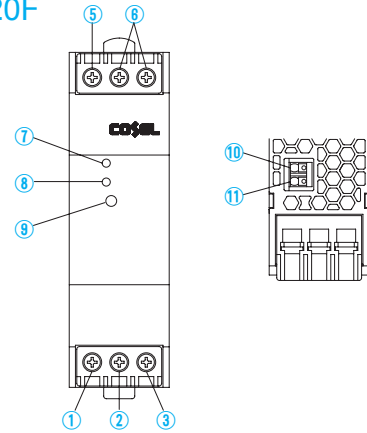

● KHNA240F

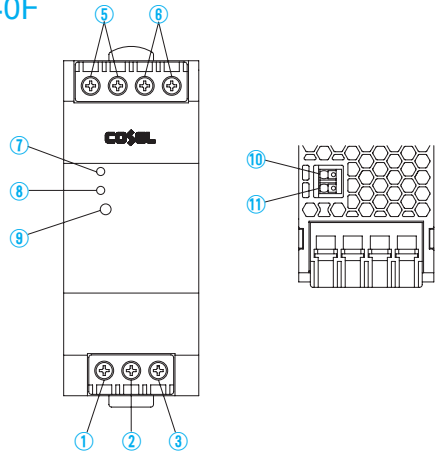

● KHNA480F

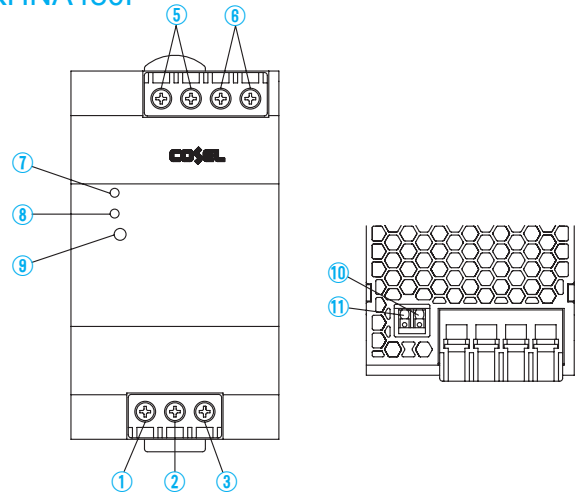

Terminal Number	Terminal Name	Function
①	PE	Protective earth Terminal
②	AC (N)	Input Terminals
③	AC (L)	
④	DC_OK	Output voltage confirmation(relay contact)
⑤	+VOUT	+Output Terminals
⑥	-VOUT	-Output Terminals
⑦	ALARM	LED Alarm for lowered output voltage
⑧	DC_OK	LED for output voltage confirmation
⑨	TRM	Adjustment of output voltage
⑩	+RC	Remote ON/OFF Terminals
⑪	-RC	

2 Functions

2.1 Input Voltage Range

- Input voltage range of the power supplies is from AC85V to AC264V or DC (please see SPECIFICATIONS for details).
- To comply with safety standards, input voltage range is shown in Table 2.1.

Table 2.1 Input voltage range of safety standards

No.	Series	Input Voltage range	
		AC input	DC input
1	KHEA30F, KHNA30F	100V-240V (50/60Hz)	-
2	KHEA60F, KHNA60F		
3	KHEA90F, KHNA90F		
4	KHEA120F, KHNA120F		88V-350V
5	KHEA240F, KHNA240F		
6	KHEA480F, KHNA480F		

- If input value doesn't fall within above range, a unit may not operate in accordance with specifications and/or start hunting or operate protection circuit or fail.
If you need to apply a square waveform input voltage, which is commonly used in UPS and inverters, please contact us.
- When the input voltage changes suddenly, the output voltage accuracy might exceed the specification. Please contact us.

● KHEA30F/60F/90F, KHNA30F/60F/90F

- Operation stop voltage is set at a lower value than of a standard version (derating is needed).
· Use Conditions

	Output
KHEA30F, KHNA30F	10W
KHEA60F, KHNA60F	20W
KHEA90F, KHNA90F	30W

Input AC50V or DC70V
Duty 1s/30s

- *Please avoid using continuously for more than 1 second under above conditions. Doing so may cause a failure.

2.2 Inrush Current Limiting

- An inrush current limiting circuit is built-in.
- If you need to use a switch on the input side, please select one that can withstand an input inrush current.

● KHEA30F/60F/90F/120F, KHNA30F/60F/90F/120F

- Thermistor is used in the inrush current limiting circuit. When you turn the power ON/OFF repeatedly within a short period of time, please have enough intervals so that a power supply cools down before being turned on.

● KHEA240F/480F, KHNA240F/480F

- Thyristor technique (KHEA/KHNA240F) and power relay technique (KHEA/KHNA480F) is used in the inrush current limiting circuit.

- When you turn the power ON/OFF repeatedly within a short period of time, please have enough intervals so that the inrush current limiting circuit becomes operative.
- When the switch of the input is turned on, the primary inrush current and secondary inrush current will be generated.

2.3 Overcurrent Protection

● KHEA30F/60F/90F, KHNA30F/60F/90F

- An overcurrent protection circuit is built-in and activated at 105% of the rated current. A unit automatically recovers when a fault condition is removed. Please do not use a unit in short circuit and/or under an overcurrent condition.
- Intermittent Operation Mode (except KHEA/KHNA90F)
When the overcurrent protection circuit is activated and the output voltage drops to a certain extent, the output becomes intermittent so that the average current will also decrease.
- Output Voltage Shutdown

If the output voltage drops according to the overcurrent protection circuit operating continuously for about 0.5 second, the output voltage may shut down. To recover the output voltage, remove a condition that is causing an overcurrent, shut down the input voltage, wait more than 3 minutes and turn on the AC input again.

● KHEA120F/240F/480F, KHNA120F/240F/480F

- An overcurrent protection circuit is built-in and activated at 101% of the peak current. A unit automatically recovers when a fault condition is removed. Please do not use a unit in short circuit and/or under an overcurrent condition.
- Intermittent Operation Mode
When the overcurrent protection circuit is activated and the output voltage drops to a certain extent, the output becomes intermittent so that the average current will also decrease.

2.4 Peakcurrent Protection

● KHEA120F/240F/480F, KHNA120F/240F/480F

- Peakcurrent protection is built-in (refer to Instruction Manual 3 for Peak loading).
If this function comes into effect, the output is shut down. A few seconds later, A unit automatically recovers.
But if the overcurrent condition has not been released, the output will stop again (intermittent Operation Mode).
- *The recovery time varies depending on input voltage and load condition.

2.5 Overvoltage Protection

● KHEA30F/60F/90F, KHNA30F/60F/90F

- An overvoltage protection circuit is built-in. If the overvoltage protection circuit is activated, shut down the input voltage, wait more than 3 minutes and turn on the AC input again to recover the output voltage. Recovery time varies depending on such factors as input voltage value at the time of the operation.

● KHEA120F/240F/480F, KHNA120F/240F/480F

- An overvoltage protection circuit is built-in.

A unit automatically recovers when the fault condition is removed.

Note :

Please avoid applying a voltage exceeding the rated voltage to an output terminal. Doing so may cause a power supply to malfunction or fail. If you cannot avoid doing so, for example, if you need to operate a motor, etc., please install an external diode on the output terminal to protect the unit.

2.6 Thermal Protection

● KHEA120F/240F/480F, KHNA120F/240F/480F

■ A thermal protection circuit is built-in.

The thermal protection circuit may be activated under the following conditions and shut down the output.

- ① When a temperature continue to exceed the values determined by the derating curve.
- ② When a current exceeding the rated current is applied.
- ③ When convection stops.
- ④ When peak load is applied in conditions other than those shown in Section 3.

A unit automatically recovers when the fault condition is removed.

2.7 Output ripple and ripple noise

■ Output ripple noise may be influenced by measurement environment, measuring method fig 2.1 is recommended.

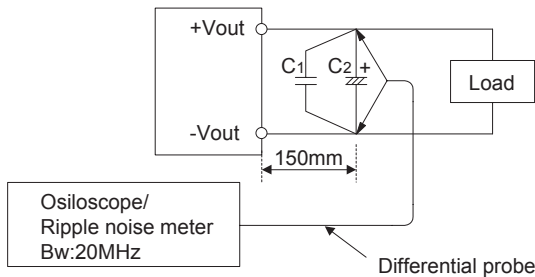

C1:Film capacitor 0.1 μF
C2:Aluminum electrolytic capacitor 22 μF

Fig.2.1 Measuring method of Ripple and Ripple Noise

2.8 Remote ON/OFF

● KHEA120F/240F/480F, KHNA120F/240F/480F

■ You can reduce the standby power by Remote ON/OFF.

To do so, connect an external DC power supply and apply a voltage to a remote ON/OFF connector.

Table 2.2 Remote ON/OFF Specifications

ON/OFF logic	Between +RC and -RC	Output voltage
Negative	L level (0 to 0.5V) or open	ON
	H level (4.5 to 29.5V)	OFF

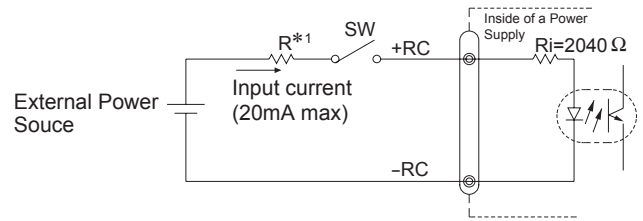

Fig.2.2 Example of use with remote ON/OFF

*1 If the output of an external power supply is within the range of 4.5 - 29.5V, you do not need a current limiting resistor R. If the output exceeds 29.5V, however, please connect the current limiting resistor R.

To calculate a current limiting resistance value, please use the following equation.

$$R [\Omega] = \frac{V_{cc} - (1.1 + R_i \times 0.005)}{0.005}$$

- Please wire carefully. If you wire wrongly, the internal components of a unit may be damaged.
- Remote ON/OFF circuits (+RC and -RC) are isolated from input, output and PE.
- Restart time is 750 ms max .

2.9 Output Voltage Adjustment Range

■ To increase an output voltage, turn a built-in potentiometer clockwise. To decrease the output voltage, turn it counterclockwise.

2.10 Isolation

- When you run a Hi-Pot test as receiving inspection, gradually increase the voltage to start. When you shut down, decrease the voltage gradually by using a dial. Please avoid a Hi-Pot tester with a timer because, when the timer is turned ON or OFF, it may generate a voltage a few times higher than the applied voltage.
- When you test a unit for isolation between the output and the DC_OK, short all terminals of DC_OK.

2.11 Signal Output

Functions of LED indicators and signal output (KHEA series)

● KHEA120F/240F/480F, KHNA120F/240F/480F

■ Functions of LED indicators and signal output in the form of relay contact are shown below. Checking the presence/absence of voltage at the output terminal of a power supply is possible.

Table 2.3 Description of the signal output

Signal Output	Normal	Output is decreasing
DC_OK (LED: Green)	ON	OFF
ALARM (LED: Red)	OFF	ON
DC_OK (Relay Contact) *	Short	Open

*DC_OK signal (relay contact) is built in KHEA series. This circuit is insulated from other circuits (input and output circuits).

Caution on signal outputs :

■ The timing of signals might be very depending on models, input and load conditions. Please make sure enough evaluation.

3 Peak Current

● KHEA120F/240F/480F, KHNA120F/240F/480F

■ The units can generate the peak current under the following conditions.

- $t_1 \leq 5\text{sec}$
- $I_p \leq \text{Rated peak current}$
- $I_{ave} \leq \text{Rated current}$

* Please use a maximum of Duty following shown in Table 3.1.

$$\text{Duty} = \frac{t_1}{t_1 + t_2} \times 100 [\%]$$

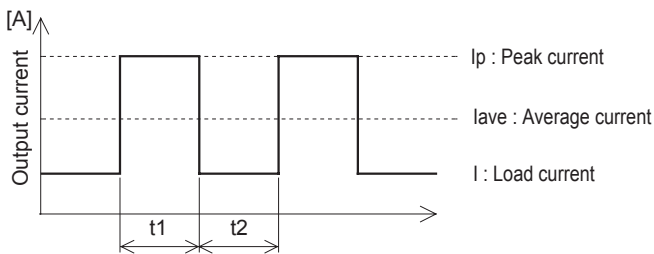

Fig.3.1 Peak current

Table 3.1 Maximum Duty by the mounting orientation

Mounting orientation	Input Voltage	Maximum Duty			
		KHEA120F KHNA120F	KHEA240F KHNA240F	KHEA480F-24 KHNA480F-24	KHEA480F-48 KHNA480F-48
A	AC85 - 170V AC170 - 264V	35%	35%	20%	20%
B	AC85 - 264V			20%	15%
C	AC85 - 264V			5%	
D	AC85 - 264V				
E	AC85 - 264V			20%	

4 Series/Parallel Operation

4.1 Series Operation

■ You can use a power supply in series operation. The output current in series operation should be lower than the rated current of a power supply with the lowest rated current among the power supplies that are serially connected. Please make sure that no current exceeding the rated current flows into a power supply.

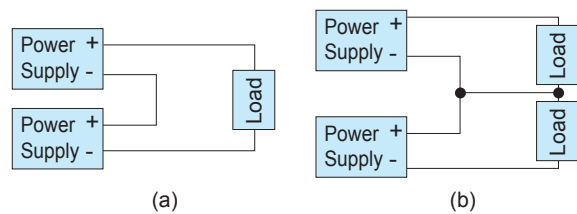

Fig.4.1 Examples of connecting in series operation

4.2 Parallel Operation

■ There is no current balance function.

When operating in parallel, such as diode-OR, please use on the output voltage was adjusted enough to balance the current.

Exceeds the rated output current, the output is shut down.

■ Redundancy operation is available by wiring as shown below.

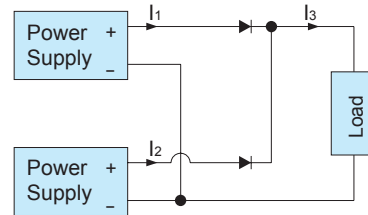

Fig.4.2 Example of connecting in redundancy operation

Even a slight difference in output voltage can affect the balance between the values of I_1 and I_2 .

Please make sure that the value of I_3 does not exceed the rated current of a power supply.

$$I_3 \leq \text{rated current value}$$

5 Assembling and Installation Method

5.1 Installation Mounting methods

■ About DIN-Rail

Attachment available with DIN EN60715 TH 35 (35×7.5mm or 35×15mm) (Top hat shaped DIN rail)

■ Below shows mounting orientation.

If install other than standard mounting orientation (A), please fix the power supply for withstand the impact and vibration.

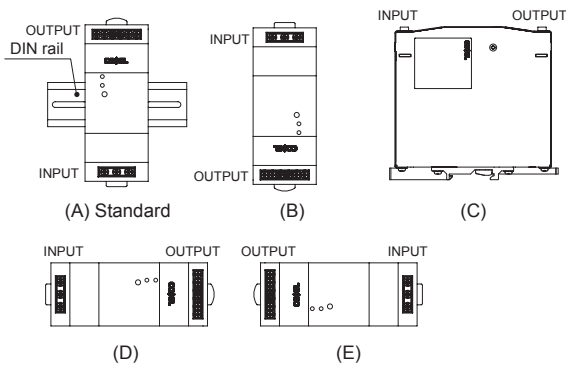

Fig.5.1 Mounting orientation

■ When you mount a power supply on a DIN rail, have the area marked A catch one side of the rail and push the unit to the direction of B. To remove the power supply from the rail, either push down the area marked C or insert a tool such as driver to the area marked D and pull the unit apart from the rail.

When you couldn't remove the unit easily, push down the area marked C while lightly pushing the unit to the direction of E.

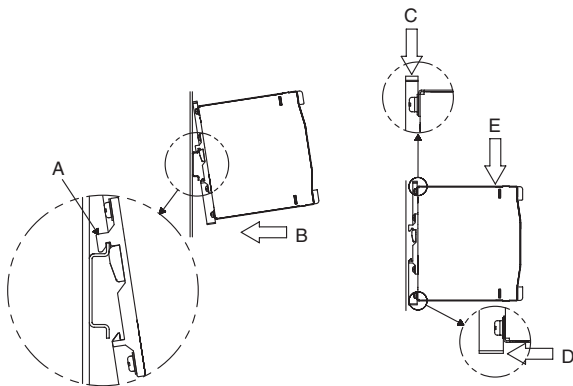

Fig.5.2 Installation method

■ Shown below the notes about installation clearance of a unit.

● **KHEA30F/60F/90F, KHNA30F/60F/90F**

① Installation clearance at above and below the unit.

Please have clearance of at least 25mm above and below the unit to avoid heat accumulation.

② Installation clearance at the side of the unit.

Please have clearance of at least 5mm side the unit to insulating the internal components. However, refer to Table 5.1, if adjacent device of the unit (including power supply) is a heat source.

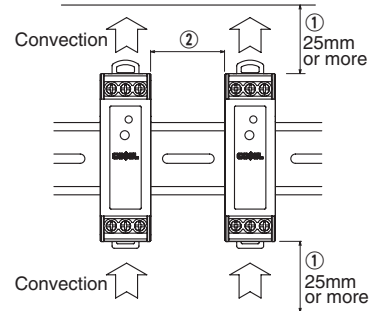

Fig.5.3 Installation clearance

Table 5.1 Installation clearance at the side of the unit.

No.	Model	Adjacent device of the unit	
		Non-heat source	Heat source(*)
1	KHEA30F, KHNA30F	5mm or more	15mm or more
2	KHEA60F, KHNA60F	5mm or more	15mm or more
3	KHEA90F, KHNA90F	5mm or more	15mm or more

* Reference value when same power units are adjacent.

● **KHEA120F/240F/480F, KHNA120F/240F/480F**

① Installation clearance at above and below the unit.

Please have clearance of at least 25mm above and below the unit to avoid heat accumulation.

② Installation clearance at the side of the unit.

Please have clearance of at least 15mm side the unit to avoid interfering with heat radiation from housing. However, refer to Table 5.2, if adjacent device of the unit (including power supply) is a heat source.

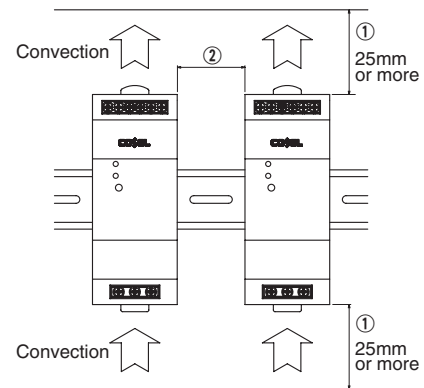

Fig.5.4 Installation clearance

Table 5.2 Installation clearance at the side of the unit.

No.	Model	Adjacent device of the unit	
		Non-heat source	Heat source(*)
1	KHEA120F, KHNA120F	15mm or more	
2	KHEA240F, KHNA240F	15mm or more	
3	KHEA480F, KHNA480F	15mm or more	50mm or more

* Reference value when same power units are adjacent.

5.2 Derating curve depend on input voltage

● KHEA30F/60F/90F, KHNA30F/60F/90F

■ Derating curve depend on input voltage.
 Derating curve depend on input voltage is shown in Fig.5.5.

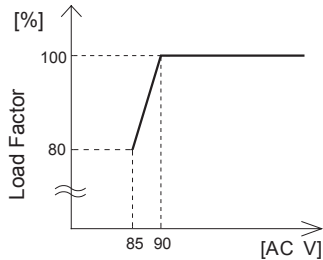

Fig.5.5 Derating curve depend on input voltage

● KHEA480F, KHNA480F

■ Derating curve depend on input voltage.
 Derating curve depend on input voltage is shown in Fig.5.6.

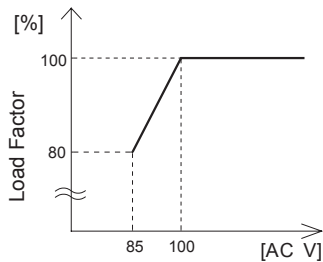
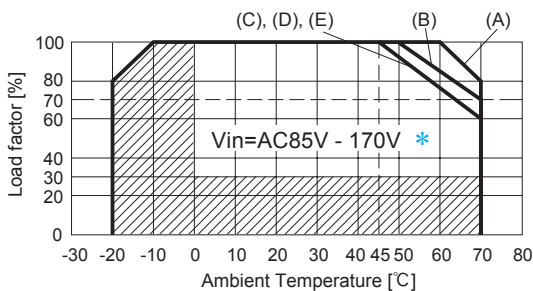

Fig.5.6 Derating curve depend on input voltage

5.3 Derating curve depend on ambient temperature

■ The operative ambient temperature as different by input voltage.
 Derating curve is shown below.
 ■ In the hatched area, the specification of Ripple, Ripple Noise is different from other area.
 ■ Derating Curve (Convection)

● KHEA30F, KHNA30F



* Derating curve depend on input voltage is required.

Fig.5.7 Derating curve depend on ambient temperature

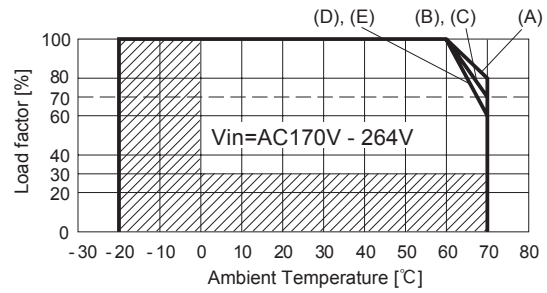
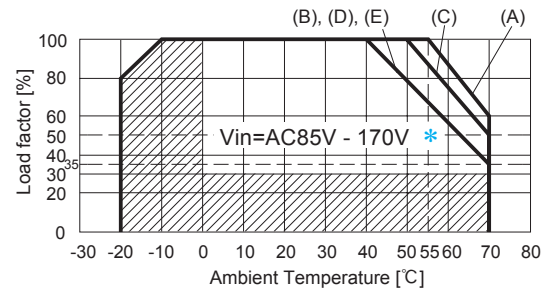

Fig.5.8 Derating curve depend on ambient temperature

● KHEA60F, KHNA60F



* Derating curve depend on input voltage is required.

Fig.5.9 Derating curve depend on ambient temperature

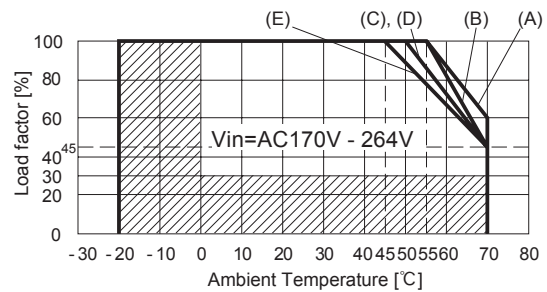
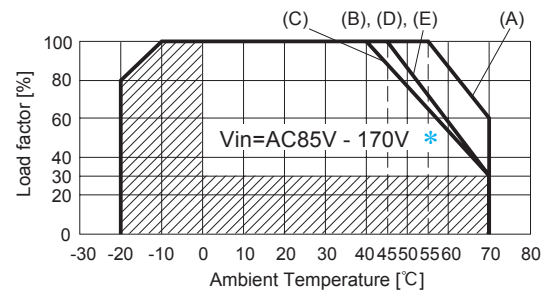

Fig.5.10 Derating curve depend on ambient temperature

● KHEA90F, KHNA90F



* Derating curve depend on input voltage is required.

Fig.5.11 Derating curve depend on ambient temperature

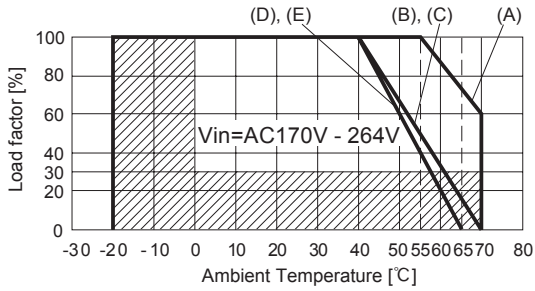

Fig.5.12 Derating curve depend on ambient temperature

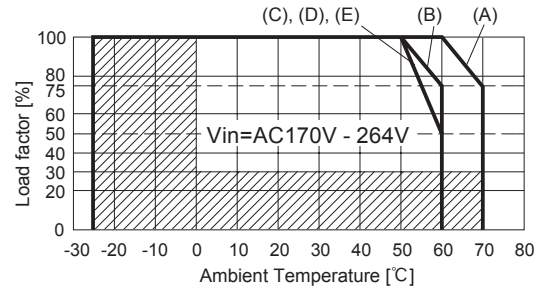

Fig.5.16 Derating curve depend on ambient temperature

● KHEA120F, KHNA120F

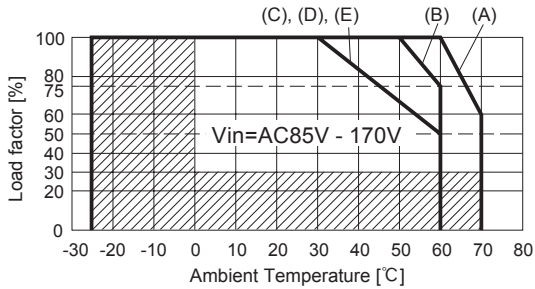
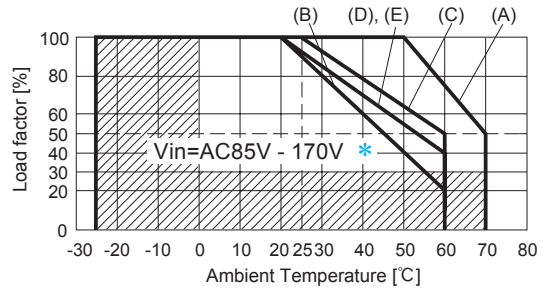

Fig.5.13 Derating curve depend on ambient temperature

● KHEA480F, KHNA480F



* Derating curve depend on input voltage is required.

Fig.5.17 Derating curve depend on ambient temperature

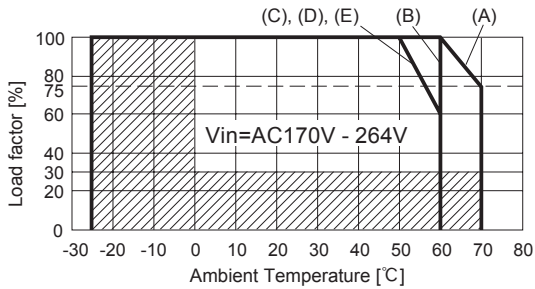

Fig.5.14 Derating curve depend on ambient temperature

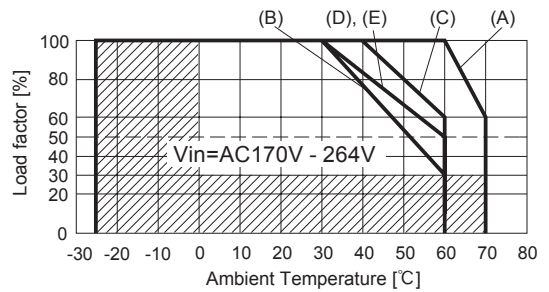

Fig.5.18 Derating curve depend on ambient temperature

● KHEA240F, KHNA240F

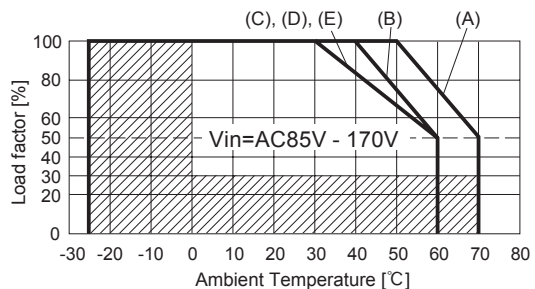

Fig.5.15 Derating curve depend on ambient temperature

■ Ambient temperature indicates the temperature of the inlet of the air.

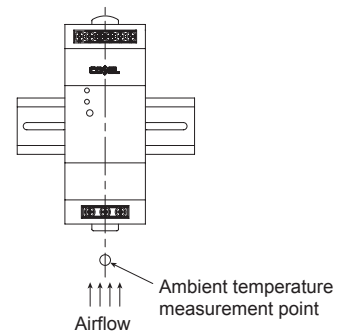

Fig.5.19 Ambient temperature measurement point

● KHEA30F/60F/90F, KHNA30F/60F/90F

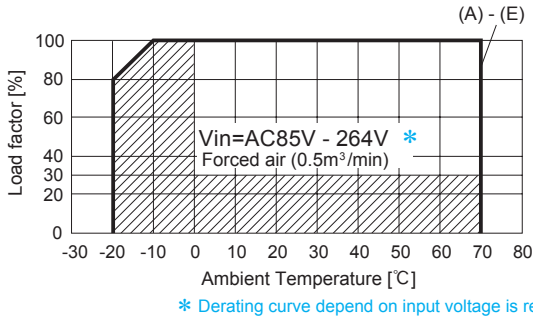

Fig.5.20 Derating curve depend on ambient temperature

■ Temperature of Forced air

Use the temperature measurement point as shown in Fig.5.21 to 5.23. Please use at the temperature dose not exceed the values in Table 5.3. Please also make sure that the ambient temperature does not exceed 70°C.

● KHEA30F, KHNA30F

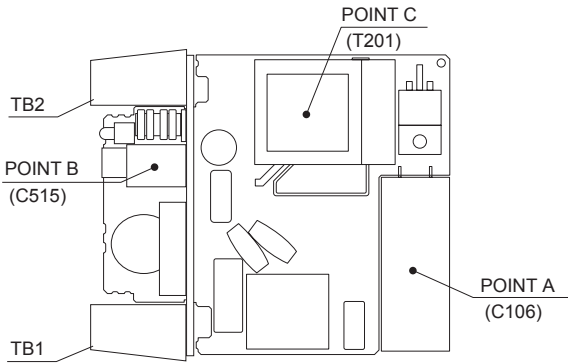

Fig.5.21 Temperature measurement point (Forced air)

● KHEA60F, KHNA60F

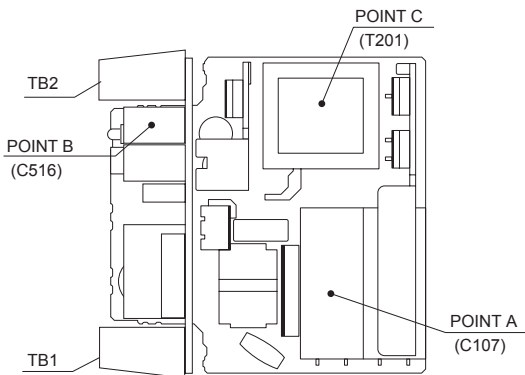
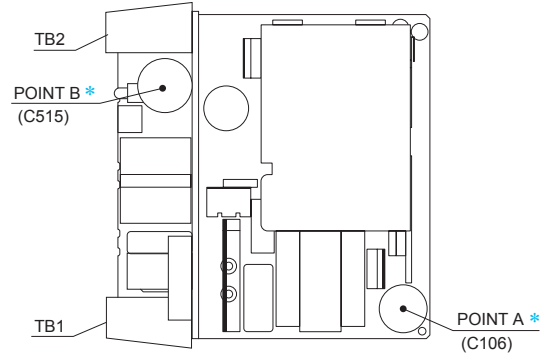

Fig.5.22 Temperature measurement point (Forced air)

● KHEA90F, KHNA90F



* Please be careful of electric shock or earth leakage in case of temperature measurement, because POINT A and POINT B is live potential.

Fig.5.23 Temperature measurement point (Forced air)

Table 5.3 Specified temperature of the measurement point

No.	Model	Temperature measurement point		
		Point A	Point B	Point C
1	KHEA30F, KHNA30F	80°C	80°C	105°C
2	KHEA60F, KHNA60F	80°C	80°C	105°C
3	KHEA90F, KHNA90F	80°C	80°C	

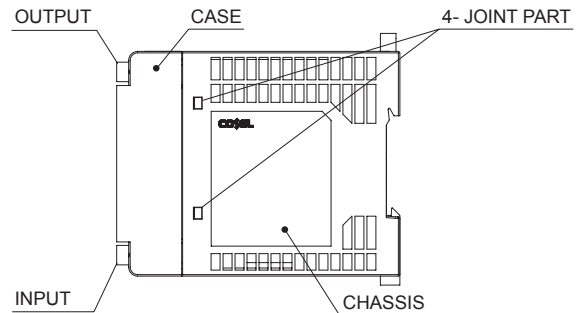

Fig.5.24 Installation removing chassis and case

Thermocouple for temperature checking must be added into temperature measuring point after removing chassis and case.

Then assembling chassis and case again, the temperature can be measured.

Chassis and case are fixed in 4 parts which are shown in the figure. Please contact us about detail.

● KHEA120F/240F, KHNA120F/240F

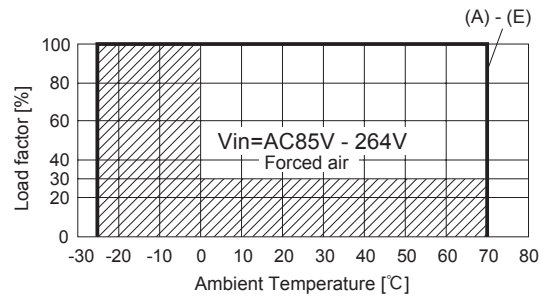
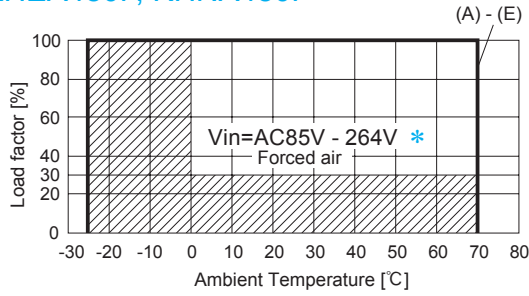

Fig.5.25 Derating curve depend on ambient temperature

● KHEA480F, KHNA480F



* Derating curve depend on input voltage is required.

Fig.5.26 Derating curve depend on ambient temperature

■ Temperature of Forced air

Use the temperature measurement point as shown in Fig 5.27. Please use at the temperature does not exceed the values in Table 5.4. Please also make sure that the ambient temperature does not exceed 70°C.

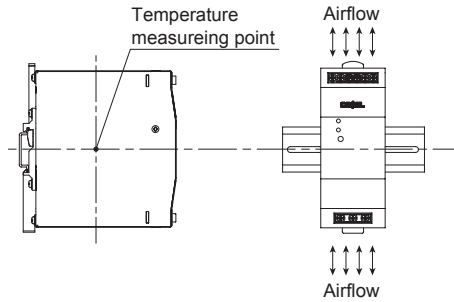

Fig.5.27 Temperature measurement point (Forced air)

Table 5.4 Specified temperature of the measurement point

No.	Model	temperature measurement point
1	KHEA120F, KHNA120F	75°C
2	KHEA240F, KHNA240F	80°C
3	KHEA480F, KHNA480F	85°C

5.4 Derating curve in cold environment

■ Derating curve in cold environment

Derating curve in cold environment is shown in Table.5.5.

Table 5.5 Derating curve in cold environment

No.	Model	temperature range	Load factor
1	KHEA120F, KHNA120F	-25°C to -40°C	75%
2	KHEA240F, KHNA240F		
3	KHEA480F, KHNA480F		

5.5 Expectancy life and warranty

Please note derating curve depend on input voltage is required.

■ Expectancy Life.

Table 5.6 Expectancy Life (KHEA30F, KHNA30F)

Mounting method	Cooling method	Input voltage	Average ambient temperature (year)	Expectancy Life	
				Load factor $Io \leq 75\%$	Load factor $75\% < Io \leq 100\%$
A	Convection	AC85 - 170V	Ta = 50°C or less	10years	7years
			Ta = 60°C	6years	3years
		AC170 - 264V	Ta = 50°C or less	10years	9years
			Ta = 60°C	6years	4years
B	Convection	AC85 - 170V	Ta = 40°C or less	10years	10years
			Ta = 50°C	10years	6years
		AC170 - 264V	Ta = 50°C or less	10years	9years
			Ta = 60°C	6years	4years
C	Convection	AC85 - 170V	Ta = 35°C or less	10years	10years
			Ta = 45°C	10years	7years
		AC170 - 264V	Ta = 50°C or less	10years	6years
			Ta = 60°C	5years	3years
D	Convection	AC85 - 170V	Ta = 35°C or less	10years	10years
			Ta = 45°C	10years	6years
		AC170 - 264V	Ta = 50°C or less	10years	7years
			Ta = 60°C	5years	3years
E	Convection	AC85 - 170V	Ta = 35°C or less	10years	10years
			Ta = 45°C	10years	6years
		AC170 - 264V	Ta = 50°C or less	10years	7years
			Ta = 60°C	5years	3years
A,B,C,D and E	Forced air	AC85 - 264V	Ta = 70°C	5years	3years

Table 5.7 Expectancy Life (KHEA60F, KHNA60F)

Mounting method	Cooling method	Input voltage	Average ambient temperature (year)	Expectancy Life	
				Load factor $Io \leq 75\%$	Load factor $75\% < Io \leq 100\%$
A	Convection	AC85 - 170V	Ta = 45°C or less	10years	5years
			Ta = 55°C	5years	3years
		AC170 - 264V	Ta = 45°C or less	10years	10years
			Ta = 55°C	9years	6years
B	Convection	AC85 - 170V	Ta = 30°C or less	10years	7years
			Ta = 40°C	9years	3years
		AC170 - 264V	Ta = 45°C or less	9years	7years
			Ta = 55°C	5years	3years
C	Convection	AC85 - 170V	Ta = 40°C or less	10years	6years
			Ta = 50°C	7years	3years
		AC170 - 264V	Ta = 40°C or less	10years	10years
			Ta = 50°C	8years	5years
D	Convection	AC85 - 170V	Ta = 30°C or less	10years	5years
			Ta = 40°C	8years	2years
		AC170 - 264V	Ta = 40°C or less	10years	8years
			Ta = 50°C	6years	4years
E	Convection	AC85 - 170V	Ta = 30°C or less	10years	6years
			Ta = 40°C	9years	3years
		AC170 - 264V	Ta = 35°C or less	10years	10years
			Ta = 45°C	10years	7years
A,B,C,D and E	Forced air	AC85 - 264V	Ta = 70°C	5years	3years

Table 5.8 Expectancy Life (KHEA90F, KHNA90F)

Mounting method	Cooling method	Input voltage	Average ambient temperature (year)	Expectancy Life	
				Load factor $I_o \leq 75\%$	Load factor $75\% < I_o \leq 100\%$
A	Convection	AC85 - 170V	Ta = 45°C or less Ta = 55°C	10years 7years	8years 4years
		AC170 - 264V	Ta = 45°C or less Ta = 55°C	10years 10years 7years	10years 7years
B	Convection	AC85 - 170V	Ta = 35°C or less Ta = 45°C	10years 8years	10years 7years
		AC170 - 264V	Ta = 30°C or less Ta = 40°C	10years 10years	10years 10years
C	Convection	AC85 - 170V	Ta = 30°C or less Ta = 40°C	10years 10years	10years 8years
		AC170 - 264V	Ta = 30°C or less Ta = 40°C	10years 10years	10years 10years
D	Convection	AC85 - 170V	Ta = 35°C or less Ta = 45°C	10years 10years	8years 4years
		AC170 - 264V	Ta = 30°C or less Ta = 40°C	10years 10years	10years 10years
E	Convection	AC85 - 170V	Ta = 35°C or less Ta = 45°C	10years 10years	10years 5years
		AC170 - 264V	Ta = 30°C or less Ta = 40°C	10years 10years	10years 10years
A,B,C,D and E	Forced air	AC85 - 264V	Ta = 70°C	5years	3years

Table 5.9 Expectancy Life (KHEA120F, KHNA120F)

Mounting method	Cooling method	Input voltage	Average ambient temperature (year)	Expectancy Life	
				Load factor $I_o \leq 75\%$	Load factor $75\% < I_o \leq 100\%$
A	Convection	AC85 - 170V	Ta = 50°C or less Ta = 60°C	10years 8years	8years 3years
		AC170 - 264V	Ta = 50°C or less Ta = 60°C	10years 5years	6years 4years
B	Convection	AC85 - 170V	Ta = 40°C or less Ta = 50°C	10years 8years	10years 5years
		AC170 - 264V	Ta = 40°C or less Ta = 50°C	10years 10years 8years 5years	10years 10years 5years
C	Convection	AC85 - 170V	Ta = 20°C or less Ta = 30°C	10years 10years	10years 10years
		AC170 - 264V	Ta = 40°C or less Ta = 50°C	10years 5years	10years 3years
D	Convection	AC85 - 170V	Ta = 20°C or less Ta = 30°C	10years 10years	10years 8years
		AC170 - 264V	Ta = 40°C or less Ta = 50°C	10years 5years	8years 3years
E	Convection	AC85 - 170V	Ta = 20°C or less Ta = 30°C	10years 10years	10years 8years
		AC170 - 264V	Ta = 40°C or less Ta = 50°C	10years 5years	10years 3years
A,B,C,D and E	Forced air	AC85 - 264V	Ta = 70°C	5years	3years

Table 5.10 Expectancy Life (KHEA240F, KHNA240F)

Mounting method	Cooling method	Input voltage	Average ambient temperature (year)	Expectancy Life	
				Load factor $I_o \leq 75\%$	Load factor $75\% < I_o \leq 100\%$
A	Convection	AC85 - 170V	Ta = 40°C or less Ta = 50°C	10years 5years	6years 3years
		AC170 - 264V	Ta = 50°C or less Ta = 60°C	10years 5years	6years 3years
B	Convection	AC85 - 170V	Ta = 30°C or less Ta = 40°C	10years 10years	10years 8years
		AC170 - 264V	Ta = 40°C or less Ta = 50°C	10years 10years	10years 6years
C	Convection	AC85 - 170V	Ta = 20°C or less Ta = 30°C	10years 10years	10years 8years
		AC170 - 264V	Ta = 40°C or less Ta = 50°C	10years 6years	8years 3years
D and E	Convection	AC85 - 170V	Ta = 20°C or less Ta = 30°C	10years 10years	10years 5years
		AC170 - 264V	Ta = 40°C or less Ta = 50°C	10years 5years	6years 3years
A,B,C,D and E	Forced air	AC85 - 264V	Ta = 70°C	5years	3years

Table 5.11 Expectancy Life (KHEA480F, KHNA480F)

Mounting method	Cooling method	Input voltage	Average ambient temperature (year)	Expectancy Life	
				Load factor $I_o \leq 75\%$	Load factor $75\% < I_o \leq 100\%$
A	Convection	AC85 - 170V	Ta = 40°C or less Ta = 45°C Ta = 50°C	10years 7years 5years	4years 3years 2years
		AC170 - 264V	Ta = 50°C or less Ta = 55°C Ta = 60°C	8years 5years 4years	4years 3years 2years
B	Convection	AC85 - 170V	Ta = 10°C or less Ta = 20°C	10years 10years	10years 10years
		AC170 - 264V	Ta = 20°C or less Ta = 30°C	10years 10years	10years 10years
C	Convection	AC85 - 170V	Ta = 15°C or less Ta = 25°C	10years 10years	10years 5years
		AC170 - 264V	Ta = 30°C or less Ta = 40°C	10years 8years	7years 3years
D	Convection	AC85 - 170V	Ta = 10°C or less Ta = 20°C	10years 10years	10years 5years
		AC170 - 264V	Ta = 20°C or less Ta = 30°C	10years 10years	10years 5years
E	Convection	AC85 - 170V	Ta = 10°C or less Ta = 20°C	10years 8years	7years 3years
		AC170 - 264V	Ta = 20°C or less Ta = 30°C	10years 10years	7years 3years
A,B,C,D and E	Forced air	AC85 - 264V	Ta = 70°C	5years	3years

■Warranty

Table 5.12 Warranty (KHEA30F, KHNA30F)

Mounting method	Cooling method	Input voltage	Average ambient temperature (year)	Warranty term	
				Load factor $l_o \leq 75\%$	Load factor $75\% < l_o \leq 100\%$
A	Convection	AC85 - 170V	Ta = 50°C or less Ta = 60°C	5years 5years	5years 3years
		AC170 - 264V	Ta = 50°C or less Ta = 60°C	5years 5years	5years 3years
B	Convection	AC85 - 170V	Ta = 40°C or less Ta = 50°C	5years 5years	5years 3years
		AC170 - 264V	Ta = 50°C or less Ta = 60°C	5years 5years	5years 3years
C	Convection	AC85 - 170V	Ta = 35°C or less Ta = 45°C	5years 5years	5years 5years
		AC170 - 264V	Ta = 50°C or less Ta = 60°C	5years 5years	5years 3years
D and E	Convection	AC85 - 170V	Ta = 35°C or less Ta = 45°C	5years 5years	5years 3years
		AC170 - 264V	Ta = 50°C or less Ta = 60°C	5years 5years	5years 3years
A,B,C,D and E	Forced air	AC85 - 264V	Ta = 70°C	5years	3years

Table 5.13 Warranty (KHEA60F, KHNA60F)

Mounting method	Cooling method	Input voltage	Average ambient temperature (year)	Warranty term	
				Load factor $l_o \leq 75\%$	Load factor $75\% < l_o \leq 100\%$
A	Convection	AC85 - 170V	Ta = 45°C or less Ta = 55°C	5years 5years	3years 3years
		AC170 - 264V	Ta = 45°C or less Ta = 55°C	5years 5years	5years 3years
B	Convection	AC85 - 170V	Ta = 30°C or less Ta = 40°C	5years 5years	5years 3years
		AC170 - 264V	Ta = 45°C or less Ta = 55°C	5years 5years	3years 3years
C	Convection	AC85 - 170V	Ta = 40°C or less Ta = 50°C	5years 5years	3years 3years
		AC170 - 264V	Ta = 40°C or less Ta = 50°C	5years 5years	5years 3years
D	Convection	AC85 - 170V	Ta = 30°C or less Ta = 40°C	5years 5years	3years 2years
		AC170 - 264V	Ta = 40°C or less Ta = 50°C	5years 5years	5years 3years
E	Convection	AC85 - 170V	Ta = 30°C or less Ta = 40°C	5years 5years	3years 3years
		AC170 - 264V	Ta = 35°C or less Ta = 45°C	5years 5years	5years 3years
A,B,C,D and E	Forced air	AC85 - 264V	Ta = 70°C	5years	3years

Table 5.14 Warranty (KHEA90F, KHNA90F)

Mounting method	Cooling method	Input voltage	Average ambient temperature (year)	Warranty term	
				Load factor $l_o \leq 75\%$	Load factor $75\% < l_o \leq 100\%$
A	Convection	AC85 - 170V	Ta = 45°C or less Ta = 55°C	5years 5years	5years 3years
		AC170 - 264V	Ta = 45°C or less Ta = 55°C	5years 5years	5years 5years
B	Convection	AC85 - 170V	Ta = 35°C or less Ta = 45°C	5years 5years	5years 5years
		AC170 - 264V	Ta = 30°C or less Ta = 40°C	5years 5years	5years 5years
C	Convection	AC85 - 170V	Ta = 30°C or less Ta = 40°C	5years 5years	5years 5years
		AC170 - 264V	Ta = 30°C or less Ta = 40°C	5years 5years	5years 5years
D and E	Convection	AC85 - 170V	Ta = 35°C or less Ta = 45°C	5years 5years	5years 3years
		AC170 - 264V	Ta = 30°C or less Ta = 40°C	5years 5years	5years 5years
A,B,C,D and E	Forced air	AC85 - 264V	Ta = 70°C	5years	3years

Table 5.15 Warranty (KHEA120F, KHNA120F)

Mounting method	Cooling method	Input voltage	Average ambient temperature (year)	Warranty term	
				Load factor $l_o \leq 75\%$	Load factor $75\% < l_o \leq 100\%$
A	Convection	AC85 - 170V	Ta = 50°C or less Ta = 60°C	5years 5years	5years 3years
		AC170 - 264V	Ta = 50°C or less Ta = 60°C	5years 5years	5years 4years
B	Convection	AC85 - 170V	Ta = 40°C or less Ta = 50°C	5years 5years	5years 5years
		AC170 - 264V	Ta = 40°C or less Ta = 50°C	5years 5years	5years 5years
C,D and E	Convection	AC85 - 170V	Ta = 20°C or less Ta = 30°C	5years 5years	5years 5years
		AC170 - 264V	Ta = 40°C or less Ta = 50°C	5years 5years	5years 3years
A,B,C,D and E	Forced air	AC85 - 264V	Ta = 70°C	5years	3years

Table 5.16 Warranty (KHEA240F, KHNA240F)

Mounting method	Cooling method	Input voltage	Average ambient temperature (year)	Warranty term	
				Load factor $l_o \leq 75\%$	Load factor $75\% < l_o \leq 100\%$
A	Convection	AC85 - 170V	Ta = 40°C or less Ta = 50°C	5years 5years	5years 3years
		AC170 - 264V	Ta = 50°C or less Ta = 60°C	5years 5years	5years 3years
B	Convection	AC85 - 170V	Ta = 30°C or less Ta = 40°C	5years 5years	5years 5years
		AC170 - 264V	Ta = 40°C or less Ta = 50°C	5years 5years	5years 5years
C,D and E	Convection	AC85 - 170V	Ta = 20°C or less Ta = 30°C	5years 5years	5years 5years
		AC170 - 264V	Ta = 40°C or less Ta = 50°C	5years 5years	5years 3years
A,B,C,D and E	Forced air	AC85 - 264V	Ta = 70°C	5years	3years

Table 5.17 Warranty (KHEA480F, KHNA480F)

Mounting method	Cooling method	Input voltage	Average ambient temperature (year)	Warranty term	
				Load factor $Io \leq 75\%$	Load factor $75\% < Io \leq 100\%$
A	Convection	AC85 - 170V	Ta = 40°C or less	5years	4years
			Ta = 45°C	5years	3years
			Ta = 50°C	4years	2years
		AC170 - 264V	Ta = 50°C or less	5years	4years
			Ta = 55°C	5years	3years
			Ta = 60°C	4years	2years
B	Convection	AC85 - 170V	Ta = 10°C or less	5years	5years
			Ta = 20°C	5years	5years
		AC170 - 264V	Ta = 20°C or less	5years	5years
			Ta = 30°C	5years	5years
			Ta = 30°C	5years	5years
			Ta = 30°C	5years	5years
C	Convection	AC85 - 170V	Ta = 15°C or less	5years	5years
			Ta = 25°C	5years	5years
		AC170 - 264V	Ta = 30°C or less	5years	5years
			Ta = 40°C	5years	3years
			Ta = 10°C or less	5years	5years
			Ta = 20°C	5years	5years
D	Convection	AC85 - 170V	Ta = 10°C or less	5years	5years
			Ta = 20°C	5years	5years
		AC170 - 264V	Ta = 20°C or less	5years	5years
			Ta = 30°C	5years	5years
			Ta = 30°C	5years	5years
			Ta = 30°C	5years	5years
E	Convection	AC85 - 170V	Ta = 10°C or less	5years	5years
			Ta = 20°C	5years	3years
		AC170 - 264V	Ta = 20°C or less	5years	5years
			Ta = 30°C	5years	3years
			Ta = 30°C	5years	3years
			Ta = 30°C	5years	3years
A,B,C,D and E	Forced air	AC85 - 264V	Ta = 70°C	5years	3years

5.6 Applicable Electric Cable

■ Input terminals, Output terminals

● **KHEA30F/60F/90F/120F/240F**

Table 5.18 Applicable Wire

	Input terminals	Output terminals
Solid wire	Diameter 0.5 mm to 2.6 mm (AWG.24 to AWG.10)	
Stranded wire	0.2mm ² to 5.2mm ² (AWG.24 to AWG.10)	
	Conductor diameter more than 0.18mm	
Sheath strip length	8mm	

● **KHEA480F**

Table 5.19 Applicable Wire

	Input terminals	Output terminals
Solid wire	Diameter 0.8 mm to 2.6 mm (AWG.20 to AWG.10)	
Stranded wire	0.5mm ² to 5.2mm ² (AWG.20 to AWG.10)	
	Conductor diameter more than 0.18mm	
Sheath strip length	8mm	

■ RC terminals

● **KHEA120F/240F/480F, KHNA120F/240F/480F**

Table 5.20 Applicable Wire

	RC terminals
Solid wire	Diameter 0.5 mm to 1.3 mm (AWG.24 to AWG.16)
Stranded wire	0.2 mm ² to 1.5 mm ² (AWG.24 to AWG.16)
	Conductor diameter more than 0.18mm
Sheath strip length	8mm

5.7 Applicable Electric Cable

■ While turning on the electricity, and for a while after turning off, please don't touch the inside of a power supply because there are some hot parts in that.

■ When a mass capacitor is connected with the output terminal (load side), the output might become the stop or an unstable operation. Please contact us for details when you connect the capacitor.

6 Option

6.1 Outline of option

● **-C**

· Option -C units have coated internal PCB for better moisture resistance.

● **-E**

(KHEA90F, KHNA90F)

· Option -E units acquires NEC Class2.

● **-N2**

(KHEA120F/240F/480F, KHNA120F/240F/480F)

· Option -N2 units have attachment with screw mounting instead of DIN rail mounting.

Mounting holes pitch are shown in Table 6.1.

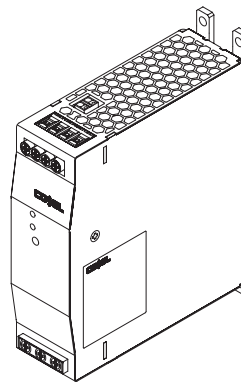

Fig.6.1 Image of option -N2

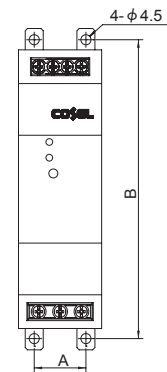

Fig.6.2 Mounting place (screw holes)

Table 6.1 Mounting holes pitch

No.	Model	A	B
1	KHEA120F, KHNA120F	23mm	133mm
2	KHEA240F, KHNA240F	34mm	133mm
3	KHEA480F, KHNA480F	54mm	133mm