

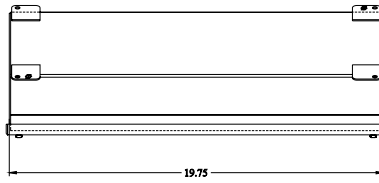

PART No. 1490MG16
 for more information visit
www.hammfg.com
 Data subject to change without notice
 Isometric drawing Not to Scale

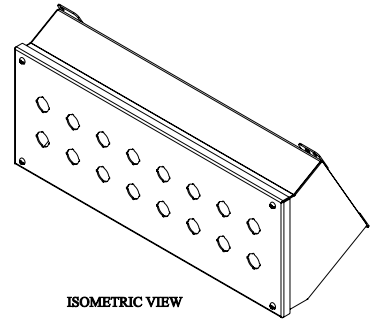

TOP VIEW



ISOMETRIC VIEW

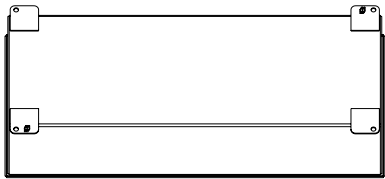

BACK VIEW

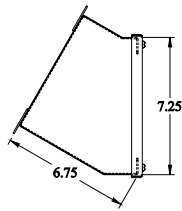

LEFT SIDE VIEW

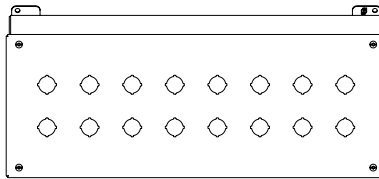

FRONT VIEW

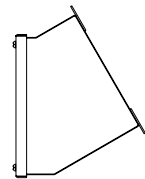

RIGHT SIDE VIEW

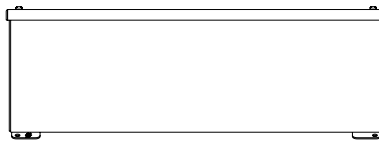

BOTTOM VIEW