

- NOTES:
1. ASSURE ASSEMBLY CAPABILITY BY MATCHING WITH MATING PART
 2. DIMENSIONS IN BRACKETS ARE IN MILLIMETERS

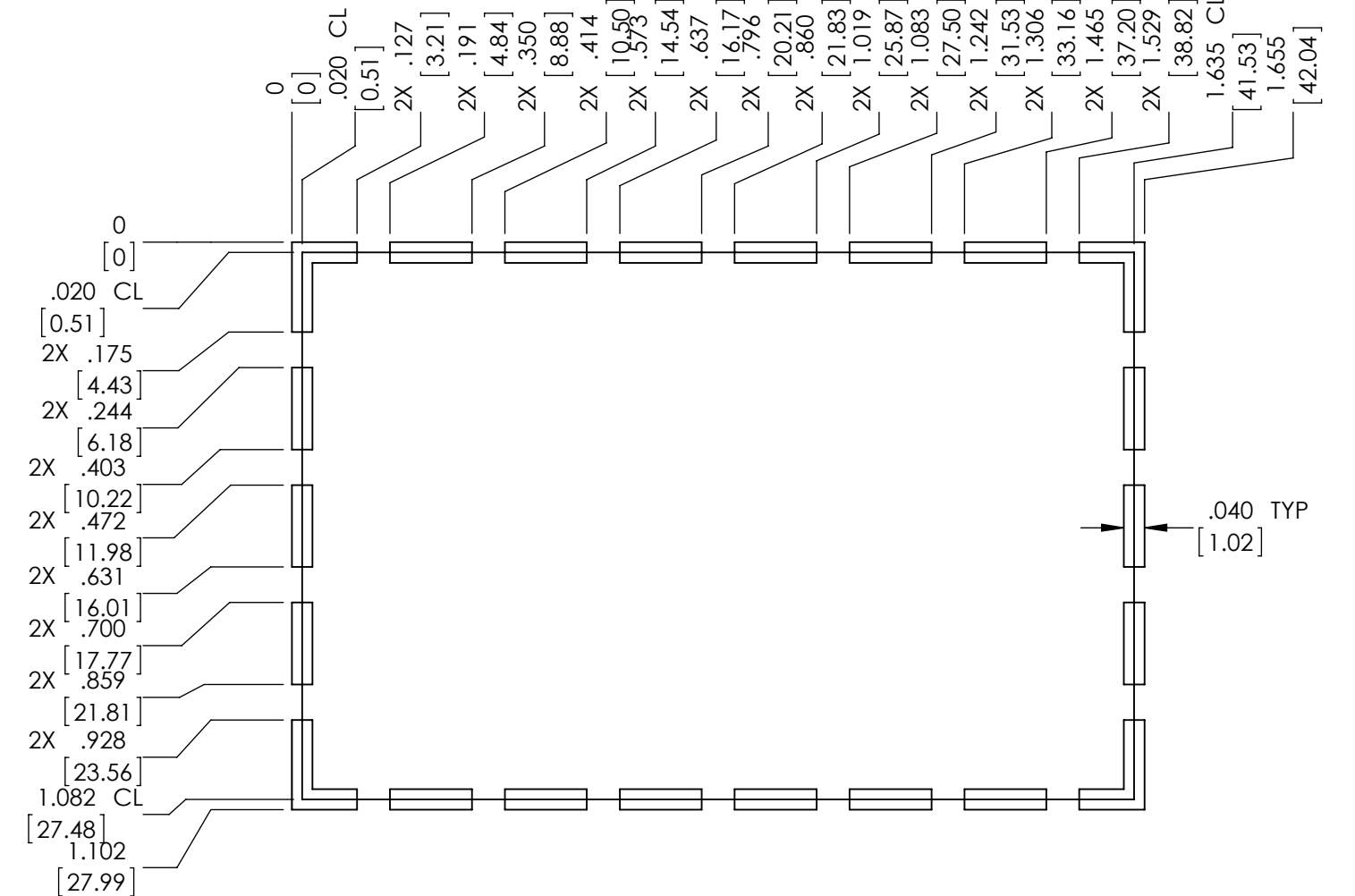

TRACE PATTERN

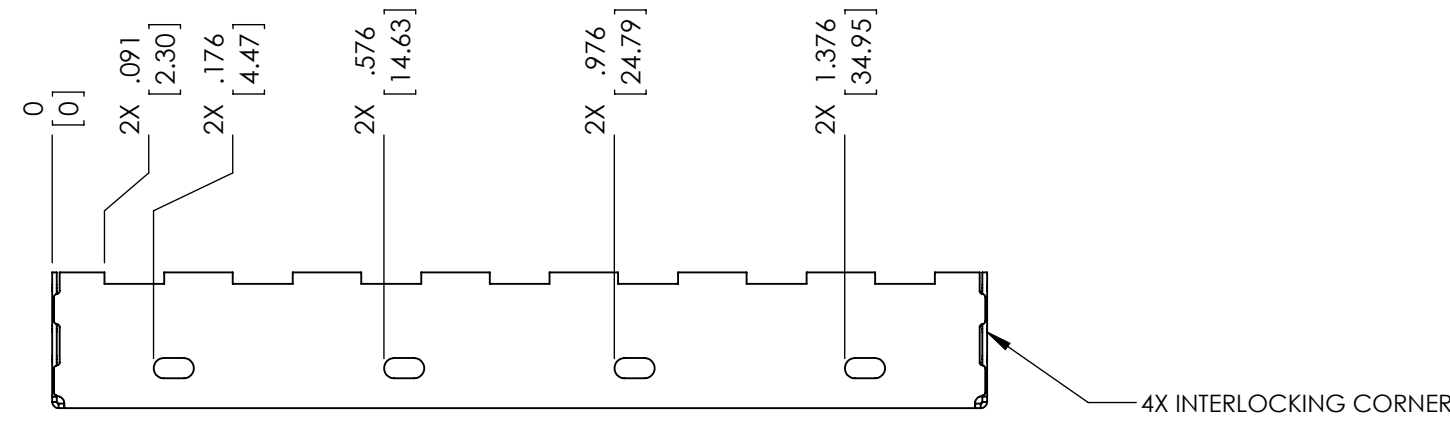
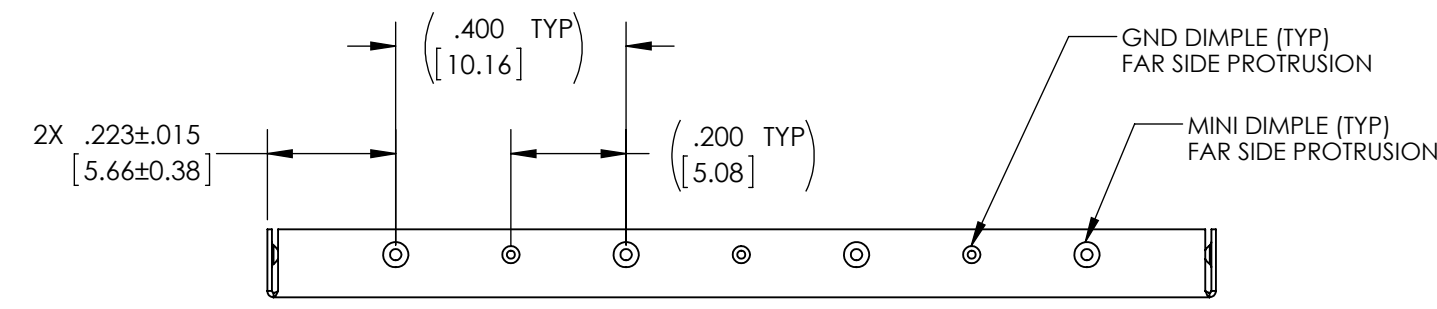
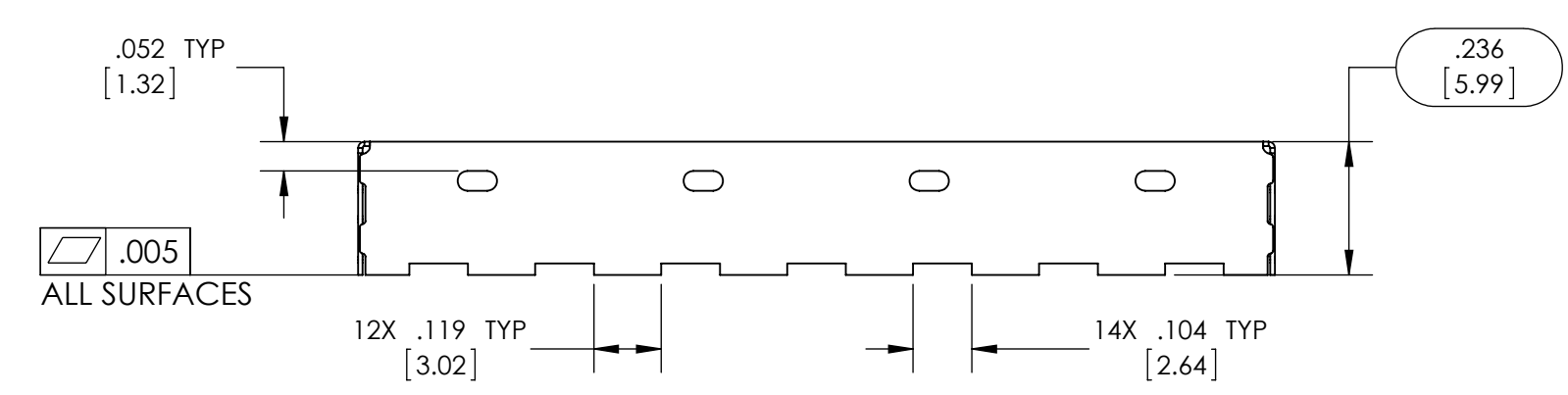
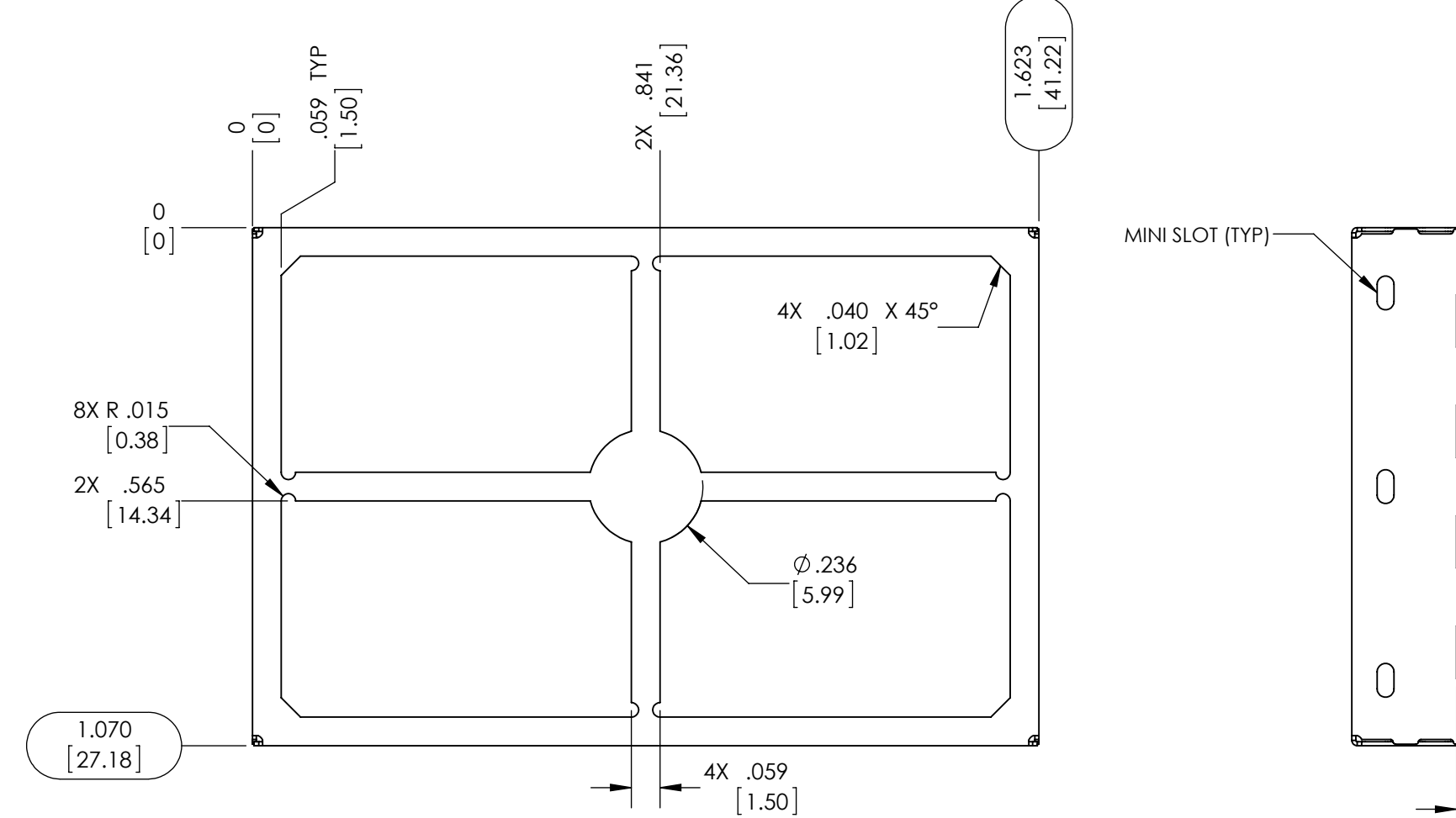
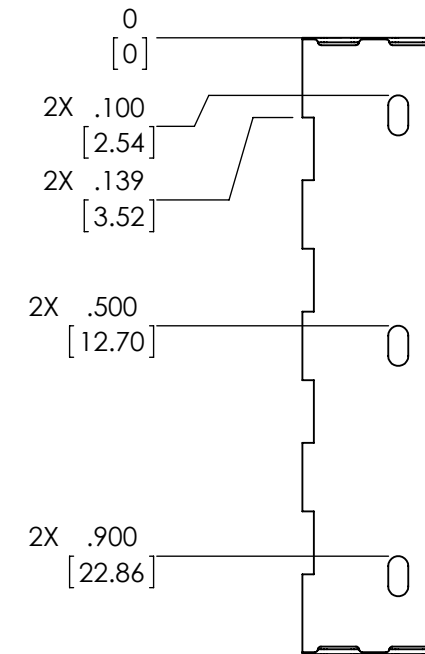
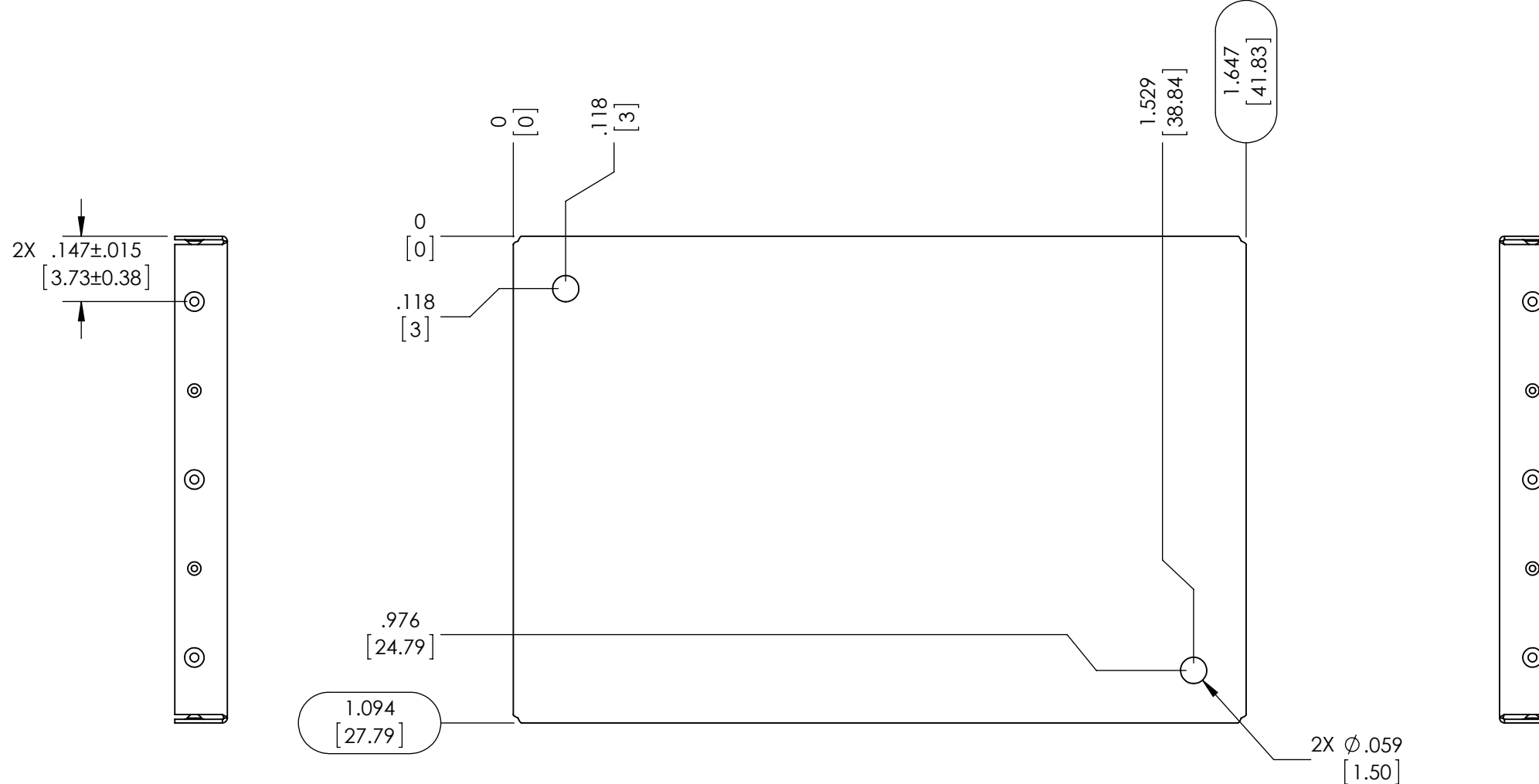

FORMED FRAME

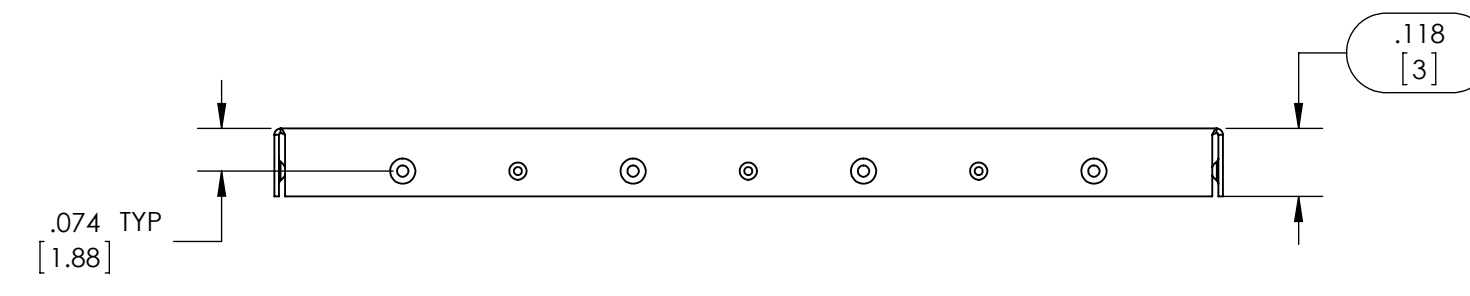
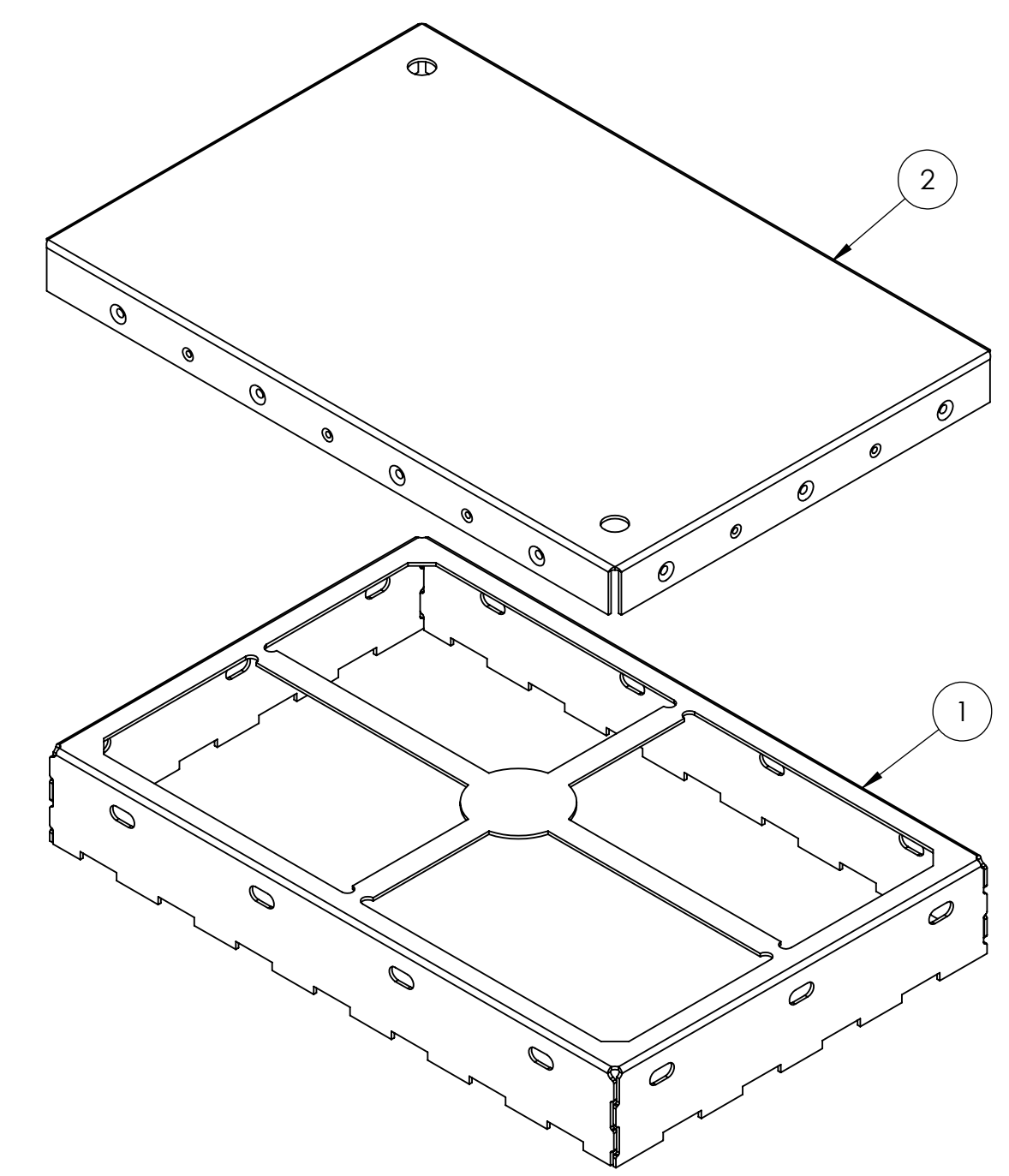

FORMED COVER

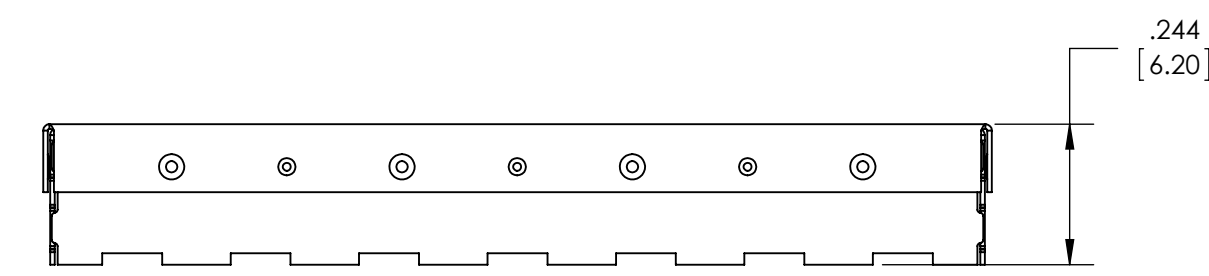

ASSEMBLY

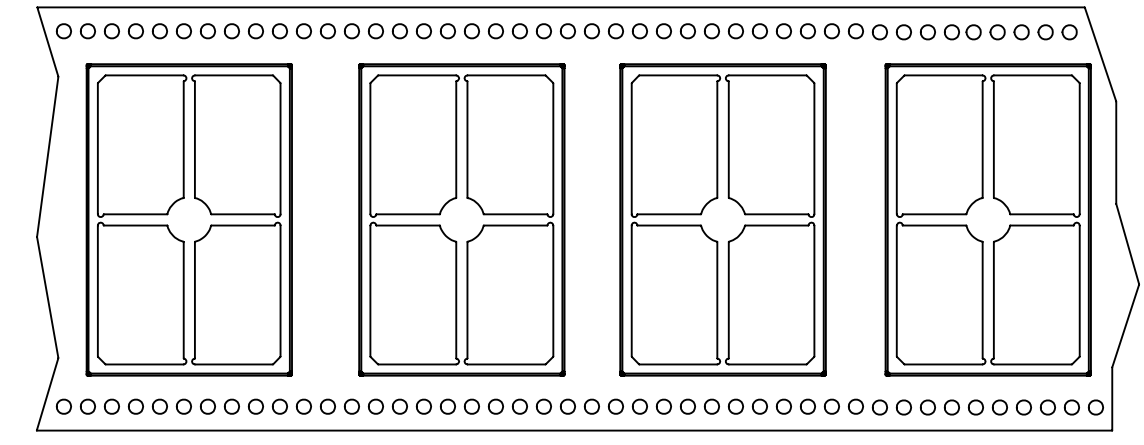

CARRIER TAPE

CARRIER TAPE SPECIFICATIONS						
PART NUMBER	DESCRIPTION	OVERALL DIMENSIONS	OVERALL HEIGHT	CARRIER TAPE WIDTH	CARRIER TAPE PITCH	PARTS PER REEL
SMS-459F	FRAME	1.070 X 1.623 [27.18 X 41.22]	.236 [5.99]	56 mm	36 mm	230
SMS-459C	COVER	1.094 X 1.647 [27.79 X 41.83]	.118 [3.00]	N/A	N/A	BULK PACK

THIS DOCUMENT CONTAINS PROPRIETARY INFORMATION OWNED BY LEADTECH OR DEVELOPED AT ITS OWN PRIVATE EXPENSE AND MAY NOT BE USED, DUPLICATED OR DISCLOSED IN WHOLE OR IN PART FOR ANY PURPOSE INCLUDING DESIGN, MANUFACTURE OR PROCUREMENT WITHOUT THE WRITTEN PERMISSION OF LEADTECH. LEADTECH DOES NOT GUARANTEE OR WARRANT THE PERFORMANCE CHARACTERISTICS.

ITEM NO.	PART NUMBER	DESCRIPTION	QTY.
1	SMS-459F	FRAME	1
2	SMS-459C	COVER	1

UNLESS OTHERWISE SPECIFIED:
 - ALL DIMENSIONS ARE IN INCHES
 - PART SHALL BE FREE OF BURRS AND SHARP EDGES
 - ALL DIMENSIONS SHOWN APPLY AFTER PLATING AND COATINGS
 - ROHS COMPLIANT PER EU DIRECTIVE 2011/65/EU
 - POI = POINT OF INTERSECTION

THIRD ANGLE PROJECTION
 ANGLES +/- 2°

DRAWN BY: SDH
 APPROVED BY: ND

DATE: 2015-11-02
 DATE: 2015-11-09

FRSHE: MATTE
 MATERIAL: .008" PRE TIN STEEL

SCALE: 3:1
 DWG. NO.: D
 SHEET: 1 OF 1

REV: A

TITLE: SURFACE MOUNT SHIELD

LEADER TECH
 a HEICO company
 The Leading Edge in PAM Manufacturing Technology