

NTBS2D7N06M7

N-Channel PowerTrench[®] MOSFET

60 V, 110 A, 2.7 mΩ

Features

- Typical $R_{DS(on)} = 2.2\text{ m}\Omega$ at $V_{GS} = 10\text{ V}$, $I_D = 80\text{ A}$
- Typical $Q_{g(tot)} = 80\text{ nC}$ at $V_{GS} = 10\text{ V}$, $I_D = 80\text{ A}$
- UIS Capability
- These Devices are Pb-Free and are RoHS Compliant

Applications

- Industrial Motor Drive
- Industrial Power Supply
- Industrial Automation
- Battery Operated Tools
- Battery Protection
- Solar Inverters
- UPS and Energy Inverters
- Energy Storage
- Load Switch

ABSOLUTE MAXIMUM RATINGS ($T_J = 25^\circ\text{C}$, Unless otherwise noted)

Rating	Symbol	Value	Unit
Drain-to-Source Voltage	V_{DSS}	60	V
Gate-to-Source Voltage	V_{GS}	± 20	V
Drain Current – Continuous ($T_C = 25^\circ\text{C}$) ($V_{GS} = 10$) (Note 1)	I_D	110	A
Pulsed Drain Current ($T_C = 25^\circ\text{C}$)		See Figure 4	
Single Pulse Avalanche Energy (Note 2)	E_{AS}	193	mJ
Power Dissipation	P_D	176	W
Derate Above 25°C		1.2	W/ $^\circ\text{C}$
Operating and Storage Temperature Range	T_J, T_{STG}	-55 to $+175$	$^\circ\text{C}$
Thermal Resistance, Junction to Case	$R_{\theta JC}$	0.85	$^\circ\text{C/W}$
Maximum Thermal Resistance, Junction to Ambient (Note 3)	$R_{\theta JA}$	43	$^\circ\text{C/W}$

Stresses exceeding those listed in the Maximum Ratings table may damage the device. If any of these limits are exceeded, device functionality should not be assumed, damage may occur and reliability may be affected.

1. Current is limited by bondwire configuration.
2. Starting $T_J = 25^\circ\text{C}$, $L = 50\text{ }\mu\text{H}$, $I_{AS} = 88\text{ A}$, $V_{DD} = 60\text{ V}$ during inductor charging and $V_{DD} = 0\text{ V}$ during time in avalanche.
3. $R_{\theta JA}$ is the sum of the junction-to-case and case-to-ambient thermal resistance, where the case thermal reference is defined as the solder mounting surface of the drain pins. $R_{\theta JC}$ is guaranteed by design, while $R_{\theta JA}$ is determined by the board design. The maximum rating presented here is based on mounting on a 1 in² pad of 2oz copper.



ON Semiconductor[®]

www.onsemi.com

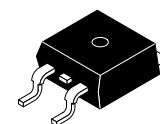
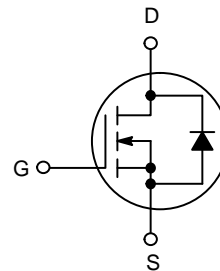

D²PAK-3
TO-263
CASE 418AJ

MARKING DIAGRAM



NTBS2D7N06M7 = Specific Device Code
A = Assembly Location
Y = Year
WW = Work Week
G = Pb-Free Package

ORDERING INFORMATION

See detailed ordering and shipping information on page 2 of this data sheet.

NTBS2D7N06M7

PACKAGE MARKING AND ORDERING INFORMATION

Device	Device Marking	Package	Reel Size	Tape Width	Quantity
NTBS2D7N06M7	NTBS2D7N	D ² PAK (TO-263)	330 mm	24 mm	800 Units

†For information on tape and reel specifications, including part orientation and tape sizes, please refer to our Tape and Reel Packaging Specifications Brochure, [BRD8011/D](#).

ELECTRICAL CHARACTERISTICS (T_J = 25°C unless otherwise noted)

Symbol	Parameter	Test Conditions	Min	Typ	Max	Unit
--------	-----------	-----------------	-----	-----	-----	------

OFF CHARACTERISTICS

BV _{DSS}	Drain-to-Source Breakdown Voltage	V _{GS} = 0 V, I _D = 250 μA	60	–	–	V
I _{DSS}	Drain-to-Source Leakage Current	V _{DS} = 60 V, V _{GS} = 0 V, T _J = 25°C	–	–	1	μA
		V _{DS} = 60 V, V _{GS} = 0 V, T _J = 175°C (Note 4)	–	–	1	mA
I _{GSS}	Gate-to-Source Leakage Current	V _{GS} = ±20 V	–	–	±100	nA

ON CHARACTERISTICS

V _{GS(th)}	Gate-to-Source Threshold Voltage	V _{GS} = V _{DS} , I _D = 250 μA	2.0	3.2	4.0	V
R _{DS(on)}	Drain-to-Source On Resistance	V _{GS} = 10 V, I _D = 80 A, T _J = 25°C	–	2.2	2.7	mΩ
		V _{GS} = 10 V, I _D = 80 A, T _J = 175°C (Note 4)	–	4.1	5.0	mΩ

DYNAMIC CHARACTERISTICS

C _{iss}	Input Capacitance	V _{DS} = 30 V, V _{GS} = 0 V, f = 1 MHz	–	6655	–	pF
C _{oss}	Output Capacitance		–	1745	–	pF
C _{rss}	Reverse Transfer Capacitance		–	57	–	pF
R _g	Gate Resistance	f = 1 MHz	–	2.2	–	Ω
Q _{g(tot)}	Total Gate Charge at 10 V	V _{DD} = 30 V, I _D = 80 A, V _{GS} = 0 to 10 V	–	80	110	nC
Q _{g(th)}	Threshold Gate Charge	V _{DD} = 30 V, I _D = 80 A, V _{GS} = 0 to 2 V	–	12	–	nC
Q _{gs}	Gate-to-Source Gate Charge	V _{DD} = 30 V, I _D = 80 A	–	35	–	nC
Q _{gd}	Gate-to-Drain "Miller" Charge	V _{DD} = 30 V, I _D = 80 A	–	10	–	nC

SWITCHING CHARACTERISTICS

t _(on)	Turn-On Time	V _{DD} = 30 V, I _D = 80 A, V _{GS} = 10 V, R _{GEN} = 6 Ω	–	–	115	ns
t _{d(on)}	Turn-On Delay		–	36	–	ns
t _r	Rise Time		–	52	–	ns
t _{d(off)}	Turn-Off Delay		–	36	–	ns
t _f	Fall Time		–	13	–	ns
t _{off}	Turn-Off Time		–	–	64	ns

DRAIN-SOURCE DIODE CHARACTERISTICS

V _{SD}	Source-to-Drain Diode Voltage	V _{GS} = 0 V, I _{SD} = 80 A	–	–	1.25	V
		V _{GS} = 0 V, I _{SD} = 40 A	–	–	1.2	V
t _{rr}	Reverse-Recovery Time	V _{DD} = 48 V, I _F = 80 A, dI _{SD} /dt = 100 A/μs	–	78	102	ns
Q _{rr}	Reverse-Recovery Charge		–	100	130	nC

Product parametric performance is indicated in the Electrical Characteristics for the listed test conditions, unless otherwise noted. Product performance may not be indicated by the Electrical Characteristics if operated under different conditions.

4. The maximum value is specified by design at T_J = 175°C. Product is not tested to this condition in production.

NTBS2D7N06M7

TYPICAL PERFORMANCE CHARACTERISTICS

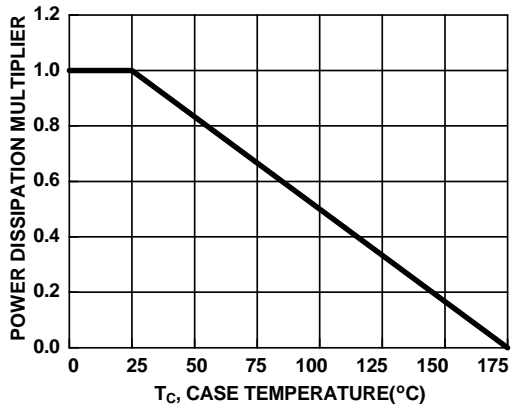

Figure 1. Normalized Power Dissipation vs. Case Temperature

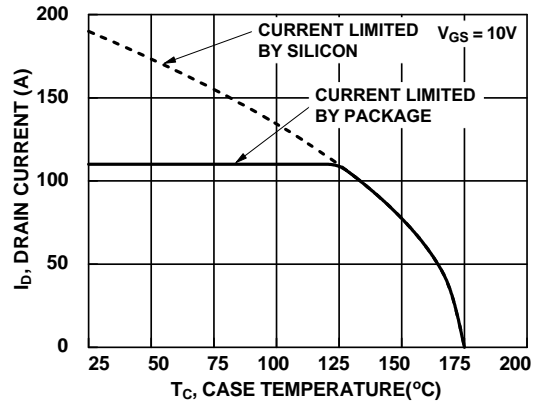

Figure 2. Maximum Continuous Drain Current vs. Case Temperature

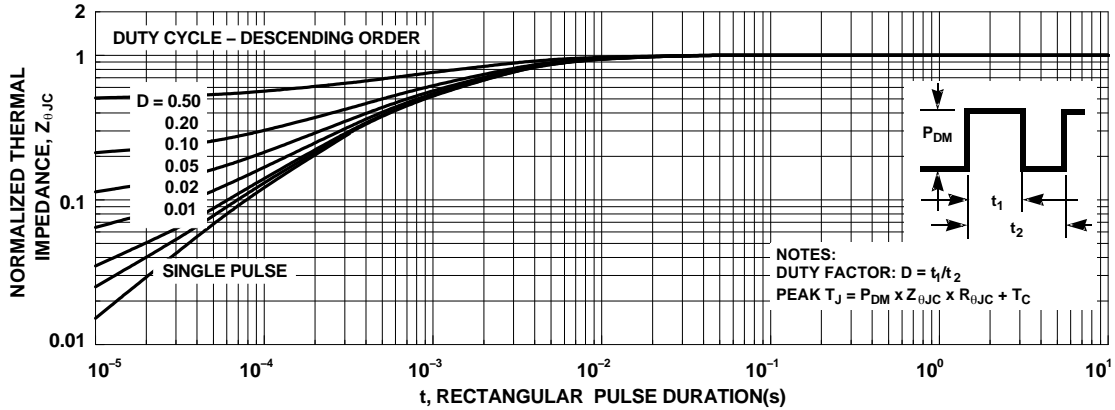

Figure 3. Normalized Maximum Transient Thermal Impedance

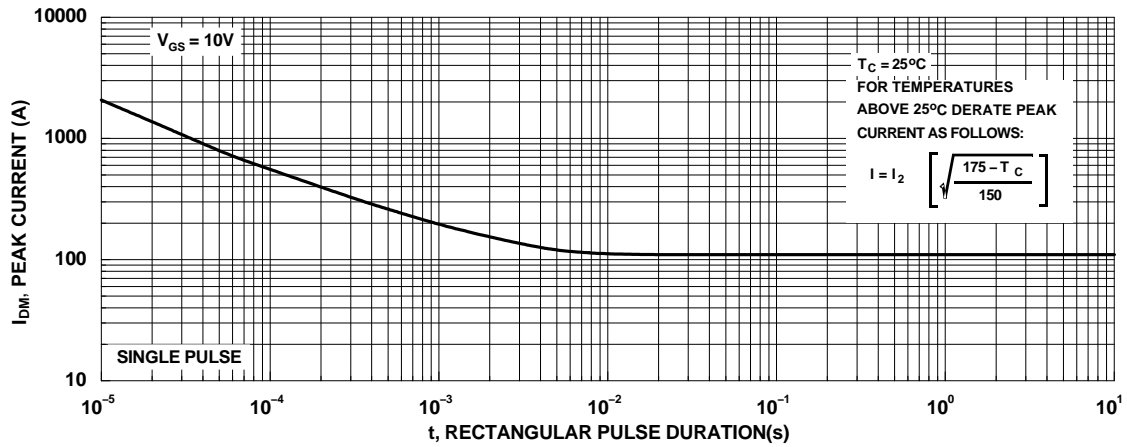

Figure 4. Peak Current Capability

TYPICAL PERFORMANCE CHARACTERISTICS

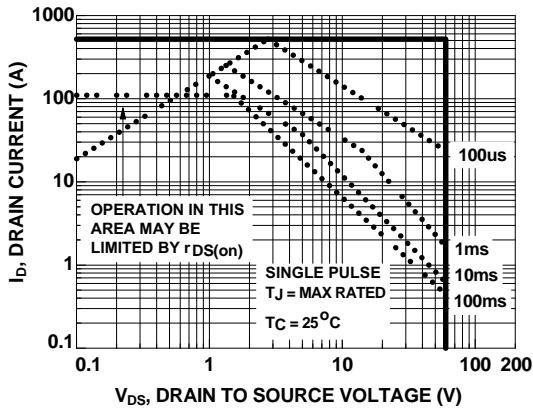
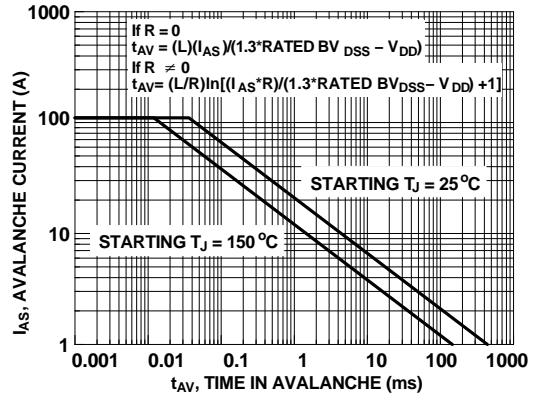

Figure 5. Forward Bias Safe Operating Area



NOTE: Refer to ON Semiconductor Application Notes AN7514 and AN7515
 Figure 6. Unclamped Inductive Switching Capability

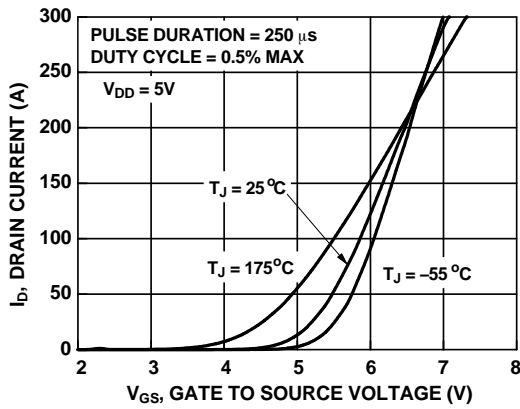

Figure 7. Transfer Characteristics

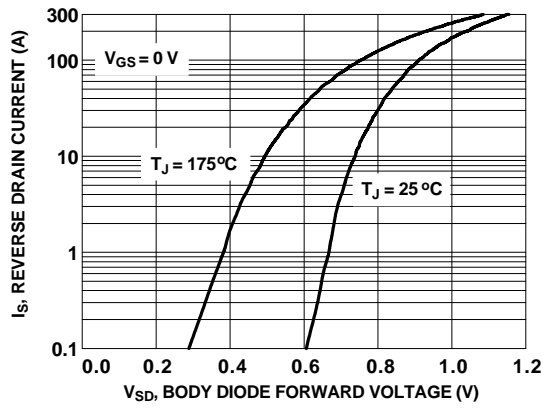

Figure 8. Forward Diode Characteristics

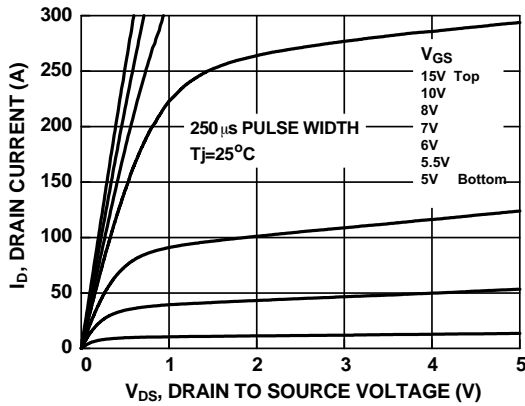

Figure 9. Saturation Characteristics

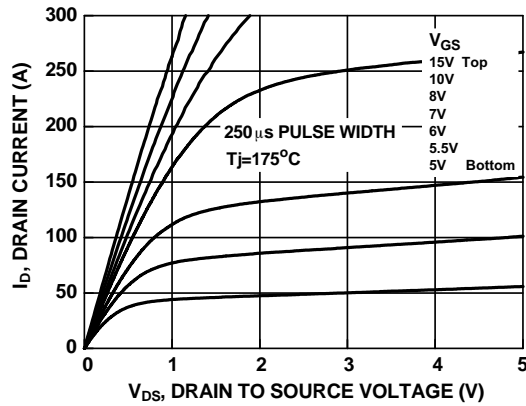

Figure 10. Saturation Characteristics

TYPICAL PERFORMANCE CHARACTERISTICS

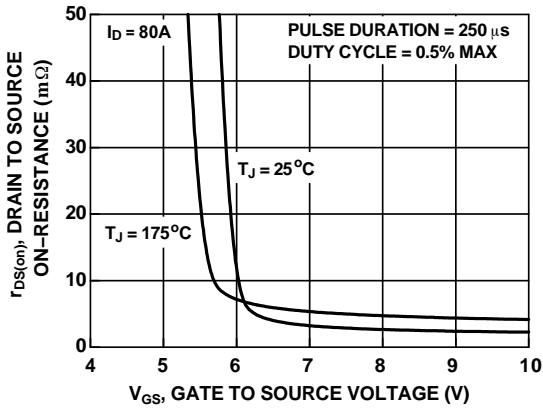

Figure 11. $R_{DS(on)}$ vs. Gate Voltage

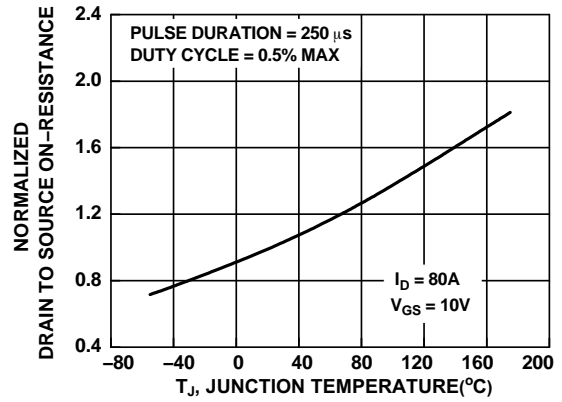

Figure 12. Normalized $R_{DS(on)}$ vs. Junction Temperature

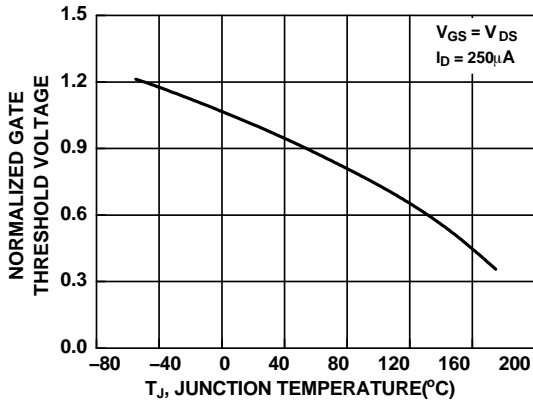

Figure 13. Normalized Gate Threshold Voltage vs. Temperature

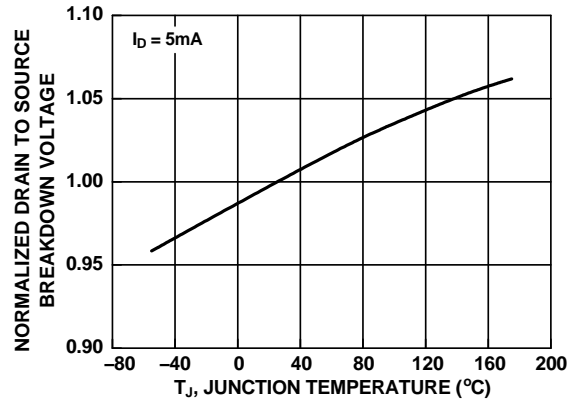

Figure 14. Normalized Drain-to-Source Breakdown Voltage vs. Junction Temperature

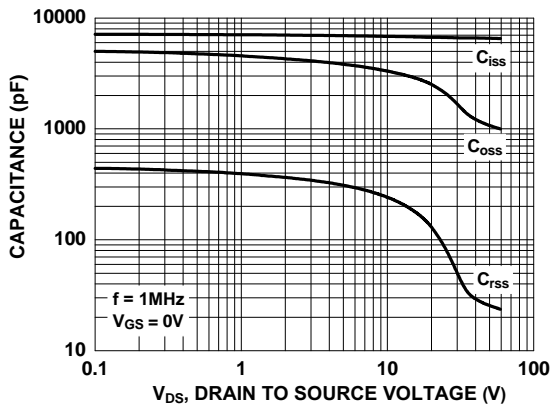

Figure 15. Capacitance vs. Drain-to-Source Voltage

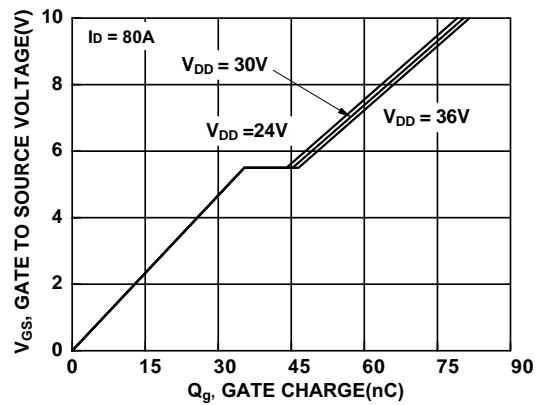
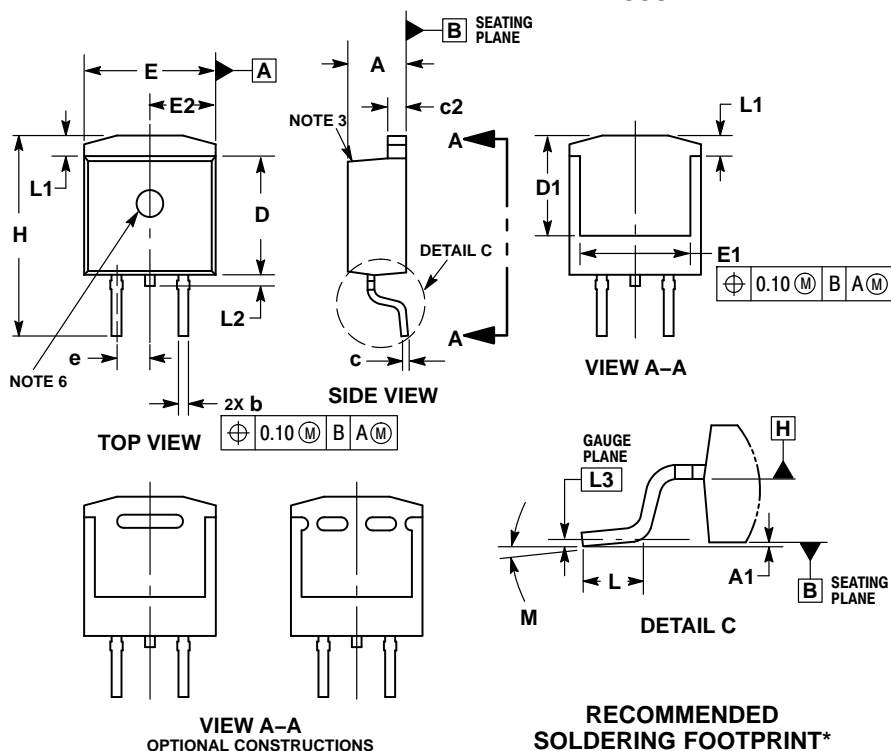

Figure 16. Gate Charge vs. Gate-to-Source Voltage

NTBS2D7N06M7

PACKAGE DIMENSIONS

D²PAK-3 (TO-263, 3-LEAD) CASE 418AJ ISSUE B



- NOTES:
1. DIMENSIONING AND TOLERANCING PER ASME Y14.5M, 1994.
 2. CONTROLLING DIMENSION: INCHES.
 3. CHAMFER OPTIONAL
 4. DIMENSIONS D AND E DO NOT INCLUDE MOLD FLASH. MOLD FLASH SHALL NOT EXCEED 0.005 PER SIDE. THESE DIMENSIONS ARE MEASURED AT THE OUTERMOST EXTREMES OF THE PLASTIC BODY AT DATUM H.
 5. THERMAL PAD CONTOUR IS OPTIONAL WITHIN DIMENSIONS E, L1, D1 AND E1.
 6. OPTIONAL MOLD FEATURE

DIM	INCHES		MILLIMETERS	
	MIN	MAX	MIN	MAX
A	0.160	0.190	4.06	4.83
A1	0.000	0.010	0.00	0.25
b	0.020	0.039	0.51	0.99
c	0.012	0.029	0.30	0.74
c2	0.045	0.065	1.14	1.65
D	0.330	0.380	8.38	9.65
D1	0.260	---	6.60	---
E	0.380	0.420	9.65	10.67
E1	0.245	---	6.22	---
e	0.100 BSC		2.54 BSC	
H	0.575	0.625	14.60	15.88
L	0.070	0.110	1.78	2.79
L1	---	0.066	---	1.68
L2	---	0.070	---	1.78
L3	0.010 BSC		0.25 BSC	
M	0°	8°	0°	8°

RECOMMENDED SOLDERING FOOTPRINT*

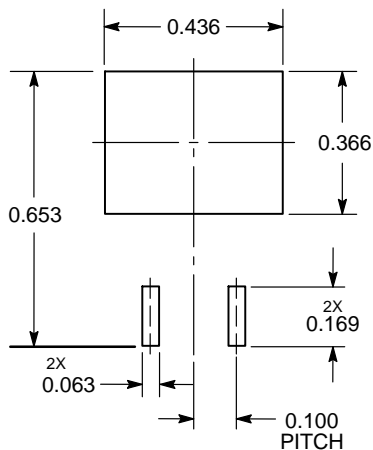

DIMENSIONS: INCHES

*For additional information on our Pb-Free strategy and soldering details, please download the ON Semiconductor Soldering and Mounting Techniques Reference Manual, SOLDERRM/D.

POWERTRENCH is a registered trademark of Semiconductor Components Industries, LLC.

ON Semiconductor and  are trademarks of Semiconductor Components Industries, LLC dba ON Semiconductor or its subsidiaries in the United States and/or other countries. ON Semiconductor owns the rights to a number of patents, trademarks, copyrights, trade secrets, and other intellectual property. A listing of ON Semiconductor's product/patent coverage may be accessed at www.onsemi.com/site/pdf/Patent-Marking.pdf. ON Semiconductor reserves the right to make changes without further notice to any products herein. ON Semiconductor makes no warranty, representation or guarantee regarding the suitability of its products for any particular purpose, nor does ON Semiconductor assume any liability arising out of the application or use of any product or circuit, and specifically disclaims any and all liability, including without limitation special, consequential or incidental damages. Buyer is responsible for its products and applications using ON Semiconductor products, including compliance with all laws, regulations and safety requirements or standards, regardless of any support or applications information provided by ON Semiconductor. "Typical" parameters which may be provided in ON Semiconductor data sheets and/or specifications can and do vary in different applications and actual performance may vary over time. All operating parameters, including "Typicals" must be validated for each customer application by customer's technical experts. ON Semiconductor does not convey any license under its patent rights nor the rights of others. ON Semiconductor products are not designed, intended, or authorized for use as a critical component in life support systems or any FDA Class 3 medical devices or medical devices with a same or similar classification in a foreign jurisdiction or any devices intended for implantation in the human body. Should Buyer purchase or use ON Semiconductor products for any such unintended or unauthorized application, Buyer shall indemnify and hold ON Semiconductor and its officers, employees, subsidiaries, affiliates, and distributors harmless against all claims, costs, damages, and expenses, and reasonable attorney fees arising out of, directly or indirectly, any claim of personal injury or death associated with such unintended or unauthorized use, even if such claim alleges that ON Semiconductor was negligent regarding the design or manufacture of the part. ON Semiconductor is an Equal Opportunity/Affirmative Action Employer. This literature is subject to all applicable copyright laws and is not for resale in any manner.

PUBLICATION ORDERING INFORMATION

LITERATURE FULFILLMENT:

Literature Distribution Center for ON Semiconductor
19521 E. 32nd Pkwy, Aurora, Colorado 80011 USA
Phone: 303-675-2175 or 800-344-3860 Toll Free USA/Canada
Fax: 303-675-2176 or 800-344-3867 Toll Free USA/Canada
Email: orderlit@onsemi.com

N. American Technical Support: 800-282-9855 Toll Free
USA/Canada
Europe, Middle East and Africa Technical Support:
Phone: 421 33 790 2910

ON Semiconductor Website: www.onsemi.com

Order Literature: <http://www.onsemi.com/orderlit>

For additional information, please contact your local Sales Representative