

FLUKE®

975
AirMeter™ Test Tool

Users Manual

PN 2507213

August 2006 Rev. 1, 12/11

© 2006-2011 Fluke Corporation. All rights reserved. Printed in U.S.A. Specifications subject to change without notice.
All product names are trademarks of their respective companies.

LIMITED WARRANTY AND LIMITATION OF LIABILITY

Each Fluke product is warranted to be free from defects in material and workmanship under normal use and service. The warranty period is 2 years and begins on the date of shipment. Parts, product repairs, and services are warranted for 90 days. This warranty extends only to the original buyer or end-user customer of a Fluke authorized reseller, and does not apply to fuses, disposable batteries, or to any product which, in Fluke's opinion, has been misused, altered, neglected, contaminated, or damaged by accident or abnormal conditions of operation or handling. Fluke warrants that software will operate substantially in accordance with its functional specifications for 90 days and that it has been properly recorded on non-defective media. Fluke does not warrant that software will be error free or operate without interruption.

Fluke authorized resellers shall extend this warranty on new and unused products to end-user customers only but have no authority to extend a greater or different warranty on behalf of Fluke. Warranty support is available only if product is purchased through a Fluke authorized sales outlet or Buyer has paid the applicable international price. Fluke reserves the right to invoice Buyer for importation costs of repair/replacement parts when product purchased in one country is submitted for repair in another country.

Fluke's warranty obligation is limited, at Fluke's option, to refund of the purchase price, free of charge repair, or replacement of a defective product which is returned to a Fluke authorized service center within the warranty period.

To obtain warranty service, contact your nearest Fluke authorized service center to obtain return authorization information, then send the product to that service center, with a description of the difficulty, postage and insurance prepaid (FOB Destination). Fluke assumes no risk for damage in transit. Following warranty repair, the product will be returned to Buyer, transportation prepaid (FOB Destination). If Fluke determines that failure was caused by neglect, misuse, contamination, alteration, accident, or abnormal condition of operation or handling, including overvoltage failures caused by use outside the product's specified rating, or normal wear and tear of mechanical components, Fluke will provide an estimate of repair costs and obtain authorization before commencing the work. Following repair, the product will be returned to the Buyer transportation prepaid and the Buyer will be billed for the repair and return transportation charges (FOB Shipping Point).

THIS WARRANTY IS BUYER'S SOLE AND EXCLUSIVE REMEDY AND IS IN LIEU OF ALL OTHER WARRANTIES, EXPRESS OR IMPLIED, INCLUDING BUT NOT LIMITED TO ANY IMPLIED WARRANTY OF MERCHANTABILITY OR FITNESS FOR A PARTICULAR PURPOSE. FLUKE SHALL NOT BE LIABLE FOR ANY SPECIAL, INDIRECT, INCIDENTAL, OR CONSEQUENTIAL DAMAGES OR LOSSES, INCLUDING LOSS OF DATA, ARISING FROM ANY CAUSE OR THEORY.

Since some countries or states do not allow limitation of the term of an implied warranty, or exclusion or limitation of incidental or consequential damages, the limitations and exclusions of this warranty may not apply to every buyer. If any provision of this Warranty is held invalid or unenforceable by a court or other decision-maker of competent jurisdiction, such holding will not affect the validity or enforceability of any other provision.

Fluke Corporation
P.O. Box 9090
Everett, WA 98206-9090
U.S.A.

Fluke Europe B.V.
P.O. Box 1186
5602 BD Eindhoven
The Netherlands

Table of Contents

Title	Page
Introduction.....	1
Features	1
Contacting Fluke	2
Safety Information	2
Symbols.....	3
Shipping Contents	4
Using the Meter	6
Using the Meter	6
Softkeys and Pushbuttons.....	6
Meter Power	7
Meter Power	7
Startup and Self Test.....	8
Automatic Backlight	9
Automatic Power Off.....	9
Multi-Language Interface	10
Measurement Units	10
Time and Date Stamp.....	10
CO Alarm.....	10

The Setup Menu	10
Taking Measurements	11
Temperature, Relative Humidity, CO, CO ₂ , Dew Point, and Wet Bulb Measurements	11
% Outside Air	11
% Outside Air (Temperature).....	12
% Outside Air (CO ₂)	12
Air Velocity and Volume Flow Rate	13
Standard Velocity and Actual Velocity	13
Velocity Probe	13
Measuring Air Velocity.....	13
Measuring Volume Flow Rate	14
Min Max Avg	15
Data Logging	15
Saving Single-Point Data	15
Continuous Data Logging.....	16
Logging Button Lockout	17
Recalling or Erasing Logged Data.....	18
Transferring Data to a Personal Computer	19
Calibration.....	20
Calibrating the CO and CO ₂ Sensors	20
Calibrating the CO Sensor	21
Calibrating the CO ₂ Sensor.....	21
Maintenance	24
Cleaning the Meter.....	24
Battery Maintenance and Battery Charge Indicators	24
Charging the Battery and Using the Power Adapter	25
Changing the AA Batteries	25

General Specifications	27
Calculated Parameters	28
Environmental Specifications.....	29
Physical Specifications	29
Agency Approvals, Certifications and Standards Compliance.....	30
Replaceable Parts and Accessories	30

List of Tables

Table	Title	Page
1.	Symbols.....	3
2.	975 Shipping Contents	5
3.	Softkeys and Pushbuttons.....	6
4.	Startup Failure Messages.....	9
5.	Gas for Calibration.....	20
6.	Replaceable Parts and Accessories.....	32

List of Figures

Figure	Title	Page
1.	975 Shipping Contents	4
2.	Softkeys and Pushbuttons.....	6
3.	AC Adapter Input and USB Port	8
4.	Calibration Set Up	23
5.	AA Battery Replacement and Kensington Lock Use	26
6.	Replaceable Parts and Accessories.....	31

975 *AirMeter™ Test Tool*

Introduction

Warning

Read “Safety Information” before using the 975 AirMeter™ Test Tool.

The Fluke 975 AirMeter™ Test Tool (“the Meter”) is a hand-held, five-sensor indoor air quality diagnostic instrument. It measures, calculates, and displays:

- Temperature, dew point, and wet bulb all measured in Celsius (°C) or Fahrenheit (°F).
- Relative humidity (%RH).
- Carbon monoxide (CO) levels measured in ppm.
- Carbon dioxide (CO₂) levels measured in ppm.
- Air velocity (standard and actual) measured in mps or fpm.
- % outside air based on temperature or CO₂.
- Flow rate displayed in m³/s or cfm.
- Absolute barometric pressure- shown at startup only.

- Minimum, maximum, and average readings for temperature, relative humidity, wet bulb, dew point, velocity, CO, and CO₂.

Features

Detailed explanations of the Meter features appear later in this manual. The Meter comes with the following features:

- Automatic backlight
- Auto power off
- Rechargeable lithium battery, ac power, or backup power supply of three AA batteries
- DC power supply with available international adapters
- Multi-language user interface (English, French, German, Portuguese, and Spanish)
- US and Metric measurement options
- Time and date stamp (12-hour or 24-hour)
- Single-point and continuous data logging options
- CO alarm
- Detachable velocity probe (optional)

- FlukeView® Forms software with USB cable for downloading stored data
- Hard shell carrying case
- Protective holster
- Calibration cap and tubing
- Calibration certificate for NIST traceability
- Kensington lock-ready. See Figure 5.

Contacting Fluke

To contact Fluke, call one of the following telephone numbers:

- Technical Support USA: 1-800-44-FLUKE (1-800-443-5853)
- Calibration/Repair USA: 1-888-99-FLUKE (1-888-993-5853)
- Canada: 1-800-36-FLUKE (1-800-363-5853)
- Europe: +31 402-675-200
- Japan: +81-03-6714-3114
- Singapore: +65-738-5655
- Anywhere in the world: +1-425-446-5500

Or, visit Fluke's website at www.fluke.com.

To register your product, visit <http://register.fluke.com>.

To see, print, or download the latest manual supplement, visit <http://us.fluke.com/usen/support/manuals>.

Safety Information

A **Warning** identifies a condition or action that pose hazard(s) to the user; a **Caution** identifies a condition or action that may damage the Meter or the equipment under test.

Warning

To avoid injury, or damage to the Meter, follow these safety guidelines:

- Read the entire users manual before using the Meter.
- Use the Meter only as described in the Users Manual otherwise the protection provided by the equipment may be impaired.
- Inspect the Meter before use. Do not use it if it appears damaged.
- The Meter contains no user-serviceable parts. Do not open the instrument. For service and rechargeable-battery replacement, the instrument must be sent to Fluke. See “Contacting Fluke”.
- Have the Meter serviced only by qualified service personnel.
- Always use the ac adapter/charger and connector (supplied with the Meter) appropriate for the voltage and outlet of the country or location in which you are working.







Caution

To avoid possible damage to the Meter, avoid using the Meter in an excessively dirty or dusty atmosphere. Excessive particle intake can damage the Meter.

Symbols

Symbols used in this manual and on the Meter are displayed in Table 1.

Table 1. Symbols

Symbol	Meaning
	Risk of danger. Important information. Refer to manual.
	Hazardous voltage. Risk of electrical shock.
CE	Conforms to relevant European Union directives
	Conforms to Australian Standards
	The Meter battery contains Lithium. Do not dispose of this battery as unsorted municipal waste. Contact Fluke or a qualified recycler for disposal.
	Do not dispose of this product as unsorted municipal waste. Contact Fluke or a qualified recycler for disposal.
 RC	Rechargeable battery symbol
 AA	Backup battery symbol

Shipping Contents

The Meter ships with the items shown in Figure 1 and listed in Table 2.

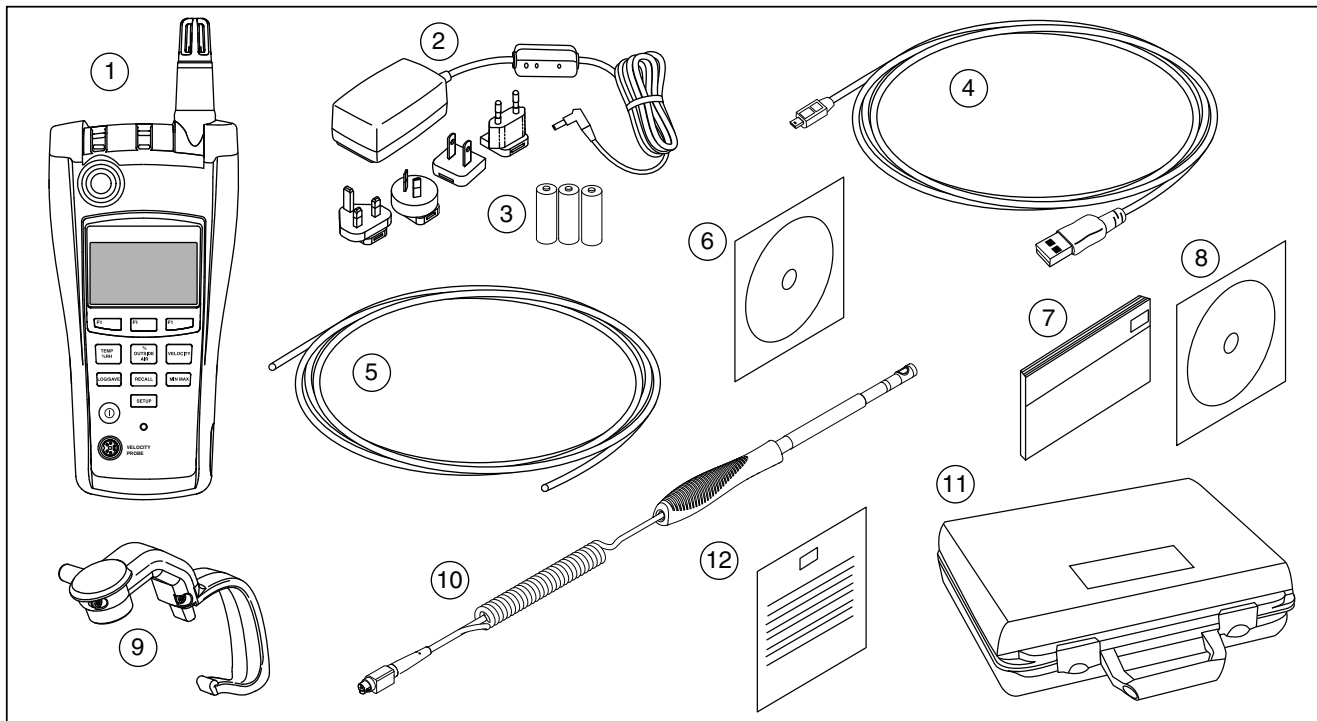

Figure 1. 975 Shipping Contents

eba07f.eps

Table 2. 975 Shipping Contents

Item	Description	Item	Description
①	975 AirMeter™ Test Tool and Holster	⑦	Users Manual (printed, English)
②	AC Adapter/Charger with type A, C, G and I adapters to fit most countries.	⑧	<i>975 Manuals CD</i> containing the Users Manual in English, French, German, Portuguese, Spanish, and Simplified Chinese
③	Three AA batteries (backup power supply)	⑨	CO and CO ₂ calibration cap
④	USB cable	⑩	Velocity probe (optional)
⑤	Tubing for calibration	⑪	Hard shell carrying case
⑥	FlukeView® Forms software CD and documentation	⑫	Calibration certificate

Using the Meter

The following sections explain how to use the Meter and its features.

Softkeys and Pushbuttons

Use the softkeys to navigate among different menus or to select different functions. Softkeys **F1**, **F2**, and **F3** correspond to prompts in the lower section of the display. Refer to Figure 2 and Table 3. Use the pushbuttons to select different Meter functions.

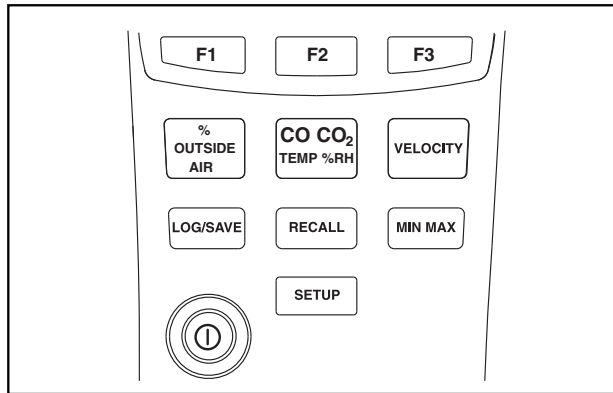

eba01.eps

Figure 2. Softkeys and Pushbuttons

Table 3. Softkeys and Pushbuttons

Softkey or Pushbutton	Function
F1 F2 F3	Softkeys - Each softkey corresponds to prompts on the lower section of the display. The prompts change depending on what function menu is used.
CO CO ₂ TEMP %RH	CO and CO₂ Temperature/ % Relative Humidity - Activates the Temperature, Relative Humidity, CO and CO ₂ , Wet Bulb, and Dew Point functions.
% OUTSIDE AIR	% Outside Air - Activates the % Outside Air menu. See “% Outside Air”.
VELOCITY	Velocity -When used with the optional Velocity Probe, this activates the Air Velocity and Volume Flow Rate menus. See “Air Velocity and Volume Flow Rate”.
LOG/SAVE	Log/Save - Activates the Log/Save menus. See “Data Logging”.
RECALL	Recall - Press this button to access the Logged Data menu. See “Recalling or Erasing Logged Data”.
MIN MAX	MIN MAX - Activates the Min Max Avg function. See “Min Max Avg”.
I	Power - Turns the Meter on and off.
SETUP	Setup - Press to enter the Setup menu. See “The Setup Menu”.

Meter Power

Warning

To avoid electrical shock or personal injury, always match the line cord to the instrument.

- Use the line cord supplied for this instrument with this instrument only.
- Do not use this line cord with any other instruments.
- Do not use any other line cords with this instrument.
- Use the proper line cord and adapter for your country.
- Do not replace the Lithium battery. For Lithium battery replacement, the Meter must be sent to Fluke. See “Contacting Fluke”.

The Meter is powered by a rechargeable lithium battery, a supplied ac adapter, or three AA batteries used as a backup power supply. See Figure 3 to locate the ac power input.

Note

Before the rechargeable battery can be used, it must first be charged for several hours. If immediate Meter use is necessary, the backup batteries or the line cord can be used.



Note

This Meter contains a lithium battery.

Do not mix with the solid waste stream. Spent batteries should be disposed of by a qualified recycler or hazardous materials handler.

Contact your authorized Fluke Service Center for recycling information.

A fully-charged Meter operates for 11 hours. The backup power supply lasts 7 hours.

See “Maintenance” for information on how to charge the Lithium battery and how to change the AA batteries.

Note

The adapter/charger includes adapters that fit receptacles in most countries.

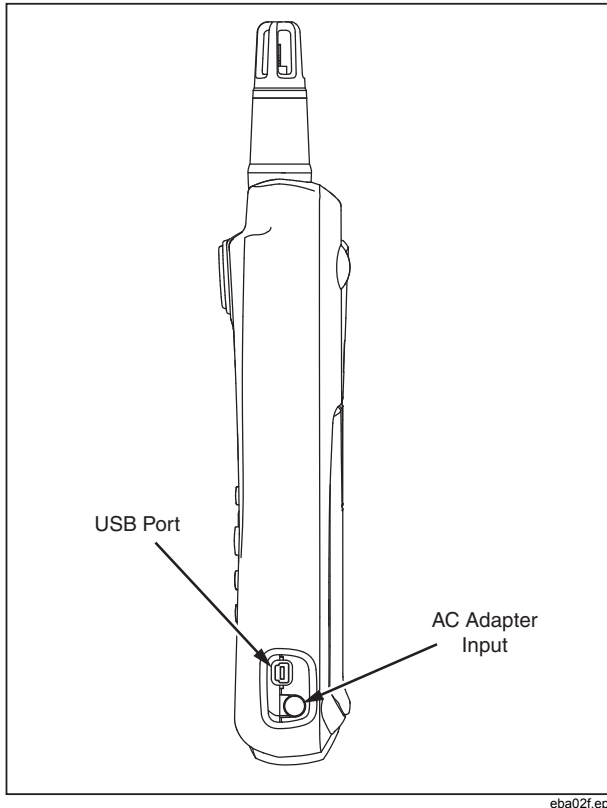

Figure 3. AC Adapter Input and USB Port

Startup and Self Test

To turn the Meter on, press and hold **ⓘ** for a few seconds and wait for the flashing red LED on the left side of the display. Press **ⓘ** for 2 seconds to turn the Meter OFF. Once powered up, the following information is displayed:

- Battery charge indicators
- Model number of the Meter (975)
- Firmware version number
- Current date
- Last calibration date
- Calibration due date
- Absolute barometric pressure
- Self-test countdown

At power up, the Meter performs a 35-second self-diagnostic test for each of its functions. When it passes the self-test, the Meter is ready for use. Refer to Table 4 for a list of self-diagnostic test failures.

Note

If portions of the self-test fail, some functions of the Meter may still be used but this is not recommended. Have the Meter serviced immediately. Refer to "Contacting Fluke" for service details.

Table 4. Startup Failure Messages

Failure Message	Action
Temperature Sensor: FAIL Humidity Sensor: FAIL	Have the Meter serviced. The Meter may still be used. Wet bulb, Dew point, Temperature and Humidity functions are unavailable. CO or CO ₂ readings are inaccurate.
CO: FAIL CO₂: FAIL	Have the Meter serviced. The Meter may still be used. CO or CO ₂ functions are unavailable. If either sensor fails, then calculations are incomplete.
⚠ SELF TEST: FAILED Please Service Instrument	Have the Meter serviced. The Meter has internal failures. Message appears until the Meter is serviced.
Battery Empty System is Shutting Down...	If the battery is below minimum charge, the Meter shuts down until the battery is recharged or the Meter is connected to ac power. See "Battery Maintenance".
PROBE ERROR	Problem with the Velocity probe or the connection. Remove and reattach the probe. If the problem continues, have the probe serviced.
⚠ Calibration OVERDUE Please Refer to Manual	Calibrate the Meter. Calibration date for the Meter has passed. See "Calibration".

Note

The Meter settling time is less than 1 minute. Severe changes or differences in temperature between the Meter and the measuring environment may require more settling time.

Automatic Backlight

The Meter's backlight senses low-light conditions and automatically turns on when necessary. The backlight turns off after 30 seconds of Meter inactivity. To turn it back on, press any button. The button pressed will not activate its normal function. In low light, any button pressed will turn the backlight on for 30 seconds. See "The Setup Menu" to disable the auto backlight off.

Automatic Power Off

To conserve battery power, the Meter goes into sleep mode after 20 minutes of non-use and remains in this mode for 12 hours. After 12 hours in sleep mode, the Meter completely shuts down. Use the Setup menu to disable this function or to select 30 or 60 minute time out periods. See "The Setup Menu". Automatic power off is disabled during logging.

Multi-Language Interface

The Meter's display supports five languages: English, French, German, Portuguese, and Spanish. Use the Setup menu to change the display language. See "The Setup Menu".

Measurement Units

The Meter supports both Metric and US measurement units. Select the desired measurement format using the Setup menu. See "The Setup Menu".

Time and Date Stamp

The Meter features an on-board, user settable clock that logs the time and date for each captured reading. The current date is displayed when the Meter is powered on. The Meter continues to keep time when it is powered off. To change the time and date format, see "The Setup Menu".

CO Alarm







The Meter is equipped with a CO alarm. By default, the alarm is reset to 35 ppm every time the Meter is turned off. Using the Setup Menu, set the alarm threshold anywhere from 1 ppm to 200 ppm. When the amount of carbon monoxide exceeds the limit, the alarm triggers. The Meter emits an audible alarm and a red LED flashes. See "The Setup Menu".

The Setup Menu

Use the Setup menu to change the following Meter parameters:

- Set Time
- Set Time Format: 12 or 24 hour modes
- Set Date
- Set Date Format: M/D/Y or D/M/Y
- Temperature Scale: °C or °F
- Measurement Units: Metric or US
- CO Alarm: specifies measurement at which the alarm sounds from 1 ppm to 200 ppm
- Auto Power Off
- Calibration Cycle (1-365 days) [user-configurable]
- Backlight: enables or disables auto backlight off
- Language: the user interface language can be changed to English, French, German, Portuguese, or Spanish.
- Keypad Beep: enables or disables the keypad beeper. The CO alarm is not affected.

To modify the Meter setup parameters:

1. From any screen, press  to enter the Setup menu editing mode.
2. Press  [ Item] and  [ Item] to highlight a listed setup item.
3. Press  [Select] to make the desired item active.

4. Press **F1** and **F2** as necessary to change the item values. Hold down **F1** or **F2** to increase the rate of change.
5. Press **F3** [Select], or in some cases [Done], to store the changes.
6. Press **SETUP** for 2 seconds to exit the Setup menu. All changes are stored.

Taking Measurements

The Meter measures:

- Temperature, Dew Point, and Wet Bulb
- Relative Humidity (%RH)
- Carbon monoxide (CO) levels
- Carbon dioxide (CO₂) levels
- % Outside Air
- Air Velocity (standard and actual)
- Flow Rate

Temperature, Relative Humidity, CO, CO₂, Dew Point, and Wet Bulb Measurements

When the Meter completes and passes its self-test, it is ready to take temperature, relative humidity, CO, CO₂, dew point, and wet bulb readings. If the Meter is displaying another function menu, press **CO CO₂ TEMP/RH**.

Temperature, relative humidity, CO, and CO₂ readings are shown on this screen.

- Dew point is the temperature at which condensation starts. To view the dew point from the main menu,

press **F1** [Dew Point]. The dew point reading appears on the top right of the display.

- Wet bulb temperature is the lowest temperature that evaporating water can reach. To view the wet bulb temperature from the main menu, press **F3** [Wet Bulb] (or **F1** [Wet Bulb] if the Meter is displaying dew point temperature). The wet bulb reading appears on the top right of the display.

From either the wet bulb or dew point screens, press **F3** [Main] to return to the main screen.

% Outside Air

Air conditioning systems rely on outside air, mixed air, and return air to help cool, heat, or purify their output. A balance of the three is also a factor in achieving optimum-energy usage from the conditioning unit.

The Meter's Percentage (%) Outside Air function computes the percentage of outside air two different ways, either by measuring temperature or by measuring CO₂ content.

The formula for calculating % outside air is:

$$\% \text{ Outside Air} = \frac{\text{Return Air} - \text{Mixed Air}}{\text{Return Air} - \text{Outside Air}} \times 100 \%$$

Return Air – Outside Air













Determining the % outside air requires entering values for return air, outside air, and mixed air into the formula.

These values can be in temperature or CO₂ content. The values can be measured with the Meter or, in the case of outside air, can also be entered manually. Once the

variables are known, the Meter computes the % outside air.

% Outside Air (Temperature)

To obtain % of outside air using temperature:

1. Place the Meter sensor perpendicular to the air stream being measured.
2. Press . The Meter switches to % outside air measuring mode and offers choices of  [CO₂] or  [Temp].
3. Press  [Temp]. The Meter measures and displays the return air temperature.
4. Press  [Capture] to store the return air reading. The Meter then measures and displays the mixed air temperature.
5. Press  [Capture] to store the mixed air reading. The Meter then measures and displays the outside air temperature.
6. Outside air temperature can either be measured by using  [Capture] or it can be entered manually by pressing  [Manual Entry] and entering the known outside air temperature value. When entering manually, use  [UP] and  [DOWN] to change the temperature reading to the desired number. Press  [ENTER].
7. Once the outside air temperature is entered, return air, mixed air, and outside air temperatures are displayed. Press  [Calculate] to show the %









outside air, or press  [Back] to change any of the measurements.

8. Press  [Done] to end the % outside air measurement.

% Outside Air (CO₂)

Measuring the % outside air using carbon dioxide (CO₂) is similar to measuring the percentage of outside air via temperature.

To obtain the % outside air using CO₂:

1. Place the Meter sensor perpendicular to the air stream being measured.
2. Press . The Meter switches to the % outside air measuring mode and offers the selection choice of  [CO₂] or  [Temp].
3. Press  [CO₂]. The Meter measures and displays the return air CO₂ content.
4. Press  [Capture] to store the return air reading. The meter then measures and displays the mixed air CO₂ content.
5. Press  [Capture] to store the mixed air reading. The Meter then measures and displays the outside air CO₂ content.
6. Outside Air CO₂ content can either be measured by using  [Capture] or it can be entered manually by pressing  [Manual Entry] and entering the known outside CO₂ content. When entering manually,

use **F2** [UP] and **F3** [DOWN] to change the CO₂ content reading to the desired number. Press **F1** [ENTER].

- Once the outside air CO₂ content is entered, return air, mixed air, and outside air CO₂ content are shown in parts per million (ppm). Press **F1** [Calculate] to show the % outside air or press **F3** [Back] to change any of the measurements.
- Press **F3** [Done] to end the % outside air measurement.

Air Velocity and Volume Flow Rate

Note

The optional Velocity Probe is required for Velocity readings.

The Meter measures air velocity and volume flow rate to determine the overall velocity reading. Standard and Actual velocity readings are available.

Standard Velocity and Actual Velocity

Standard Velocity is the velocity that air moves if temperature and pressure are compared to standard conditions. Standard conditions for the Meter are 21.1 °C (69.98 °F) and 101.4 kPa (29.93 in Hg).

Actual Velocity is standard velocity which is adjusted using ambient barometric and temperature conditions.

Velocity Probe

When measuring velocity, the velocity probe must be connected to the Meter. If the probe is not connected or it fails the self test, the velocity feature is disabled. The Meter alerts the user to either attach the probe or that there is a probe error.

Note

The velocity probe takes approximately one minute to warm up.

Measuring Air Velocity

Note

To measure standard or actual air velocity the steps are the same with the exception of entering the standard or actual velocity menu.

To measure velocity:

- Attach the velocity probe.
- Press **VELOCITY** to enter the velocity menu. The probe will initialize.
- Press **F3** [Air Velocity].
- Place the wand sensor perpendicular to the air stream being measured.

Note

The white dot on the probe MUST face into the air stream for accurate readings.

5. Press **F2** [Capture] to capture the standard velocity reading, **F1** [Actual] to change to the actual velocity menu, or **F3** [Back] to return to the velocity menu.

Note

*In this case, pressing **F2** [Capture] does not create a single point data log, it simply freezes the display reading.*

6. If the standard reading was captured, press **F1** [Actual] to view the actual air velocity reading.
7. Press **F3** [Done] to return to the velocity menu.

Measuring Volume Flow Rate

The formula for measuring the air flow volume rate is to multiply the area of the air-duct opening by the average velocity of the air. The Meter does the computation after the variables are entered.

To measure the volume flow rate:

1. Attach the velocity probe.
2. Press **VELOCITY** to access the velocity menu. The probe will initialize.
3. Press **F1** [Volume Flow Rate].
4. The volume flow rate screen appears. Select the duct type matching that being measured:
 - **F1** [Rectangle Duct]
 - **F3** [Round Duct]
 - **F2** [Other] to manually enter the area number

Choose measurement units in inches (if the Meter is set to Metric measurements, enter units in centimeters).

5. Enter the duct measurements:
 - If **F1** [Rectangle Duct] is pressed, enter the x (length) and y (height) measurements using the up and down arrows. Press **F3** [ENTER X] or [ENTER Y] once each measurement is entered.
 - If **F3** [Round Duct] is pressed, use the up and down arrows to enter the duct's diameter.
6. Place the wand sensor perpendicular to the air stream being measured with the white dot facing into the air stream.
7. Press **F1** [Capture]. The standard velocity flow rate measurement is displayed. Continue capturing samples as needed.

Note



The Meter can take up to 99 samples.

8. When all samples have been captured, press **F3** [Calculate Flow]. The standard velocity volume flow rate is displayed.
9. Press **F2** [Actual] to view the actual velocity volume flow rate.
10. Press **F3** [Back] to return to the flow rate sample.
11. Press **F1** [Done] to return to the Velocity menu.

Min Max Avg

The Min Max mode stores minimum (MIN) and maximum (MAX) input values. When the input drops below the stored minimum value or above the stored maximum value, the Meter beeps and stores the new value. Min Max mode also calculates an average (AVG) of all readings taken since the mode was activated.

Min Max mode works with Temperature, CO, CO₂, Relative Humidity, Dew Point, Wet Bulb, and Air Velocity.

To use Min Max mode, press . The maximum reading appears first. Each subsequent press of  steps through the minimum, average, and live readings, and back to the maximum reading.

To deactivate Min Max mode, hold  for approximately two seconds.

Data Logging

The Meter logs discrete (single-point) or continuous data. Data logs are viewed on the Meter or can be uploaded to a PC running FlukeView® Forms software. Refer to “Transferring Data to a Personal Computer” for more information.

Saving Single-Point Data

The Meter is able to save single-point data logs in non-volatile flash memory.

Single-point data logs list measured parameters, calculated duct volume flow rates, or % outside air.

Single-point logs include:

- Sample ID (1-99)
- Temperature
- Relative Humidity
- Wet Bulb
- Dew Point
- CO
- CO₂
- Time/date stamp

Velocity, duct volume flow rate and % outside air logs include:

- Sample ID (1-99)
- Time/date stamp
- Velocity (actual or standard) or calculated duct volume flow rate, or % outside air calculation results

To save single-point data:

1. Take a desired measurement.
2. Press **LOG/SAVE**. The Log/Save menu appears on the display. The measurement that was displayed when **LOG/SAVE** was pressed is the measurement that will be saved.
3. Press **F3** [Save Data]. The Meter shows **“Saving...”**.
4. The data is saved and the Meter returns to the screen where the data originally was taken.

Note

Press **F2** [Cancel] to cancel data saving and to exit the Log/Save menu. All other keys are inoperative while logging.

When the Meter's storage memory is full, the entire memory must be erased to make room for more data. See *“Recall or Erasing Logged Data”*.

Values displayed using Min, Max, or Avg functions cannot be logged. However, FlukeView[®] Forms will display Min, Max, and Avg for single-point and continuous logged data.

Continuous Data Logging

Continuous data logging stores records in non-volatile flash memory.

Continuous data logs include:

- Session number
- Temperature
- Relative humidity
- Wet bulb
- Dew point
- CO
- CO₂
- Air velocity (if the probe is connected)
- Time/date stamp
- Sample ID/total number of samples

Logging can automatically save data taken over a period of minutes or up to 99 hours. Up to 25,000 records can be stored. To begin a logging session:

1. Start a desired measurement.
2. Press **LOG/SAVE**. The Log/Save menu appears on the display.
3. Press **F1** [Start Logging].
4. Use **F2** [UP] or **F1** [DOWN] to change the duration time. Press **F3** [ENTER] to advance to the next changeable parameter.

5. Once the desired parameters have been entered, the display shows the selected duration time, sampling interval, and the available memory %.
6. The Meter requests user confirmation before starting a logging session:
 - Press **F1** [Yes] to confirm the settings and begin logging.
 - Press **F2** [Adjust] to change logging parameters.
 - Press **F3** [Cancel] to return to exit the logging mode.

The Meter logs the sessions until stopped or the logging interval has expired. To stop logging, press **F2** [Stop]. All other keys are inoperative while logging.

Notes

- *When continuously logging data, the logs are stored using the selected measurement units (Metric or US). To change units, logging must be stopped and a new log created.*
- *If the Meter memory is full, the memory must be cleared or the parameters of the measurement must be changed to accommodate the new readings. Follow the on-screen prompts to make adjustments.*
- *The Meter cannot be turned off while in logging mode. Logging must be completed or **F2** [Stop] must be pressed to cancel logging prior to turning the Meter off.*

Logging Button Lockout

The Meter has an automatic and manual button lockout feature to prevent accidental button pushes during a continuous logging session.

During logging, the automatic button lockout is engaged and only **F2** [STOP] is active which will end logging.

To manually lock the entire keypad, press **MIN MAX**, **SETUP**, and **CO CO₂ TEMP %RH** simultaneously for 3 seconds. All buttons will be inoperative until the button sequence is repeated.

Recalling or Erasing Logged Data

Use the Recall function to retrieve or erase the single point or continuous logging session records.

To view single points of data:

1. Press **RECALL** to show the Recall menu.
2. Press **F3** [Single Point]. Detailed sessions appear on the display starting with the most recent sample.
3. Press **F1** [Next] or **F2** [Previous] to move the cursor to the previous or next detailed sample.
4. If the velocity probe is attached, press **F3** to access the velocity section of the sample.

To view logged sessions:

1. Press **RECALL** to show the Recall menu.
2. Press **F1** [Logged Sessions]. Logged sessions appear on the display starting with the most recent session.
3. Press **F1** [Next] or **F2** [Previous] to move the cursor to the previous or next detailed session.

Listed session parameters are:

- Session number
- Temperature
- Relative Humidity
- Wet Bulb
- Dew point
- CO

- CO₂
 - Sample ID/total number of samples
 - Time/Date stamp
 - Velocity (push **F3** for access)
4. Press **F1** [Next Sample] or **F2** [Previous Sample] to move to the next or previous session.

To escape recall mode, press **% OUTSIDE AIR**, **CO CO₂ TEMP**, or **VELOCITY**.

To erase single points or logged sessions:

1. Press **RECALL** to show the Recall menu.
2. Press **F2** [Erase Memory].
3. Press **F1** [Item] to choose either **Single Data Points** or **Continuous Logged Sessions**.
4. Press **F2** [Erase Memory].
5. Press **F1** [YES] to confirm that the memory is to be erased or **F3** [Cancel] to abort erasing any data.

Transferring Data to a Personal Computer

Data that is collected and stored in the Meter's memory can be downloaded to a personal computer (PC) using the included *FlukeView® Forms Documenting Software* and USB cable. See Figure 3 to locate the USB port on the Meter. To install the software, see the "*FlukeView® Forms Installation Guide*" that comes with the software.

Notes

- *The Meter cannot measure or log data while the USB cable is connected.*
- *Before the USB cable can be used with the Meter, the Meter software drivers must be installed on a PC running Windows XP or 2000. These drivers are available on the *FlukeView® Forms Documenting Software* Version 3.2 software CD.*

To transfer data from the Meter to the computer:

1. Install *FlukeView® Forms Documenting Software* on the PC. (See Installation Guide).
2. Connect the USB cable to the Meter and to an open USB port on the PC.
3. Power up the Meter if it is not already on.
4. Windows should show that it's found new hardware and will ask for new drivers. Point to the *FlukeView® Forms* CD.
5. Open *FlukeView® Forms Documenting Software*.

6. The current COM serial port setting is displayed at the bottom right of the *FlukeView® Forms* window. Double-click it to change the COM port setting to the virtual COM port used by the USB cable.
7. Transfer data from the Meter to the PC by following the instructions found in the online *FlukeView® Forms Users Manual*.

Notes

- *To locate the PC COM port that is used by the Meter:*
 1. *Select **Start/Settings/Control Panel** from the PC desktop task bar.*
 2. *From the control panel, select **System/Hardware** then **Device Manager**.*
 3. *From the Device Manager, select **Ports (COM & LPT)**, note which COM port the Meter is connected to.*
- *To ensure no data is lost, verify that the download was successful before deleting the stored test results on the Meter.*
- *Data stored in the Meter can be deleted from the PC using the *FlukeView® Forms* application. See the *FlukeView® Forms Users Manual* file for details.*

Calibration

Calibration due dates are tracked using the Meter's clock and stored in non-volatile memory. Due dates can be configured by the user from one to 365 days. When the Meter reaches its calibration due date, it alerts the user but will continue to operate.

The Meter's CO and CO₂ sensors can be calibrated by the user or returned to Fluke for service. See "Contacting Fluke". The recommended calibration interval is 1 month for CO and 1 year for CO₂.

Gas Canister and Regulator can be purchased from any Calibration Gas Supplier allowing the users to calibrate the CO and CO₂ sensors.

Install the calibration cap and attach the hose to the correct gas canister; mixed CO and CO₂ for calibration gas, Nitrogen for zeroing gas when calibrating CO₂. See Figure 4.

Note

Calibration gas is applied at the rate of ½ liter/minute for 2 minutes.

Regulator requirement: 0.5 liters/minute flow rate.

For gas used for calibration, see Table 5.

Table 5. Gas for Calibration

	Nominal ppm	Min ppm	Max ppm
CO	200	150	250
CO ₂	5000	4500	5000

Calibrating the CO and CO₂ Sensors

Calibrate the CO and CO₂ sensors together, or separately.

To simultaneously calibrate both sensors,

1. If not already in calibration mode, press **LOG/SAVE**, **RECALL**, and **SETUP** simultaneously for 3 seconds to enter calibration mode.
2. Press **F1** [Yes] to initiate the calibration procedure.
3. Press **F3** [BOTH].

The Meter display reads:

Calibration Procedure

Apply Nitrogen...

4. Apply ½ litre/minute of nitrogen for 2 minutes. Press **F3** [Cancel] to exit calibration.

- When sensor zero is complete, remove the nitrogen and press **F2** [OK] or **F3** [Cancel] to exit calibration.

The Meter displays:

Apply CO Calgas concentration...

- Enter the concentration amount using **F1** [DOWN] and **F2** [UP] to change the entry and **F3** [ENTER] to store it.
- Apply the calibration gas mixture of CO and CO₂. Press **F2** [OK] or **F3** [Cancel] to exit calibration.
- When finished, remove gas and press **F3** [OK]. Enter the time to next calibration date. Use **F1** [DOWN] and **F2** [UP] to change the number and **F3** [ENTER] to store the number.

The calibration procedure is complete.

Calibrating the CO Sensor

To calibrate the CO sensor:

- With the calibration cap on, press **LOG/SAVE**, **RECALL**, and **SETUP** simultaneously for 3 seconds to enter calibration mode.
- Press **F1** [Yes] to initiate the calibration procedure or press **F3** [Cancel] to exit calibration mode.

- Press **F1** [CO]. The Meter zeros the CO sensor. If desired, press **F3** [Cancel] to abort Meter calibration.
- Use **F1** [DOWN] and **F2** [UP] to change the gas concentration (ppm). Press **F3** [ENTER] to enter the concentration level.
- The Meter prompts to apply the CAL Gas. Attach the mixed CO and CO₂ calibration gas canister to the Meter via the supplied hose or press **F3** [SKIP] to exit.
- The Meter calibrates the CO sensor. Press **F3** to cancel. When finished, remove gas and press **F3** [OK]. Enter the time to next calibration date. Use **F1** [DOWN] and **F2** [UP] to change the number and **F3** [ENTER] to store the number.

Note

When either CO or CO₂ sensors are calibrated, the calibration date is reset by the user.

CO calibration is now complete and the Meter exits calibration mode.

Calibrating the CO₂ Sensor

To calibrate the CO₂ sensor:

- If not already in calibration mode, with the calibration cap on, press **LOG/SAVE**, **RECALL**, and **SETUP** simultaneously for 3 seconds to enter calibration mode.
- Press **F1** [Yes] to initiate the calibration procedure or press **F3** [Cancel] to exit calibration mode.

3. Press [CO₂].
4. Specify one-point or two-point calibration methods. The one-point method uses CAL gas only. The two-point method uses CAL gas and also Neutral gas (Nitrogen).

If one-point is chosen:

- a. Use [DOWN] and [UP] to choose the CAL gas concentration.
- b. Press [ENTER] to enter the concentration.
- c. Apply the CAL gas and press [OK], press [SKIP] to exit calibration mode. The Meter will now calibrate the CO₂ sensor for 2 minutes. Press [Cancel] to exit calibration mode. If calibration fails, repeat the procedure. If it fails a second time, have the Meter serviced.
- d. The Meter finishes the procedure then prompts the user to enter the time until the next calibration. Enter the amount using [DOWN] and [UP] to change the number and [ENTER] to store the number.

If two-point is chosen:

- a. Apply the neutral gas (Nitrogen) or press [Cancel] to exit calibration mode.
- b. When zeroing is complete, remove neutral gas (Nitrogen) and press [OK] or [Cancel] to exit calibration mode.
- c. Apply the CAL gas. Enter the amount using [DOWN] and [UP] to change the number and [ENTER] to store the number.
- d. Apply cal gas and press [OK] or [Cancel] to exit calibration mode.
- e. The Meter finishes the procedure then prompts the user to enter the time until the next calibration. Enter the amount using [DOWN] and [UP] to change the number and [ENTER] to store the number.

CO₂ sensor calibration is now complete and the Meter exits calibration mode.

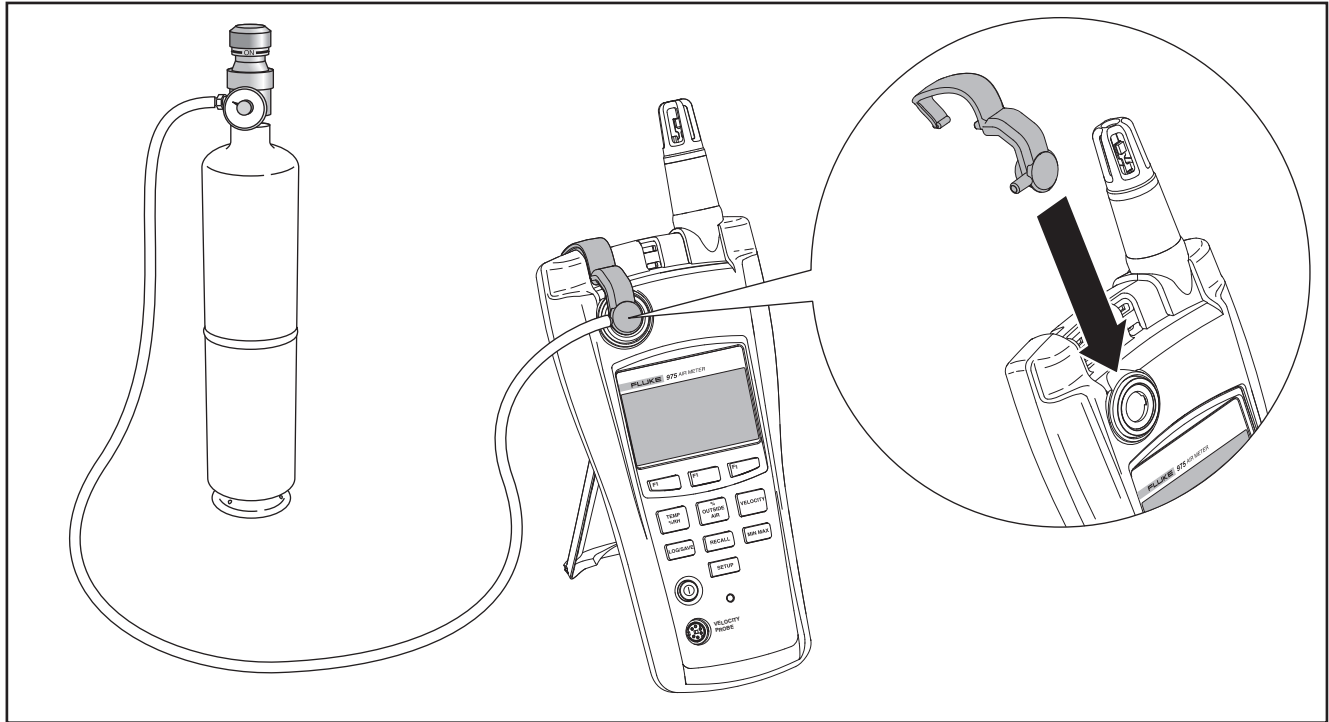

Figure 4. Calibration Set Up

eba09f.eps

Maintenance

Warning

The Meter contains no user-serviceable parts. To avoid electric shock, injury, or damage to the Meter, do not open the case. For service and rechargeable battery replacement, the Meter must be sent to Fluke. See “Contacting Fluke”.

Cleaning the Meter

Periodically wipe the case and holster with a damp cloth and mild detergent.



Caution

To avoid damaging the Meter, do not use abrasives or solvents to clean the Meter case.









Battery Maintenance and Battery Charge Indicators

The Meter normally uses a rechargeable battery but is equipped with three AA batteries for backup power. The following sections explain how to charge or change the batteries.

Battery charge indicators for both the rechargeable battery and the backup power supply appear on the display at start up. Use these indicators to assess the battery charge:

 RC  AA – Rechargeable battery and backup batteries are fully charged.

When both the rechargeable battery and the backup supply are installed in the Meter, the battery indicators display as follows:

-  RC – After the startup period, the indicators disappear until the rechargeable battery reaches 25 % of charge capacity.
-  RC  AA – When the rechargeable battery reaches 10 % of charge capacity, both icons appear.
-  RC  AA – When the rechargeable battery reaches 0 % of charge capacity, the rechargeable battery icon flashes.
-  RC  AA – When the rechargeable battery reaches 0 % of charge capacity, and the backup supply reaches 25 % of charge capacity, both icons flash.
-  RC  AA – When the rechargeable battery reaches 0 % of charge capacity, and the backup supply reaches 10 % of charge capacity, both icons flash.

When the Meter's rechargeable battery and backup supply are at 0 % of charge capacity, the Meter displays the following message:

**Battery Empty
System is
Shutting Down...**

The Meter then shuts itself off.

The battery indicators act differently when the backup supply is not present.

When only the rechargeable battery is in use, the battery indicators display as follows:

- When the rechargeable battery is completely charged, the indicator shows only at startup.
- RC – Rechargeable battery charge is at 25 % of capacity.
- RC – Rechargeable battery charge is at 10 % of capacity (flashing).

Charging the Battery and Using the Power Adapter



This Meter contains a rechargeable lithium battery that cannot be serviced by the user.

Do not mix this battery with the solid waste stream. Spent batteries should be disposed of by a qualified recycler or hazardous materials handler.

Contact your authorized Fluke Service Center for recycling information.

The ac adapter is used to recharge the battery as well as power the Meter. This feature allows the Meter to be used while the battery is charging. Allow 2 hours to fully recharge the battery.

To connect the ac adapter/charger, see Figure 3:

1. Plug the charger into the dc jack on the base of the Meter.
2. Using the correct adapter for your country, plug the ac adapter into an ac outlet.

Changing the AA Batteries

To change the AA batteries used for backup power. See Figure 5. To replace the lithium battery, return the Meter to Fluke. See “Contacting Fluke”.

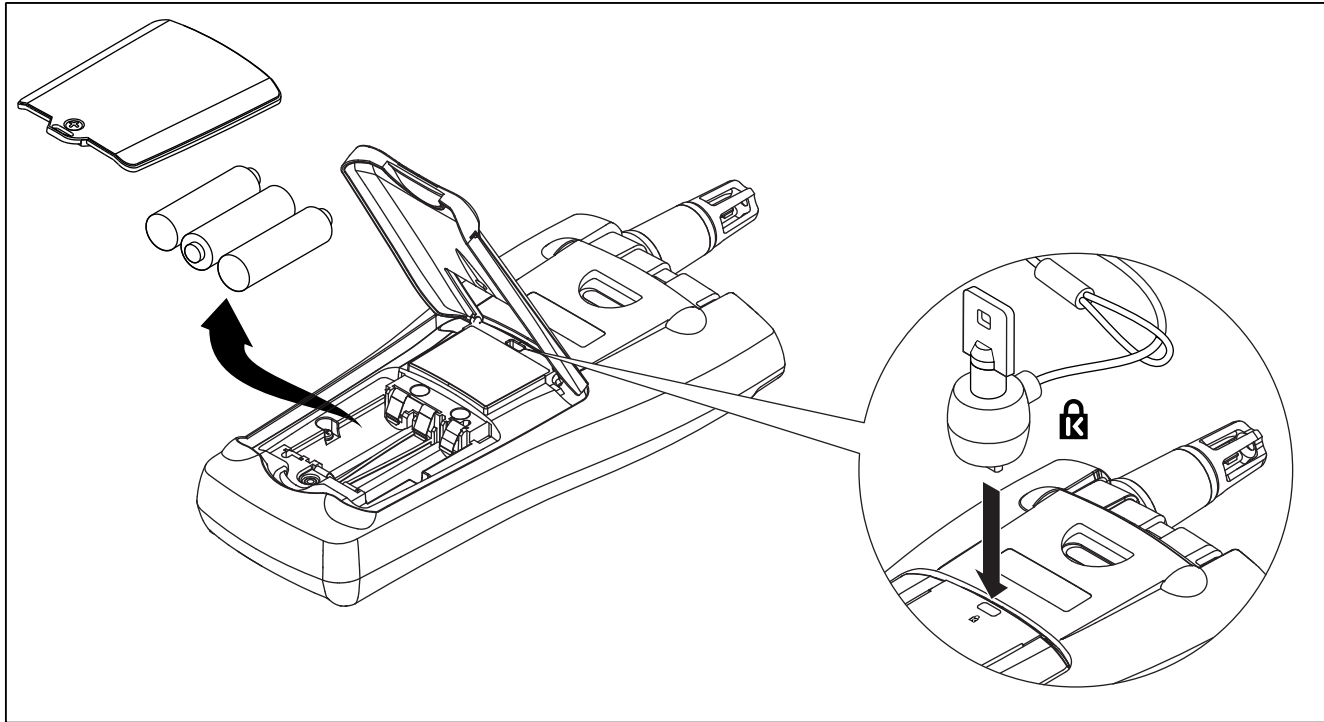

Figure 5. AA Battery Replacement and Kensington Lock Use

eba08f.eps

General Specifications

Measured Parameters	Range	Display Resolution	Accuracy % of Reading
Temperature	-5 ° to 122 °F -20 ° to 50 °C	0.1 °F 0.1 °C	±0.9 °C /±1.62 °F from 40 °C to 50 °C ±0.5 °C /±1.00 °F from 5 °C to 40 °C ±1.1 °C /±1.98 °F from -20 °C to 5 °C
Relative Humidity	10 to 90 % R.H. non-condensing	0.1 %	±3 % RH from 10 % RH to 90 % RH Includes 1 % hysteresis
Air Velocity	50 to 3000 fpm 0.25 to 15 m/sec	1 fpm 0.001 m/sec	±4 % or 4 fpm* ±4 % or .02 m/sec* whichever is greater * Accuracy specification only valid for velocity readings above 50 fpm or 0.25 m/sec.
CO ₂	0 to 5000 ppm	1 ppm	Warm up time 1 min (5 minutes for full specification) 2.75 % + 75 ppm
CO	0 – 500 ppm	1 ppm	±5 % or ±3 ppm, whichever is greater, @ 20 °C and 50 %RH Additional de-rating over Temperature: ±0.6 %/°C from calibration temperature ±0.6 %/°C < 20 °C Long term drift < 2 % per month. Maximum shift in arid or humid storage conditions*: ±0.6 % per day (Reference storage test conditions: 50 °C, 15 % RH and 30 °C, 95 % RH)
<p>*After the CO calibration seal is removed and the Meter is stored for an extended period in arid or humid conditions, verify that the sensor is within specification by applying a known concentration of gas using the calibration procedures listed under Calibration.</p>			

Calculated Parameters

Calculated Parameters	Range	Display Resolution	Accuracy
Dew Point Temperature	-44 to 50 °C -47 to 122 °F	0.1 °C 0.1 °F	<p>±1 °C When Temp: -20 °C to 50 °C RH: 40 % to 90 %</p> <p>± 2 °C When Temp: -20 °C to 50 °C RH: 20 % to 40 %</p> <p>± 4 °C When RH: 10 % to 20 %</p>
Wet Bulb Temperature	-16 to 50 °C 3 to 122 °F	0.1 °C 0.1 °F	<p>±1.2 °C when : RH: 20 % to 90 % Temp: -20 °C to 50 °C</p> <p>± 2.1 °C when : RH: 10 % to 20 %</p>
Volume Flow Rate (in a duct)		1 cfm 0.01 M ³ /hr	N/A The volume flow calculation will be a simple average of the data points times the duct area
% outside air (Based on Temperature)	0 to 100 %	0.1 %	N/A
% Outside Air (Based on CO ₂)	0 to 100 %	0.1 %	N/A
Minimum, Maximum and Average on all measured parameters	Per measured parameter spec	Per measured parameter spec	Per measured parameter spec

Environmental Specifications

Operating and Storage Temperature:	-20 to 50 °C (-4 to 122 °F)
Humidity:	10 to 90 % non-condensing
Altitude:	Up to 2000 m (6562 ft)
Vibration:	Per MIL-PRF-28800F: Class 2

Physical Specifications

Meter size:	28.70 cm x 11.43 cm x 5.08 cm (11.3 in x 4.5 in x 2 in)
Meter weight:	0.544 kg (1.2 lb)
Hard-shell case size:	11.93 cm x 35.65 cm x 43.18 cm (4.7 in x 14 in x 17 in)
Velocity probe size:	28.70 cm, 99.06 cm extended x 2.54 cm (11.3 in, 39 in extended x 1 in)
Velocity probe weight:	198 g (7 oz)
Impact resistance:	1 m drop test (3.28 ft drop test)
Power supply:	Rechargeable Lithium battery or Universal AC power adapter with plug adapters for USA, Great Britain, Europe, and Australia
Backup power supply:	3 AA (IEC LR06) batteries used as backup power
Battery life:	Rechargeable Lithium battery - 11 hours (at room temperature)* Backup AA batteries - 7 hours

**Note*

Lithium batteries can greatly extend the operating life of the meter if cared for properly. To ensure optimum capacity do not store for extended periods of time above 35 °C (95 °F).

Agency Approvals, Certifications and Standards Compliance

The Meter complies with the following standards and meets requirements for the following certifications:

EMC: EN61326-1.

AS/NSZ CISPR 11

Safety: EN61010:2001



N10140



Replaceable Parts and Accessories

To order parts and accessories for the Meter, refer to Figure 6 and Table 6.

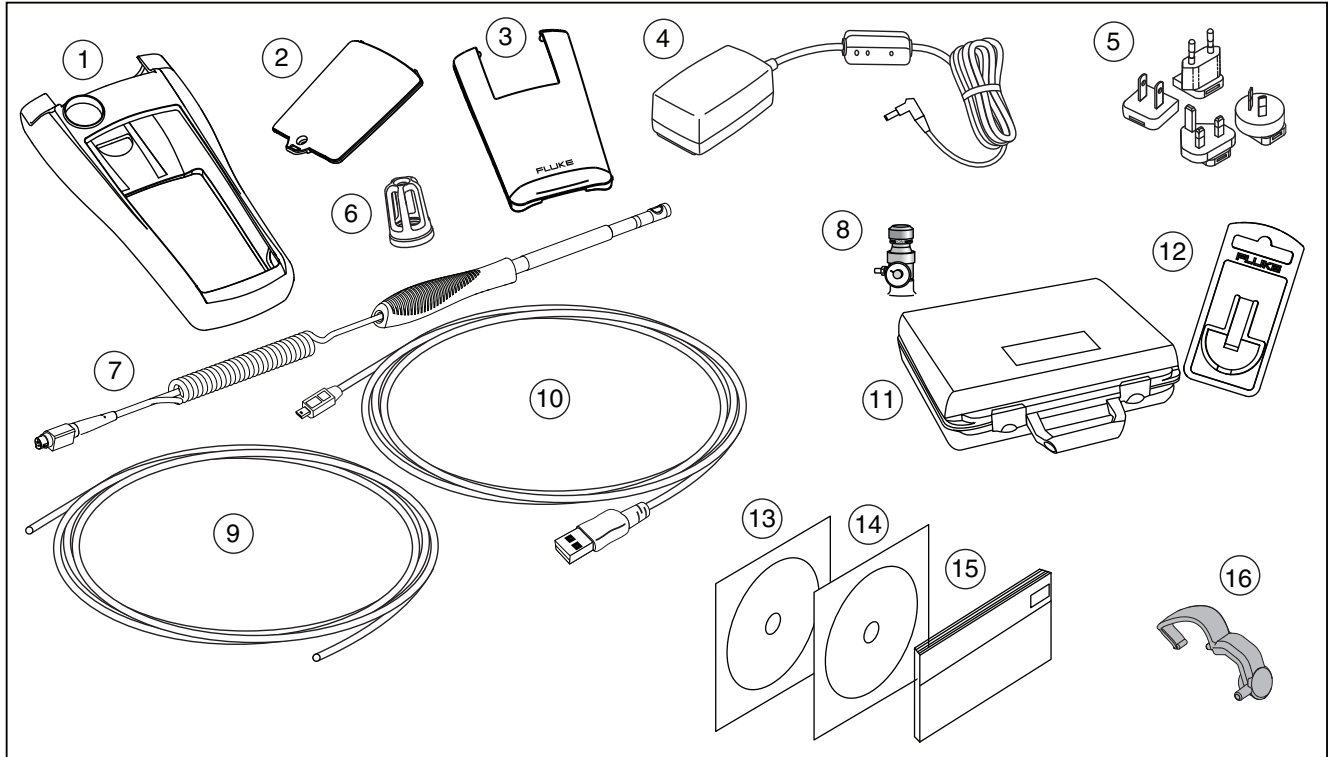

Figure 6. Replaceable Parts and Accessories

eba10f.eps

Table 6. Replaceable Parts and Accessories

Item Number	Part Number or Model Number	Description
①	2514351	Holster
②	2514336	Battery Door
③	2514349	Tilt Stand
④	2664162	AC Power Adapter
⑤	2664357	International Adapter Blade Kit containing type A, C, G, and I adapters to fit most countries
⑥	2526937	Cap, Temperature/Humidity Probe
⑦	Air Velocity Probe	Air Velocity Probe (optional)
⑧	2770767	Calibration-flow regulator valve
⑨	2679599	Calibration tubing, Plastic 2 ft x ¼ inch
⑩	2665668	USB Cable
⑪	2679501	Hard Shell Carrying Case
⑫	TPAK80-4	ToolPak accessory kit (optional)
⑬	1578384	FlukeView® Forms Documenting Software
⑭	2507224	975 Manuals CD containing the Users Manuals in English, French, German, Portuguese, Spanish, and Simplified Chinese
⑮	2507213	Users Manual (printed English)
⑯	2694684	Calibration Cap