

SECTION A-A

TOP VIEW

1

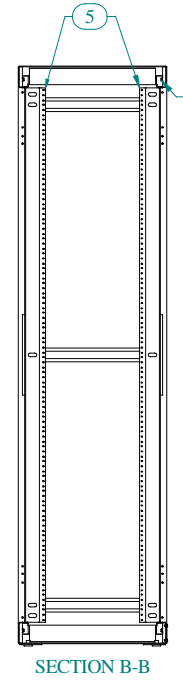
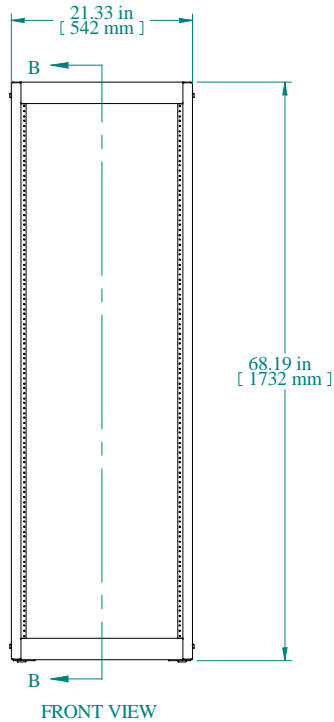
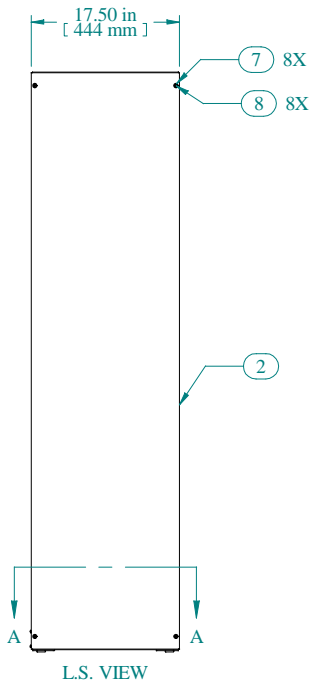
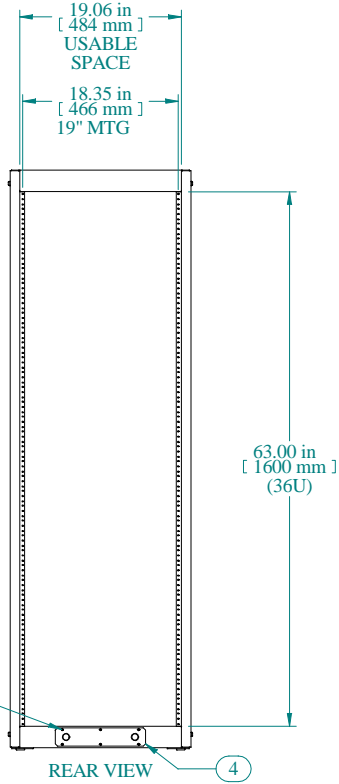

SECTION B-B



Item Number	Title	Quantity
1	REFK - TOP PANEL	1
2	REFK - SIDE PANEL	2
3	REFK - BOTTOM PANEL	1
4	REFK - GLAND PLATE	1
5	COMBINATION RAILS TAPPED (PAIR)	2
6	SCREW 6-32X1/4 SELF TAPPING	6
7	FLAT NYLON WASHER 1/4" I.D.	8
8	SCREW 1/4-20 X 1/2	8
9	NUT 1/4-20 KEP	8

PART NUMBERS		
REFK1906317BK1	PAINTED BLACK TEXTURED	
REFK1906317CG1	PAINTED CONT. GRAY TEXTURED	
REFK1906317LG1	PAINTED RAL7035 TEXTURED	
NOTES		
Shipped knockdown for handling ease & protection.		

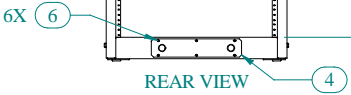

L.S. VIEW

FRONT VIEW

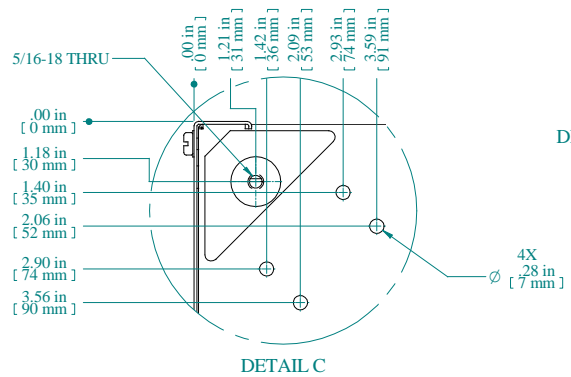

DETAIL C

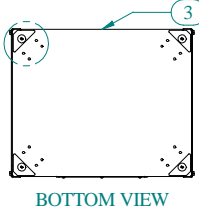

BOTTOM VIEW

Data subject to change without notice. Isometric drawing not to scale.

**HAMMOND
MANUFACTURING™**

www.hammondmfg.com

PART NO. REFK1906317