



VICOR PRODUCT CATALOG

BRICKS



V-I CHIP



PICOR



CONFIGURABLE PSUs



MIL-COTS



CUSTOM



VICOR CORPORATION

Power Solutions

Vicor's product line of modular power components and complete power systems includes thousands of combinations of input voltage, output voltage, and power levels, complete with accessory components that integrate other power system functions. Together, these products allow designers around the world to meet their unique power requirements by selecting and interconnecting standard modular parts. The benefits for you are rapid, flexible design of complete power systems at any power level.

If you don't find the converter you need from our thousands of predefined DC-DC converters, you can design your own custom product on the web using Vicor's PowerBench Design System. We offer a wide range of solutions with 1 – 20 outputs and autoranging, PFC, or three-phase inputs. There are several chassis sizes to choose from, both with and without integral cooling fans. Also available from Vicor is a strong offering of front ends and filters to complete your design. Our extensive MIL-COTS product line incorporates the technology and features of our commercial products into a cost-effective alternative for military, aerospace, and other high-reliability, harsh-environment applications. Standard inputs of 28, 48, 155, 270, and 375 Vdc are available.

Vicor is pioneering the second wave of the power component revolution with the introduction of flexible, high-performance power components. V•I Chip™ Factorized Power Architecture provides the means to more efficient power distribution and the V•I Chips provide the building blocks with the right attributes of high density and efficiency, flexibility, and fast transient response that enable power architects to more easily design small, high-performance, cost-effective power system solutions. V•I Chip PRMs™ (regulators), VTMs™ (voltage transformers) and BCMs™ (bus converters) are available for a wide range of DC-DC conversion and Intermediate Bus Architecture applications. MIL-COTS versions are also available.

New power options are available with Picor's first standard semiconductor solution – Cool-ORing™ – that can substantially reduce power dissipation and size, while providing superior dynamic response for Active ORing applications in redundant power architectures. Another new option is the new modular power platform: VI BRICK. The new VI BRICK family is an advanced modular power platform that incorporates the superior technical attributes of V•I Chip technology and a robust packaging that facilitates thermal management and through-hole assembly. Models include high-current density / low-voltage DC-DC converters, a wide range of highly efficient bus converters (BCM), and individual modules – PRM and VTM – for both regulation and transformation.

Vicor Custom Power provides complete power solutions for communications, industrial, datacom, test equipment, medical diagnostics, and MIL-COTS. Using the extensive Vicor line of DC-DC converters in a modular, building-block design approach, Custom Power offers total solutions to unique power requirements in the shortest possible time.

All our products deliver agency-approved reliability and the predictable performance of field-proven power technology, including conformance to RoHS if desired. Vicor is ISO 9001:2000 certified and places heavy emphasis on the "Plan-Do-Check-Act" model (PDCA) to foster continuous improvement. This enables proactive actions to be undertaken to improve our technology, our products, our processes, and our service to our customers. Our new [Quality Center on vicorpower.com](http://www.vicorpower.com) enables quality managers, purchasing agents, and designers to see comprehensive video of our facilities as well as generate customized ISO 9001:2000 reports about our quality systems.

Be assured that Vicor is on a continuous quest for the best technical solution for you. Moreover, our commitment to the elegance and affordability of your design is backed up by our global staff of experienced applications engineers. Rely on Vicor as your dedicated design partner.



PICOR

V•I Chips

VI BRICKs

Bricks

Westcor Configurables

Custom

TABLE OF CONTENTS

Product Overview Chart.....	2 – 3
DC-DC V-I Chip™ Advantage	4
<i>Power Conversions Using PRM, VTM & BCMs</i>	4
<i>Bus Converter (BCM™)</i>	5
<i>Regulator (PRM™)</i>	6
<i>Voltage Transformer (VTM™)</i>	7
VI BRICKS	8
<i>PRM, VTM, BCM & DC-DC Converter</i>	8 – 11
DC-DC BRICKS	12
<i>VI-200 & VI-100 Series Converter Modules</i>	12 – 13
<i>Maxi, Mini & Micro Series Converter Modules</i>	14 – 15
Power Path Management Solutions	16
<i>Cool-ORing™ Series</i>	16 – 17
AC-DC Front Ends	18
<i>Harmonic Attenuator Module (HAM)</i>	18
<i>AC-DC / DC-DC PFC FrontEnd</i>	19
<i>Alternating Input Module (AIM)</i>	20
<i>Autoranging Rectifier Module (ARM)</i>	21
<i>Filter / Autoranging Rectifier Module (FARM)</i>	21
<i>Modular AC Front-end System (ENMods)</i>	22
Brick	23
<i>BatMod Battery Charger</i>	23
<i>Packaging Options</i>	23
Filters	24
<i>Filter Input Attenuator Module (FIAM)</i>	24
<i>Input Attenuator Module (IAM)</i>	24
<i>Ripple Attenuator Module (RAM)</i>	25
<i>Output Ripple Attenuator Module (MicroRAM)</i>	25
<i>Active EMI Filters (QPI Family)</i>	26
<i>Output Ripple Attenuators (QPO Family)</i>	27
AC-DC / DC-DC Configurable Power Solutions	28
<i>AC-DC FlatPAC Family</i>	28
<i>AC-DC PFC FlatPAC</i>	29
<i>AC-DC VIPAC Power System</i>	30
<i>DC-DC VIPAC Arrays</i>	31
<i>DC-DC ComPAC Family</i>	32
<i>DC-DC MegaMod Family</i>	33
MIL-COTS Products	34 – 37
Westcor Configurable Power Solutions	38
<i>AC-DC / DC-DC LoPAC Family</i>	38
<i>AC-DC / DC-DC FlatPAC-EN</i>	39
<i>AC-DC / DC-DC MegaPAC Family</i>	40
<i>DC-DC (only) ConverterPACs</i>	41
Custom Power Solutions	42 – 43
Custom Configurable Power Solutions	44 - 45
<i>DC-DC MegaPAC</i>	44
<i>VME450 DC-DC Power Supply</i>	44
<i>Badger AC-DC Power Supply</i>	45
<i>Javelin AC-DC Power Supply</i>	45
<i>PowerBank AC-DC Power Supply</i>	45
Evaluation Boards	46 – 47
Accessories	48 – 52
Quality / RoHS Compliance	53
Vicorpower.com Technical	54
PowerBench Tools	55
Applications Support	56
Customer Support	57

WHAT'S NEW

Vicor develops new products all the time, so, to keep everyone up-to-date, we've created a special area on vicorpower.com where you can always see "what's new." Just go to vicorpower.com and click on "What's New." It will take you to our new products page. From there you'll be able to link to detailed design information.

Web ExpressCode

Web ExpressCode provides quick access to detailed product information

Each product description in the Vicor catalog includes a unique Web ExpressCode. Each code provides direct access to the corresponding, information rich product pages on vicorpower.com. Just enter the Web ExpressCode into the Web ExpressCode search box on vicorpower.com's homepage. You'll be sent to the exact page you want with access to all related information such as product description, operating specifications, access to data sheets, outline drawings, and product configuration tools.



PowerBench™ You Design It ,We Build It

PowerBench is the most advanced suite of online power tools available. They can help you design, select and configure products whether you are just beginning or experienced in designing power, PowerBench can take you from beginning to end of any power project. All of this in real time.

See for yourself what Vicor can do for you on [Page 55](#) or go to the Vicor website, click PowerBench and start building.



OVERVIEW

V-I Chip & VI BRICK Solutions

DC-DC Products

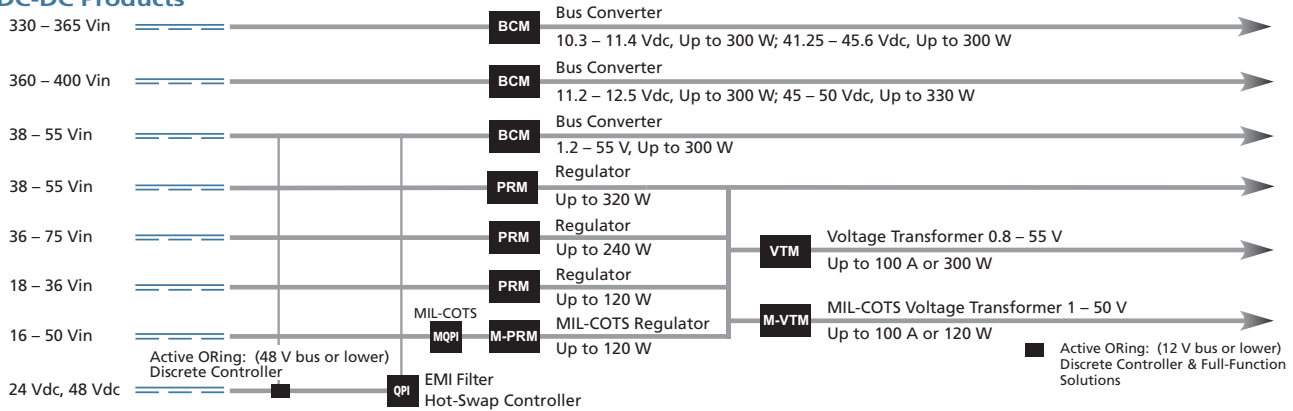

Component Power Solutions: VI-200 & VI-J00 Series

AC-DC Products

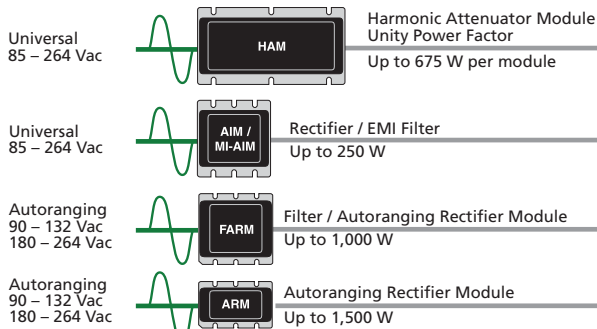

DC-DC Products

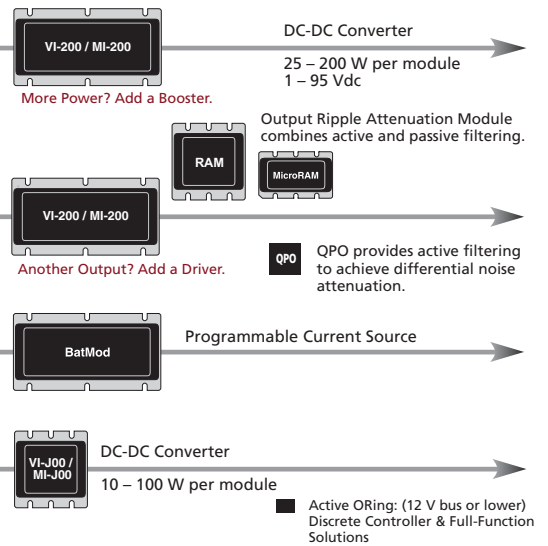

DC-DC Products

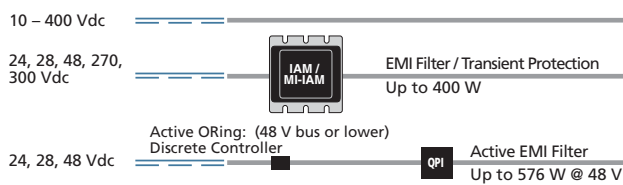

Component Power Solutions: Maxi, Mini, Micro & VI BRICK Series

AC-DC Products

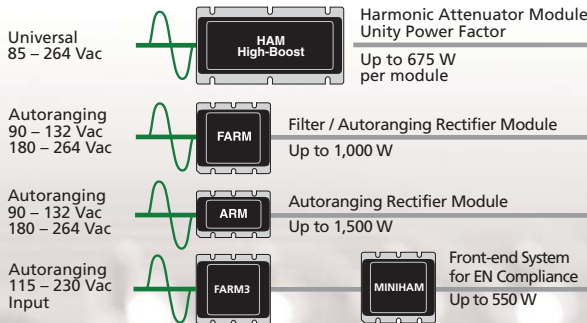

DC-DC Products

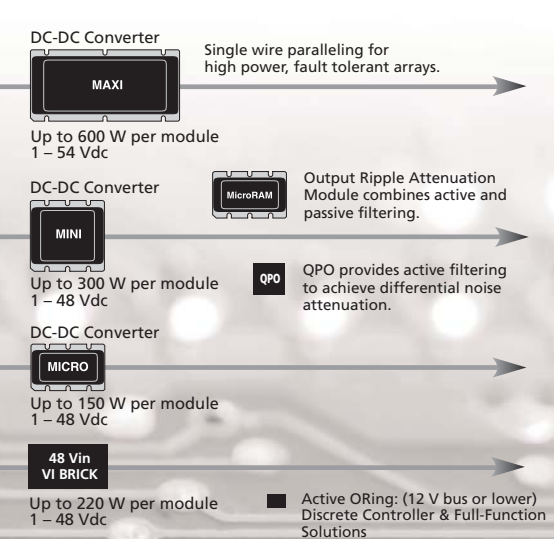

DC-DC Products

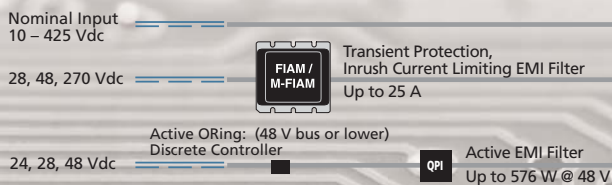

OVERVIEW

Configurable Power Solutions

VIPAC Power Systems

90 – 132 Vac
180 – 264 Vac

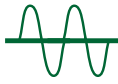

1 – 3 Outputs using
Maxi, Mini & Micro
Series Modules



LoPAC Family

85 – 264 Vac
100 – 380 Vdc

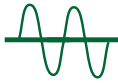

1 – 6 Outputs using
VI-200, VI-J00 Series or
Maxi, Mini & Micro
Series Modules

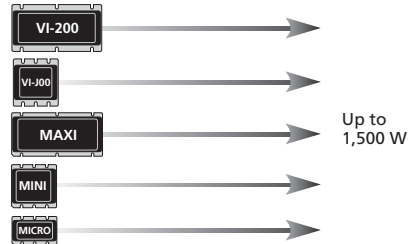

FlatPAC Family

90 – 132 Vac
180 – 264 Vac
85 – 264 Vac (PFC)



1 – 3 Outputs using
VI-200 / Maxi
Series Modules

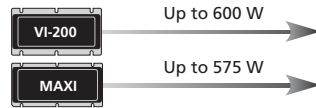

PFC FrontEnd

85 – 264 Vac
100 – 380 Vdc



1 – 4 Outputs using
VI-200, VI-J00 Series or
Maxi, Mini & Micro
Series Modules

Can also be used
with VIPAC Array,
V-I Chip BCM,
and more

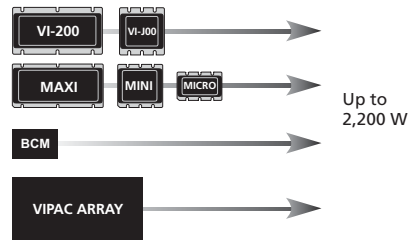

FlatPAC-EN

90 – 132 Vac
180 – 264 Vac
250 – 380 Vdc

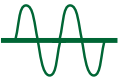

1 – 4 Outputs using
VI-200, VI-J00 Series or
Maxi, Mini & Micro
Series Modules

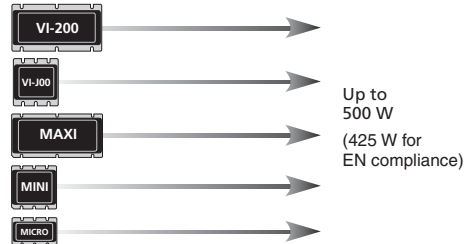

MegaPAC Family

85 – 264 Vac
3ø 208/240 Vac
100 – 380 Vdc



1 – 20 Outputs using
VI-200, VI-J00 & Maxi
Series Modules



VIPAC Arrays

DC Inputs
24, 28, 48, 72, 110,
150, 300, 375 Vdc



1 – 4 Outputs using
Maxi, Mini & Micro
Series Modules

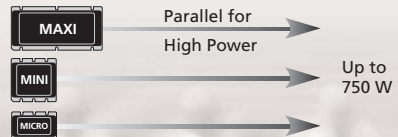

MegaMod Family (Chassis Mount)

DC Inputs
10 – 400 Vdc



1 – 3 Outputs using
VI-200 / MI-200 or
VI-J00 / MI-J00
Series Modules

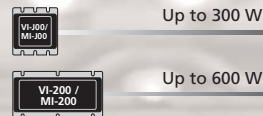

CompAC Family

DC Inputs
24, 28, 48, 270,
300 Vdc

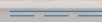

1 – 3 Outputs using
VI-200 / MI-200
Series Modules



Front-end filtering optimized for communication and defense applications

U.S. & CANADA: 800-735-6200 VICORPOWER.COM

3

Consult back cover for a complete list of contacts.

V·I CHIP SOLUTIONS



48 V BCM™ Bus Converter



page 5

- ZVS / ZCS isolated Sine Amplitude Converter
- Input: 38 – 55 Vdc
- Output: Eleven models, 1.5 to 48 V
- Power: Up to 300 W (450 W for 1 ms)
- Efficiency: Up to 96.5%
- High density: Up to 1,036 W/in³ (68 W/cm³)
- Small footprint: 1.1 in² (7.1 cm²)
- 125°C operation (Tj)
- Low weight: 0.5 oz (15 g)
- >3.5 million hours MTBF
- Low noise: No output filtering required
- J-Lead package pick & place / SMD compatible
- Through-hole pin option, full size

48 V PRM™ Regulator



page 6

- 48 Vin ZVS buck / boost regulator
- Input: 36 – 75 Vdc or 38 – 55 Vdc
- Provides 26 – 55 Vdc output factorized bus for 48 Vin VTMs
- Efficiency: Up to 97%
- High density: Up to 1,105 W/in³ (55 W/cm³)
- Small footprint: 1.1 in² (7.1 cm²)
- 125°C operation (Tj)
- Low weight: 0.5 oz (15 g)
- J-Lead package pick & place / SMD compatible
- Through-hole pin option

VTM™ Voltage Transformer



page 7

- 48 Vin Sine Amplitude Converter
- 26 – 55 Vdc input range
- 0.8 – 55 Vdc outputs
- Efficiency: Up to 97%
- High density: Up to 345 A/in³
- Up to 100 A or 300 W
- Small footprint: Up to 90 A/in²
- 125°C operation (Tj)
- Low weight: 0.5 oz (15 g)
- Isolation to 2,250 Vdc
- <1 μs transient response
- Low noise: No output filtering required
- J-Lead package pick & place / SMD compatible
- Through-hole pin option

[MIL-COTS Version Available](#)

[Page 34](#)

High Voltage BCM Bus Converter



page 5

- ZVS / ZCS isolated Sine Amplitude Converter
- 330 – 365 Vdc to 11 Vdc @ 300 W
- 360 – 400 Vdc to 12 Vdc @ 300 W
- Efficiency: Up to 97%
- High density: Up to 1,034 W/in³
- Small footprint: 1.1 in² (7.1 cm²)
- 125°C operation (Tj)
- Isolation to 4,242 Vdc
- >2.6 million hours MTBF
- Low noise: No output filtering required
- Low weight: 0.5 oz (15 g)
- J-Lead package pick & place / SMD compatible
- Through-hole pin option

24 V PRM Regulator



page 6

- 24 Vin ZVS buck / boost regulator
- Input: 18 – 36 Vdc
- Provides 26 – 55 Vdc output factorized bus for 48 Vin VTMs
- Efficiency: Up to 95%
- High density: Up to 414 W/in³ (25 W/cm³)
- Small footprint: 1.1 in² (7.1 cm²)
- 125°C operation (Tj)
- Low weight: 0.5 oz (15 g)
- J-Lead package pick & place / SMD compatible
- Through-hole pin option

[MIL-COTS Version Available](#)

[Page 34](#)

QPI for V·I Chips Input Filter Module



page 26

- Support EN55022, Class B limits
- Compatible with 48 and 24 V V·I Chips
- Efficiency: >99%
- Up to 65 dB CM attenuation at 1 MHz
- Up to 80 dB DM attenuation at 1 MHz
- 7 A models, parallelable for up to 14 A
- Hot-Swap models available
- Supports AdvancedTCA® PICMG3.0 requirements
- 12,5 x 25 x 4,5 mm LGA package
- 25 x 25 x 4,5 mm package for Hot-Swap models

VI BRICK

Thermally enhanced packaging option available for PRM, VTM, BCM, [Page 8 – 10](#)



Evaluation Boards Available

[Page 46](#)



BRICK SOLUTIONS



VI-200 / VI-J00 DC-DC Converter



page 12-13

MIL-COTS Version Available
Page 35

- Input voltage ranges: 10 – 400 Vdc
- Output voltages: 1 – 95 Vdc
- Output power (per module):
VI-200: 50 – 200 W • VI-J00: 25 – 100 W
- Parallelable for higher power
- 100°C operation: 85°C for VI-200
- Efficiency: Up to 90%
- Agency approvals: CE Marked
cULus, cTUVus

Maxi / Mini / Micro DC-DC Converter

MIL-COTS Version Available

Page 35



page 14-15

- Input voltages: 24, 28, 48, 72, 110, 150, 300, 375 Vdc
- Output power: 50 – 600 W
- 100°C, no derating
- High efficiency
- Low-noise ZCS / ZVS
- High power density: Up to 120 W/in³

VI BRICK PRM / VTM / BCM



page 8-10

MIL-COTS Version Available
Page 34

- Brick solution for Factorized Power
- Thermally enhanced package – baseplate and through-hole pin
- 100°C baseplate operation
- Small footprint: 2.08 in²
- Low profile: 0.37 inches above board
- Efficiency: Up to 97%
- High power density: Up to 390 W/in³

VI BRICK DC-DC Converter



page 11

- Input range: 36 – 75 Vdc
- Efficiency: Up to 93%
- Output voltages: 1 – 48 V
- Fast dynamic response
- Low noise
- Maximum case temperature: 100°C, no derating

QPI Family Active EMI Input Filters



page 26

QuietPower™

- Up to 60 dB CM attenuation at 250 kHz
- Up to 80 dB DM attenuation at 250 kHz
- Up to 14 A
- Efficiency: >99% at full load
- High density, low profile LGA package
- Designed to support EN Class B
- Integrated Hot-Swap in select models
- Current rating supports ATCA® blades
- 40°C to +100°C PCB temperature
- Compatible with most industry standard DC-DC converters

QPO Family Active Output Ripple Attenuators



page 27

QuietPower™

- >30 dB PARD attenuation, 1 kHz to 500 kHz
- 3 – 30 Vdc and 0.3 – 5.5 Vdc input models
- Up to 20 A
- Supports precise point-of-load regulation
- Reduces required number of output capacitors to support dynamic loads
- Selectable optimization of attenuation, power dissipation, transient load response
- Compatible with most industry standard DC-DC converters

Front-end Modules



page 18-22

MIL-COTS Version Available
Page 35

- Up to 1,000 W power output
- 85 – 264 Vac input
- Efficiency: 90 – 98%
- Agency approvals: CE Marked, cTUVus, cULus
- Operating temperature: –55°C to +100°C
- Inrush current limiting

Input Filter Modules



page 24

MIL-COTS Version Available
Page 36

- 24, 48 and 300 V models
- Efficiency: Up to 98%
- Agency approvals: CE Marked, cTUVus, cULus
- Operating temperature: –55°C to +100°C
- Designed to meet EN Class B, Bellcore and FCC transient and immunity

Output Filter Modules



page 25

MIL-COTS Version Available
Page 36

- 5 – 50 V, Up to 20 A
- 3 – 30 V, Up to 30 A
- Efficiency: Up to 98%
- Up to 40 dB attenuation from 60 Hz to 1 MHz
- Operating temperature: –55°C to +100°C

PICOR SOLUTIONS



Cool-ORing™ Series Controllers



page 16

- Fast dynamic response
- 4 A gate discharge current
- Accurate MOSFET voltage sensing
- Overtemperature fault detection
- Adjustable reverse current blanking timer
- Withstands 100 V transients in low-side applications
- Master / Slave I/O for paralleling
- Active low-fault flag output
- Compatible with bricks and V•I Chips

Cool-ORing™ Series Full-Function Solutions



page 17

- Combines a high-speed ORing MOSFET controller and a very low on-state resistance ORing MOSFET
- Integrated high-performance MOSFET
 - PI2121: 8 V, 24 A, 1.5 mΩ
 - PI2122: 7 V, 12 A, 6 mΩ (back-to-back MOSFET)
 - PI2123: 15 V, 15 A, 3 mΩ
 - PI2125: 30 V, 12 A, 5.5 mΩ
- Very small, high density optimized solution
- Fast dynamic response
- Accurate sensing capability
- Compatible with bricks and V•I Chips

CONFIGURABLE POWER SUPPLIES



VIPAC AC-DC or DC-DC Power Solution



page 30

- Input voltage ranges: 115/230 Vac, 28 Vdc (MIL-COTS)
- Output voltages: 2 – 48 Vdc
- Output power: Up to 900 W
- Single, dual, or triple outputs
- Efficiency: 80 – 90%
- Local or remote control

VIPAC Arrays DC Input Power System



page 31

[MIL-COTS Version Available](#)
Page 37

- Input voltages: 24, 300, Vdc
- Output voltages: 2 – 54 Vdc
- Output power: 50 – 650 W
- Array power: Up to 750 W
- Single, dual, triple or quad outputs
- Rugged, low profile, coldplate chassis
- High-temperature capability

FlatPAC AC-DC Power Solution



page 28

- Input voltage: 115/230 Vac input, autoranging
- Output voltages: 1 – 95 Vdc
- Output power: 50 – 600 W
- Single, dual, or triple outputs
- Low-noise ZCS / ZVS power technology
- Agency approvals: CE Marked, cTÜVus, cULus

ComPAC Input Power Solution



page 32

[MIL-COTS Version Available](#)
Page 37

- Input voltages: 24, 48 and 300 Vdc
- Output voltages: 1 – 95 Vdc
- Efficiency: 80 – 90%
- Power density: Up to 10 W/in³
- Low-noise FM control
- ZCS / ZVS power architecture

MegaMod Chassis-mount Converter



page 33

[MIL-COTS Version Available](#)
Page 37

- Input voltage range: 10 – 400 Vdc
- Output voltages: 1 – 95 Vdc
- Output power: Up to 600 W
- Single, dual, or triple outputs
- Efficiency: 80 – 90%
- Low-noise ZCS power architecture

PFC FrontEnd 384 Vdc Output Front End



page 19

- Input voltage ranges: 85 – 264 Vac and 100 – 380 Vdc
- Output power: Up to 2,200 W
- Up to 4 non-isolated outputs
- Operating temperature: –20°C to +45°C (full power)
- DIN rail mountable

CONFIGURABLE POWER SUPPLIES



PFC FlatPAC Single-Output Power System



page 29

- Input voltage range: 85 – 264 Vac
- Output power: Up to 575 W
2 – 54 Vdc
- High efficiency
- Current limit
- Remote sense

LoPAC Family Switcher Power Supplies



page 38

- Input voltage ranges: 85 – 264 Vac and 100 – 380 Vdc
- Output voltages: 2 – 95 Vdc (higher voltage available with series arrays)
- Output power: 25 – 1,500 W
- Up to 6 user-specifiable outputs
- Power density: Up to 11 W/in³

MegaPAC Family User-Configured



page 40

- Input voltage ranges: 85 – 264 Vac and 100 – 380 Vdc
- Output voltage: 2 – 95 Vdc (higher voltage available with series arrays)
- Output power: 25 – 4,000 W
- Up to 20 outputs
- High power density

FlatPAC-EN AC-DC Power Solution



page 39

- Input voltage ranges: 90 – 132 / 180 – 264 Vac
250 – 380 Vdc
- Output voltages: 2 – 95 Vdc
- Output power: Up to 500 W
- Up to 4 user-specifiable outputs

DC MegaPAC™ Power Switcher



page 45

- Input voltage range: 12 – 72 Vdc
- Output voltages: 2 – 95 Vdc
- Output power: Up to 1,600 W
- Up to 16 outputs

VME450™ Single-slot Power Supply



page 45

- Vin max range: 18 – 36 Vdc
- Input power: 650 W
- Output power: 550 W
- Temperature: –40 to +85°C
- Low profile: 0.670 in. max. height
- Utilizes Vicor's V•I Chips

Javelin™ MIL-COTS Power Supply



page 44

- Input voltage ranges: 85 – 254 Vac (PFC) / 85 – 380 Vdc
- Output voltages: Single output 2, 3.3, 5, 12, 15, 24, 28, 48 Vdc
- Output power: 600 – 5,400 W

PowerBank™ Low Profile Supply



page 44

- Input voltage: 115/230 Vac
- Output voltages: 1.8 – 52 V
- Output power: 1000 W @ 230 Vac input, 800 W @ 115 Vac input
- Operating temperature: –20°C to +50°C

Badger™ MIL-COTS Power Supply



page 44

- Input voltage ranges: 85 – 264 Vac and 100 – 380 Vdc
- Output power: Up to 1,800 W
- Up to 12 non-isolated outputs
- Operating temperature: –55°C to +65°C

CUSTOM SOLUTIONS

Don't see what you need...

Vicor Custom Power can design and manufacture a power supply built to your unique specifications. We specialize in turnkey custom power systems for electronic equipment manufacturers in the datacom, telecom, industrial, test equipment, medical, information technology, and MIL-COTS markets.

Utilizing Vicor component power modules in a building-block design approach offers low cost, quick turnaround, and reliable performance.

For more information on custom solutions, see [pages 42 – 43](#).



The V•I Chip™ Advantage Density, Efficiency, Flexibility, & Speed

RoHS

Vicor's V•I Chips, new families of integrated power components, give the power architect new ways to create small, cost-effective, high-performance power system solutions.

V•I Chips increase power system flexibility by separating or factorizing a DC-DC converter into two components. One component provides a regulation function (PRM™), and another provides transformation and isolation (VTM™ / BCM™). This allows the power system designer to select only the functions that are needed, where they are needed.



Shown at actual size.

Regulation

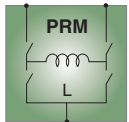

Regulator

Transformation & Isolation

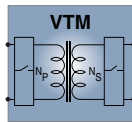

Voltage Transformer

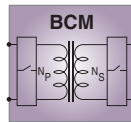

Bus Converter

VI BRICKS

PRM, VTM, BCM models available
Baseplate with through-hole pins
[Page 8 – 10](#)

DC-DC Conversion Using PRM & VTM

System solution with low component count

- VTM isolation and transformation at the point of load
- PRM regulation can be collocated with or remote from the VTM
- Efficiency: Up to 93%
- High power density: Up to 517 W/in³

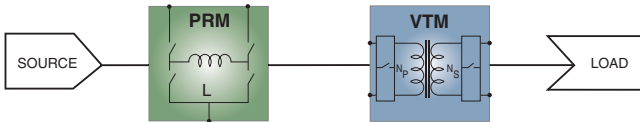

Bus Conversion Using BCMs

Enable dense IBA Power Systems

- High density bus converter > 1,000 W/in³
- Efficiency: Up to 96.5%
- Minimize total system capacitance

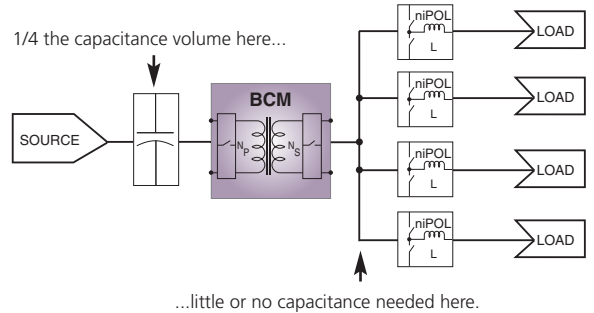

High Current Low Voltage Supply

- Enable twice the current in half the space
- Up to 295 W or 200 A

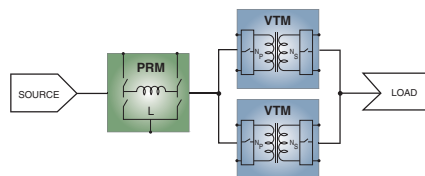

High Voltage Outputs

- Put VTM stages in series to achieve output voltages greater than 55 V

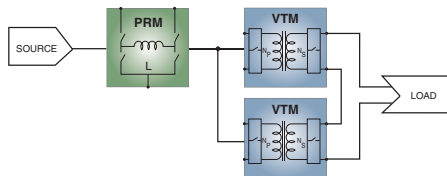

High Power Arrays

- Parallel PRMs and VTMs to create multi-kW power systems

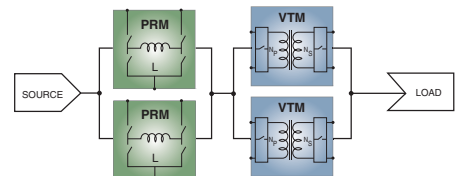

DC-DC V•I Chip

Web ExpressCode: **bcm**

BCM™ Bus Converter Module

RoHS

The BCM is a member of the new family of V•I Chips. It provides an isolated intermediate bus voltage to power non-isolated POL converters from a narrow range DC input, or it can be used as an independent DC source. The BCM offers superior performance and lower cost than conventional bus converters. BCMs are available in standard 48 V telecom as well as in high-voltage offline input ranges. Due to the fast response time and low noise of the BCM, the need for limited life aluminum electrolytic or tantalum capacitors at the load is reduced – or eliminated – resulting in savings of board area, materials, and total system cost.

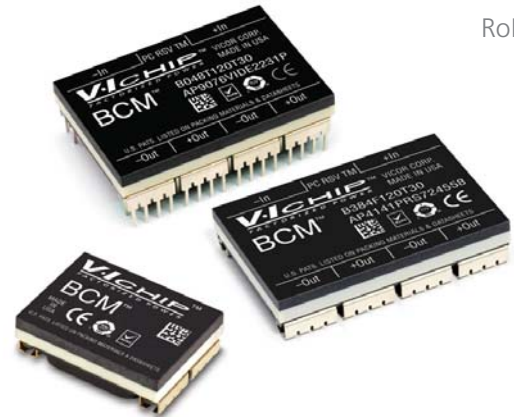

Features

- Fixed-ratio bus converter
- Available in 48, 352, and 384 V inputs
- High density: Up to 1,100 W/in³
- Isolation to 4,242 Vdc
- Efficiency: Up to 96.5%
- Output power: Up to 330 W
- Small footprint: 1.1in² (7.1 cm²)
- Pick & place / SMD compatible
- Through-hole pin option
- 125°C operation (Tj)
- >3.5 million hours MTBF

VI BRICK

BCM model Page 10

Heat Sinks Available

Page 48

MIL-COTS Version Available

Page 34

Part Numbering

For a complete listing of our BCM model numbers, go to vicorpower.com/vichip

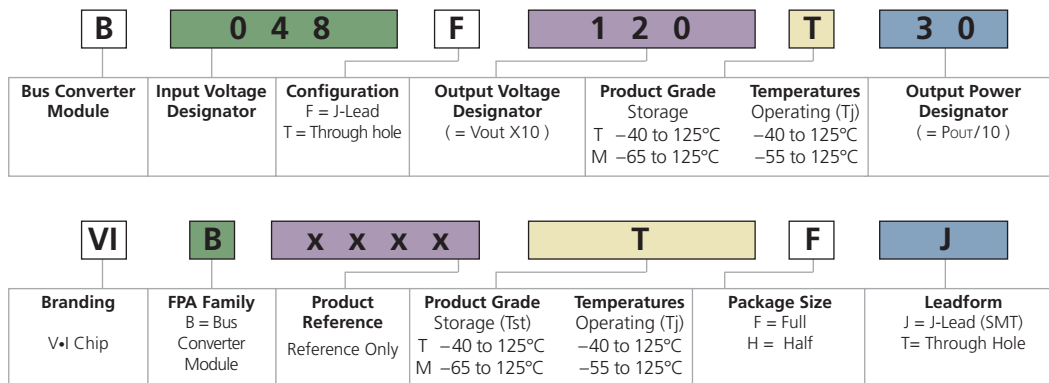

Input Voltage	K Factor	Vout		Max Power	Pack Size	BCM Model No.
		@ 48 Vin	Range			
38 – 55 Vdc	1/32	1.5 Vdc	1.19 – 1.71 Vdc	135 W	Full	B048F015T14
	1/16	3.0 Vdc	2.38 – 3.43 Vdc	210 W	Full	B048F030T21
	1/12	4.0 Vdc	3.17 – 4.58 Vdc	200 W	Full	B048F040T20
	1/8	6.0 Vdc	4.75 – 6.87 Vdc	240 W	Full	B048F060T24
	1/6	8.0 Vdc	6.34 – 9.16 Vdc	240 W	Full	B048F080T24
	1/5	9.6 Vdc	7.60 – 11.00 Vdc	240 W	Full	B048F096T24
	1/4	12.0 Vdc	9.50 – 13.75 Vdc	120 W	Half	VIB0101THJ
	1/4	12.0 Vdc	9.50 – 13.80 Vdc	300 W	Full	B048F120T30
	1/3	16.0 Vdc	12.70 – 18.30 Vdc	240 W	Full	B048F160T24
	1/2	24.0 Vdc	19.00 – 26.50 Vdc ^[b]	300 W	Full	B048F240T30
	2/3	32.0 Vdc	25.30 – 36.70 Vdc	300 W	Full	B048F320T30
1	48.0 Vdc	38.00 – 55.00 Vdc	300 W	Full	B048F480T30	

^[b] Vin = 38 – 53 Vdc

Input Voltage	K Factor	Vout		Max Power	Pack Size	BCM Model No.
		@ Nom. Vin	Range			
360 – 400 Vdc	1/32	12.0 Vdc	11.30 – 12.50 Vdc	300 W	Full	B384F120T30
330 – 365 Vdc	1/32	11.0 Vdc	10.30 – 11.40 Vdc	300 W	Full	VIB0001TFJ
360 – 400 Vdc	1/8	48.0 Vdc	45.00 – 50.00 Vdc	325 W	Full	VIB0002TFJ
330 – 365 Vdc	1/8	44.0 Vdc	41.25 – 45.63 Vdc	325 W	Full	VIB0003TFJ

DC-DC V-I Chip

PRM™ Regulator

Web ExpressCode: [prm](#)

RoHS

The PRM is a high-efficiency, non-isolated regulator capable of both boosting and bucking a wide-range input voltage. PRMs may be used independently, as stand-alone regulators, or together with downstream V-I Chip VTMs™ — fast, efficient, isolated low-noise point-of-load (POL) converters.

PRMs feature unique "Adaptive Loop" compensation feedback: a single-wire alternative to traditional remote sensing and feedback loops that enables precise control of an isolated POL voltage without the need for either a direct connection to the POL or for noise sensitive, bandwidth limiting, isolation devices in the feedback path.

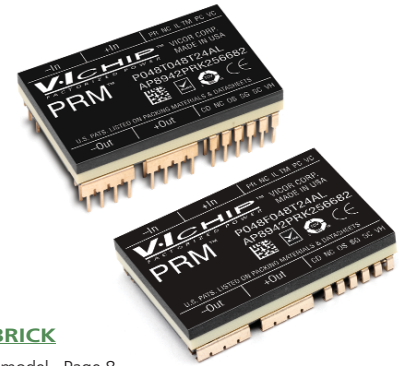

VI BRICK

[PRM model Page 8](#)

Features

- ZVS buck / boost regulator
- Provides factorized bus for 48 Vin VTMs
- Available in 24, 36 and 48 V models
- Efficiency: Up to 97%
- High density: Up to 1,105 W/in³
- Small footprint: 1.1 in² (7.1 cm²)
- 125°C operation (Tj)
- J-Lead package
- Through-hole pin option
- Pick & place / SMD compatible

[MIL-COTS Version Available](#)

[Page 34](#)

[Heat Sinks Available](#)

[Page 48](#)

Part Numbering For a complete listing of our PRM model numbers, go to vicorpower.com/vichip

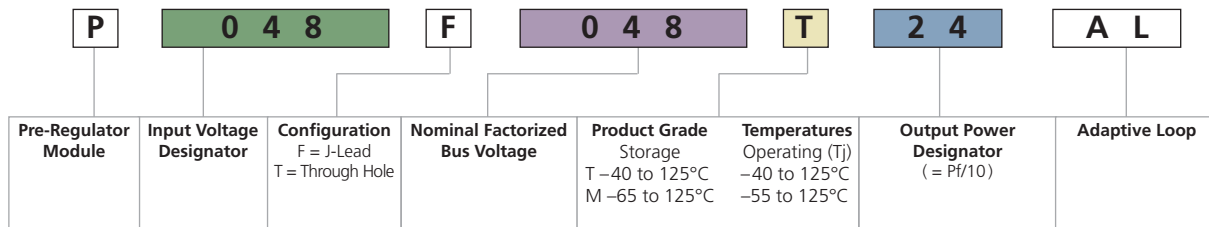

Input Voltage	Max Output		PRM Model No.	Trim / Vf Range
	Power	Current		
36 – 75 Vdc	240 W	5.0 A	P048F048T24AL	26 – 55 V
	120 W	2.5 A	P048F048T12AL	
38 – 55 Vdc	320 W	6.6 A	P045F048T32AL	
	170 W	3.5 A	P045F048T17AL	
18 – 36 Vdc	120 W	2.5 A	P024F048T12AL	
18 – 60 Vdc	120 W	2.5 A	P036F048T12AL	

Note: See individual data sheets for additional model specifications and configurations.

Application Examples

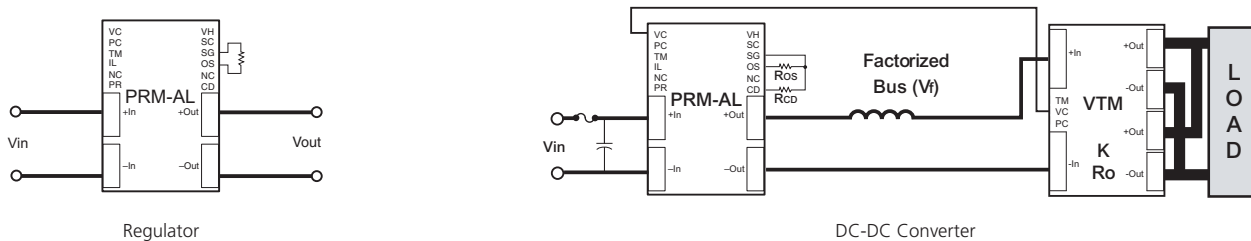

DC-DC V-I Chip

Web ExpressCode: **vtm**

VTM™ Voltage Transformer

RoHS

The VTM provides an isolated voltage to the point of load. Utilizing a Sine Amplitude Converter (SAC), it offers unprecedented performance in the critical areas of speed, noise, efficiency and density. VTMs address output requirements from 0.8 – 55 Vdc at up to 100 A, all in a surface-mount package only one-quarter of a cubic inch in volume. VTMs operate over an input voltage range of 26 – 55 Vdc — the "factorized bus" — and are a fixed-ratio device that requires a PRM or other stabilized voltage source for regulation.



Features

- Fixed ratio DC-DC converter
- Output: Up to 100 A / 300 W
- High density: Up to 345 A/in³
- Small footprint: 1.1in² (7.1 cm²)
- Low weight: 0.5 oz (15 g)
- Pick & place / SMD compatible
- Efficiency: Up to 97%
- 125°C operation (T_j)
- 1 μs transient response
- >3.5 million hours MTBF
- J-Lead package
- Through-hole pin option
- Isolation to 2,250 Vdc

VI BRICK

VTM model Page 9

Heat Sinks Available

Page 48

MIL-COTS Version Available

Page 34

Part Numbering For a complete listing of our VTM model numbers, go to vicorpower.com/vichip

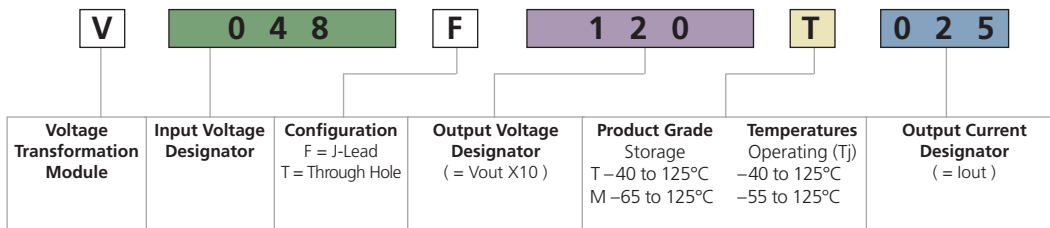

Input Voltage	K Factor	Vout		Output Current	VTM Model No.
		@ 48 Vin	Range		
26 – 55 Vdc	1/32	1.5 Vdc	0.82 – 1.71 Vdc	100 A	V048F015T100
	1/24	2.0 Vdc	1.09 – 2.29 Vdc	80 A	V048F020T080
	1/16	3.0 Vdc	1.63 – 3.43 Vdc	70 A	V048F030T070
	1/12	4.0 Vdc	2.17 – 4.58 Vdc	50 A	V048F040T050
	1/8	6.0 Vdc	3.25 – 6.87 Vdc	40 A	V048F060T040
	1/6	8.0 Vdc	4.34 – 9.16 Vdc	30 A	V048F080T030
	1/5	9.6 Vdc	6.40 – 11.00 Vdc	25 A	V048F096T025 ^[a]
	1/4	12.0 Vdc	6.50 – 13.80 Vdc	25 A	V048F120T025
	1/3	16.0 Vdc	8.67 – 18.30 Vdc	15 A	V048F160T015
	1/2	24.0 Vdc	13.80 – 26.50 Vdc	12 A	V048F240T012 ^[b]
	2/3	32.0 Vdc	17.30 – 36.70 Vdc	9 A	V048F320T009
	1	48.0 Vdc	26.00 – 55.00 Vdc	6 A	V048F480T006

^[a] Vout = 6.4 Vdc @ 32 Vin

^[b] Vout = 14.0 Vdc @ 28 Vin

VI BRICK PRM Thermally Enhanced Package

RoHS

The VI BRICK PRM is a very efficient non-isolated regulator designed to provide a controlled Factorized Bus distribution voltage for powering downstream VI BRICK or V•I Chip Voltage Transformation Modules. In combination, VI BRICK PRMs and VTMs form a complete DC-DC Converter subsystem offering all of the unique benefits of Vicor's Factorized Power Architecture (FPA): high density and efficiency; low noise operation; architectural flexibility; extremely fast transient response; elimination of bulk capacitance at the point of load (POL); in a brick style package.



Features

- 100°C baseplate operation
- Input voltages: 24, 36, 45 and 48 Vdc
- Low profile: 0.37 in. (9.5 mm)
- Low weight: 1.07 oz (30.3 g)
- Small footprint: 2.08 in²
- ZVS buck-boost regulator
- Efficiency: Up to 97%
- Fast transient response
- Low noise operation
- Rugged robust package
- Lead free wave solder compatible
- Agency approvals

MIL-COTS Version Available

[Page 34](#)

Part Numbering Ordering, see back cover for contacts

P R	0 4 8	A	4 8 0	T	0 2 4	F	P	
Pre-Regulator Module	Input Voltage Designator	Package Size	Output Voltage Designator (= V _{OUT} X 10)	Product Grade Storage T -40 to 125°C M -65 to 125°C	Temperatures Operating -40 to 100°C -55 to 100°C	Output Power Designator (= P _{OUT} / 10)	Baseplate F = Slotted flange P = Pin-fin heat sink ^[a]	Pin Style P = Through hole

^[a] Contact factory

Input Voltage	Max Output		PRM Model No.	Trim / Vf Range
	Power	Current		
36 – 75 Vdc	240 W	5.0 A	PR048A480T024FP	26 – 55 V
	120 W	2.5 A	PR048A480T012FP	
38 – 55 Vdc	320 W	6.6 A	PR045A480T032FP	
	170 W	3.5 A	PR045A480T017FP	
18 – 36 Vdc	120 W	2.5 A	PR024A480T012FP	
18 – 60 Vdc	120 W	2.5 A	PR036A480T012FP	

Note: See individual data sheets for additional model specifications and configurations.

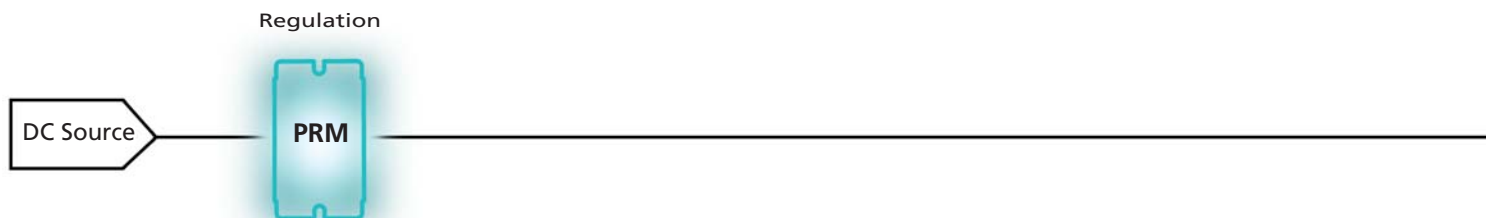

VI BRICK VTM Thermally Enhanced Package

RoHS

The VI BRICK VTM current multiplier excels at speed, density and efficiency to meet the demands of advanced power applications. Combined with the VI BRICK or V•I Chip PRM regulator the VI BRICK VTM creates a DC-DC converter with flexibility to provide isolation and regulation where needed. The PRM can be located with the VTM at the point of load or remotely in the back plane or on a daughtercard.



Features

- 100°C baseplate operation
- Up to 100 A or 300 W
- High density: Up to 390 W/in³
- Small footprint: 2.08 in²
- Low profile: 0.37 in. (9.5 mm)
- Low weight: 1.10 oz (31.3 g)
- ZVS / ZCS isolated sine amplitude converter
- Efficiency: Up to 97%
- <1 μs transient response
- Isolated output
- No output filtering required
- Lead free wave solder compatible
- Agency approvals

MIL-COTS Version Available

[Page 34](#)

Part Numbering Ordering, see back cover for contacts

V T	0 4 8	A	1 2 0	T	0 2 5	F	P	
Voltage Transformation Module	Input Voltage Designator	Package Size	Output Voltage Designator (= V_{out} X 10)	Product Grade Storage T -40 to 125°C M -65 to 125°C	Temperatures Operating -40 to 100°C -55 to 100°C	Output Current Designator (= I_{out})	Baseplate F = Slotted flange P = Pin-fin heat sink ^[a]	Pin Style P = Through hole

^[a] Contact factory

Input Voltage	K Factor	V _{out}		Output Current	VTM Model No.
		@ 48 Vin	Range		
26 – 55 Vdc	1/32	1.5 Vdc	0.82 – 1.71 Vdc	100 A	VT048A015T100FP
	1/24	2.0 Vdc	1.09 – 2.29 Vdc	80 A	VT048A020T080FP
	1/16	3.0 Vdc	1.63 – 3.43 Vdc	70 A	VT048A030T070FP
	1/12	4.0 Vdc	2.17 – 4.58 Vdc	50 A	VT048A040T050FP
	1/8	6.0 Vdc	3.25 – 6.87 Vdc	40 A	VT048A060T040FP
	1/6	8.0 Vdc	4.34 – 9.16 Vdc	30 A	VT048A080T030FP
	1/5	9.6 Vdc	6.40 – 11.00 Vdc	25 A	VT048A096T025FP ^[b]
	1/4	12.0 Vdc	6.50 – 13.80 Vdc	25 A	VT048A120T025FP
	1/3	16.0 Vdc	8.67 – 18.30 Vdc	15 A	VT048A160T015FP
	1/2	24.0 Vdc	13.80 – 26.50 Vdc	12 A	VT048A240T012FP ^[c]
2/3	32.0 Vdc	17.30 – 36.70 Vdc	9 A	VT048A320T009FP	
1	48.0 Vdc	26.00 – 55.00 Vdc	6 A	VT048A480T006FP	

Note: See individual data sheets for additional model specifications and configurations.

^[b] V_{out} = 6.4 Vdc @ 32 Vin ^[c] V_{out} = 14.0 Vdc @ 28 Vin

Transformation / Isolation

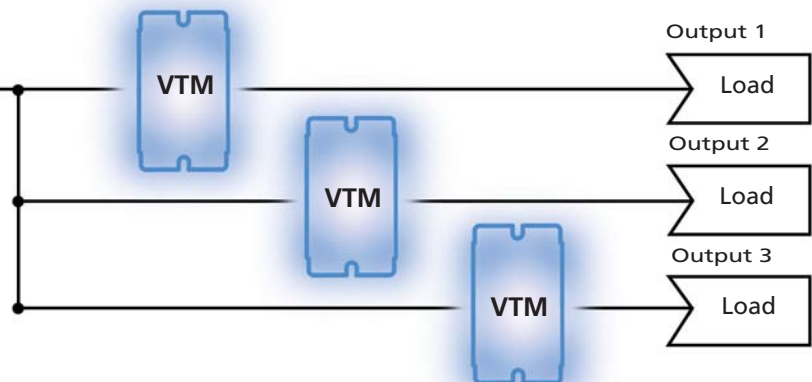

VI BRICK BCM Thermally Enhanced Package

RoHS

VI BRICK BCM modules use advanced Sine Amplitude Converter™ (SAC) technology, thermally enhanced packaging technologies, and advanced manufacturing processes to provide high power density and efficiency, superior transient response, and improved thermal management. These modules can be used to provide an isolated intermediate bus to power non-isolated POL converters and due to the fast response time and low noise of the BCM, capacitance can be reduced or eliminated near the load.



Features

- 100°C baseplate operation
- 48 V, 352, and 384 V Bus Converters
- High density: Up to 390 W/in³
- Small footprint: 2.08 in²
- Height above board: 0.37 in (9.5 mm)
- Efficiency: Up to 96%
- Isolated output
- No output filtering required
- <1 μs transient response
- Fast transient response
- Lead free wave solder compatible
- Agency approvals

Part Numbering Ordering, see back cover for contacts

B C	0 4 8	A	0 1 5	T	0 1 4	F	P	
Bus Converter Module	Input Voltage Designator	Package Size	Output Voltage Designator (= Vout X 10)	Product Grade Storage T -40 to 125°C M -65 to 125°C	Temperatures Operating -40 to 100°C -55 to 100°C	Output Power Designator (= Pout / 10)	Baseplate F = Slotted flange P = Pin-fin heat sink ^[a]	Pin Style P = Through hole

^[a] Contact factory

Input Voltage	K Factor	Vout		Max Power	BCM Model No.
		@ 48 Vin	Range		
38 – 55 Vdc	1/32	1.5 Vdc	1.19 – 1.71 Vdc	135 W	BC048A015T014FP
	1/16	3.0 Vdc	2.38 – 3.43 Vdc	210 W	BC048A030T021FP
	1/12	4.0 Vdc	3.17 – 4.58 Vdc	200 W	BC048A040T020FP
	1/8	6.0 Vdc	4.75 – 6.87 Vdc	240 W	BC048A060T024FP
	1/6	8.0 Vdc	6.34 – 9.16 Vdc	240 W	BC048A080T024FP
	1/5	9.6 Vdc	7.60 – 11.00 Vdc	240 W	BC048A096T024FP
	1/4	12.0 Vdc	9.50 – 13.80 Vdc	300 W	BC048A120T030FP
	1/3	16.0 Vdc	12.70 – 18.30 Vdc	240 W	BC048A160T024FP
	1/2	24.0 Vdc	19.00 – 26.50 Vdc ^[b]	300 W	BC048A240T030FP
	2/3	32.0 Vdc	25.30 – 36.70 Vdc	300 W	BC048A320T030FP
	1	48.0 Vdc	38.00 – 55.00 Vdc	300 W	BC048A480T030FP
330 – 365 Vdc	1/32	11.0 Vdc	10.3 – 11.4 Vdc	240 W	BC352A110T024FP
330 – 365 Vdc	1/32	11.0 Vdc	10.3 – 11.4 Vdc	300 W	BC352A110T030FP
360 – 400 Vdc	1/32	12.0 Vdc	11.3 – 12.5 Vdc	300 W	BC384A120T030FP

Note: See individual data sheets for additional model specifications and configurations.

^[b] Vin = 38 – 53 Vdc

Typical Application

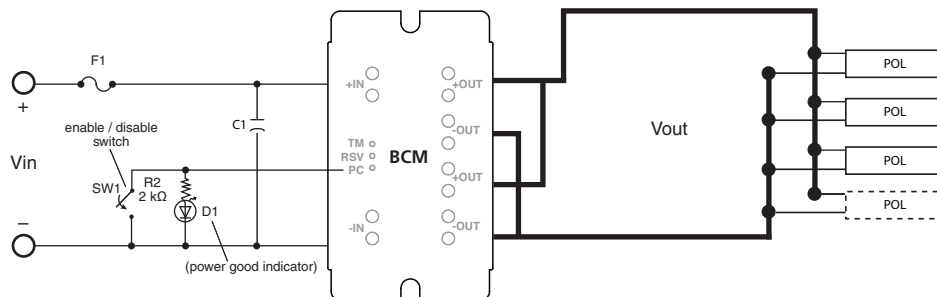

DC-DC VI BRICKS

Web ExpressCode: [vibdcdc](#)

VI BRICK DC-DC Converter

RoHS

VI BRICK DC-DC converters use advanced Sine Amplitude Converter (SAC) technology, thermally enhanced packaging technologies, and advanced CIM processes to provide high power density and efficiency, superior transient response, and improved thermal management. The high speed 3.5 MHz, zero-current switching / zero-voltage switching (ZCS / ZVS) design enables efficient and low noise operation throughout the entire operating range.

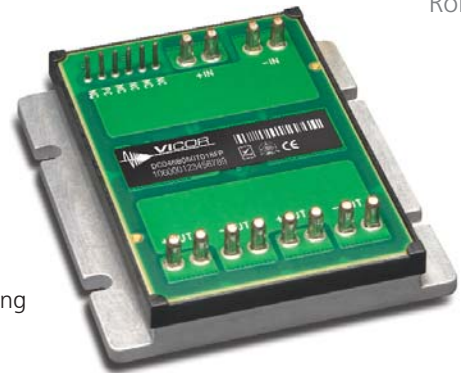

Features

- DC input range: 36 – 75 V
- Efficiency: Up to 93%
- DC output: 1 – 48 V
- Maximum operating temp: 100°C, full load
- Isolated output
- Low noise: Sine Amplitude Converter (SAC) technology
- Highly efficient: ZCS / ZVS switching
- Fast dynamic response
- Low profile: 0.37 in. (9.5 mm)
- Power density: Up to 145 W/in³
- Lead free wave solder compatible
- Agency approvals

Part Numbering Ordering, see back cover for contacts

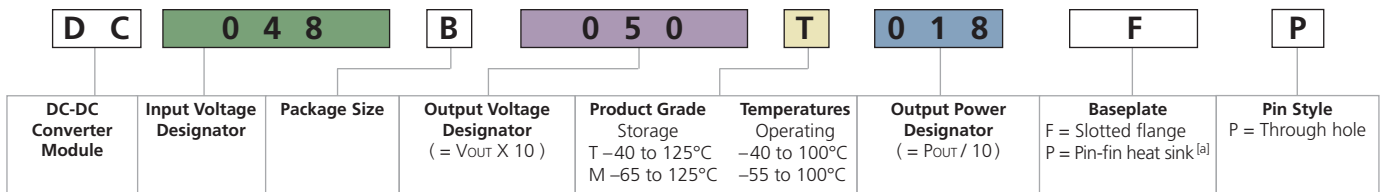

^[a] Contact factory

Output Voltage	Output Power (W)	Current (A)	Efficiency (%)	Part Numbering
1.0 Vdc	100	100	85	DC048B010T010FP
1.5 Vdc	120	80	87	DC048B015T012FP
1.8 Vdc	144	80	89	DC048B018T014FP
2.5 Vdc	175	70	90	DC048B025T017FP
3.0 Vdc	180	60	91	DC048B030T018FP
3.3 Vdc	165	50	91	DC048B033T016FP
5 Vdc	180	36	91	DC048B050T018FP
10 Vdc	180	18	92	DC048B100T018FP
12 Vdc	220	18.33	92	DC048B120T022FP
15 vdc	200	13.33	92	DC048B150T020FP
24 Vdc	220	9.17	92	DC048B240T022FP
28 Vdc	190	6.79	92	DC048B280T019FP
48 Vdc	220	4.58	93	DC048B480T022FP

VI-200 & VI-J00 Series Converter Modules

RoHS

VI-200 and VI-J00 converters feature wide input voltage ranges, remote sense, enhanced output programmability, logic disable, and low quiescent current. VI-200 product series feature output overvoltage protection and thermal shut down. VI-J00 product series, at half the size of VI-200 converters, operate to 100°C. Both product series are safety agency approved, accelerating your time to market.



Features

- Input voltage range: 10 – 400 Vdc
- Output voltages: 1 – 95 Vdc
- Output power (per module):
VI-200 Series: 50 – 200 W • VI-J00 Series: 25 – 100 W
- Parallelable for higher power (VI-200)
- 3,000 Vrms isolation
- 100°C operation: (85°C for VI-200 Series)
- Output voltage trim range: 50 – 110%
- Efficiency: Up to 90%
- Agency approvals: cULus, cTÜVus, CE Marked
- Dimensions:
VI-200 Series: 4.6" x 2.4" x 0.5"
(116,9 x 61,0 x 12,7 mm)
- VI-J00 Series: 2.28" x 2.4" x 0.5"
(57,9 x 61,0 x 12,7 mm)
- Weight:
VI-200 Series: 6.0 oz / 170 g
VI-J00 Series: 3.0 oz / 85 g
- Low-noise ZCS / ZVS power architecture
- 4 temperature grades

[MIL-COTS Version Available](#)

[Page 35](#)

[Battery Charging & Packaging Options](#)

[Page 23](#)

General Performance Refer to data sheet for detailed specifications

Parameter	C-, I-, M-Grade	E-Grade
Input voltage and output voltage	See chart on page 13	
Set point accuracy	0.5%	1.0%
Load / line regulation (max)	0.2%	0.5%
Output temperature drift	0.01%/°C	0.02%/°C
Peak-to-peak output ripple (max)	1.5%	3%
Trim range ^[a]	50 – 110%	50 – 110%
Total remote sense compensation	0.5 V	0.5 V
OVP set point (VI-200 Series only)	125%	125%
Current limit	105 – 125%	105 – 135%
Efficiency (output ≥5 V)	80 – 90%	78 – 88%
Power sharing accuracy (VI-200 Series only)	±5%	±5%
Input reflected ripple current	10%	10%
No-load power dissipation	1.35 W	1.35 W
Isolation		
Input to output	3,000 Vrms	3,000 Vrms
Input to baseplate	1,500 Vrms	1,500 Vrms
Output to baseplate	500 Vrms	500 Vrms
Max. baseplate temperature: VI-200 Series (VI-J00 Series)	85°C (100°C)	85°C (100°C)

^[a] 10 V, 12 V and 15 V outputs, standard trim range ±10-%. Consult factory for wider trim range. 95 V outputs cannot be trimmed up.

Visit vicorpower.com & get your [Design Guide](#)



Part Number Configuration Chart VI-200 & VI-J00

IMPORTANT NOTICE: PLEASE READ BEFORE STARTING

The part numbering format below is for Vicor VI-200 and VI-J00 DC-DC converters and configurables. The power levels shown are the maximum available for every input and output voltage combination. If you need more power than a VI-200 ("driver"), add parallel "booster" modules (of the same power level). For lower power versions use [PowerBench at vicorpower.com](#).

[Configure Your BRICK Online](#)



V I	-	J	6		1	-	C	W		
Family		Series	Input		Output			Grade	Output Power	
VI Non-RoHS		2 200	0 12 V	N 48 V	Z 2 V	M 10 V	K 40 V	E -10°C	≥ 5 V	< 5 V
VE RoHS		J J00	V 24 V	4 72 V	Y 3.3 V	1 12 V	4 48 V	C -25°C	U 200 W	U 40 A
		B Booster	1 24 V	T 110 V	0 5 V	P 13.8 V	H 52 V	I -40°C	V 150 W	V 30 A
			W 24 V	5 150 V	X 5.2 V	2 15 V	F 72 V	M -55°C	W 100 W	W 20 A
			2 36 V	6 300 V	W 5.5 V	N 18.5 V	D 85 V		X 75 W	X 15 A
			3 48 V	7 150/300 V	V 5.8 V	3 24 V	B 95 V		Y 50 W	Y 10 A
					T 6.5 V	L 28 V			Z 25 W	Z 5 A
					R 7.5 V	J 36 V				

Designators VI-200 & VI-J00 Family and Accessory Modules

		Maximum Power available for VI-2(B)xx-xx																					
		Output Voltages																					
Vin Designator	Input Voltage	2	3.3	5	5.2	5.5	5.8	6.5	7.5	10	12	13.8	15	18.5	24	28	36	40	48	52	72	85	95
		Z	Y	0	X	W	V	T	R	M	1	P	2	N	3	L	J	K	4	H	F	D	B
0	12 (10-20)	X	X	X	X	X	X	X	X	X	X	X	X	X	X	X	X	X	X	X	X	X	X
V	24 (10-36)	--	X	Y	Y	Y	Y	Y	X	X	X	X	X	X	X	X	X	X	X	--	--	--	--
1	24 (21-32)	U	U	U	U	U	U	V	V	U	U	U	U	U	U	U	U	U	U	U	U	U	U
W	24 (18-36)	V	V	V	V	V	V	W	W	V	V	V	V	V	V	V	V	V	V	V	V	V	V
2	36 (21-56)	W	V	W	W	W	W	W	W	W	W	W	W	W	W	W	W	W	W	W	--	--	--
3	48 (42-60)	U	U	U	U	U	U	U	U	U	U	U	U	U	U	U	U	U	U	U	U	U	U
N	48 (36-76)	V	U	U	U	U	U	U	U	U	U	U	U	U	U	U	U	U	U	U	U	U	U
4	72 (55-100)	U	U	U	U	U	U	V	V	U	U	U	U	U	U	U	U	U	U	U	U	U	U
T	110 (66-160)	V	V	V	V	V	V	W	W	V	V	V	V	V	V	V	V	V	V	V	V	--	--
5	150 (100-200)	U	U	V	V	V	V	V	V	U	U	U	U	U	U	U	U	U	U	U	U	U	U
7	150 (100-375)	W	W	Y	Y	Y	Y	W	W	W	W	W	W	W	W	W	W	W	W	W	--	--	--
6	300 (200-400)	U	U	U	U	U	U	V	V	U	U	U	U	U	U	U	U	U	U	U	U	U	U

		Maximum Power available for VI-Jxx-xx																					
		Output Voltages																					
Vin Designator	Input Voltage	2	3.3	5	5.2	5.5	5.8	6.5	7.5	10	12	13.8	15	18.5	24	28	36	40	48	52	72	85	95
		Z	Y	0	X	W	V	T	R	M	1	P	2	N	3	L	J	K	4	H	F	D	B
0	12 (10-20)	X	X	Y	Y	Y	Y	Y	Y	X	X	X	X	X	X	X	X	X	X	X	X	X	X
V	24 (10-36)	--	Y	Y	Y	Y	Y	Y	Y	Y	Y	Y	Y	Y	Y	Y	Y	Y	--	--	--	--	--
1	24 (21-32)	W	W	W	W	W	W	X	X	W	W	W	W	W	W	W	W	W	W	W	W	W	W
W	24 (18-36)	W	W	W	W	W	W	X	X	W	W	W	W	W	W	W	W	W	W	W	W	W	W
2	36 (21-56)	Y	Y	Y	Y	Y	Y	Y	Y	X	X	X	X	X	X	X	X	X	X	--	--	--	--
3	48 (42-60)	W	W	W	W	W	W	X	X	W	W	W	W	W	W	W	W	W	W	W	W	W	W
N	48 (36-76)	W	W	X	X	X	X	X	X	W	W	W	W	W	W	W	W	W	W	W	W	W	W
4	72 (55-100)	W	W	W	W	W	W	X	X	W	W	W	W	W	W	W	W	W	W	W	W	W	W
T	110 (66-160)	W	W	X	X	X	X	X	X	W	W	W	W	W	W	W	W	W	W	W	W	--	--
5	150 (100-200)	W	W	W	W	W	W	X	X	W	W	W	W	W	W	W	W	W	W	W	W	W	W
7	150 (100-375)	Y	Y	Y	Y	Y	Y	Y	Y	X	X	X	X	X	X	X	X	X	X	X	--	--	--
6	300 (200-400)	W	W	W	W	W	W	X	X	W	W	W	W	W	W	W	W	W	W	W	W	W	W

Note: See Design Guide & Applications Manual for VI-200 & VI-J00 Family, DC-DC Converters & Configurable Power Supplies

DC-DC BRICKS

Web ExpressCode: [bricks2](#)

Maxi, Mini, Micro Series Converter Modules

RoHS

Maxi, Mini, Micro Series DC-DC converter modules use advanced power processing, control, and packaging technologies to provide the performance, flexibility, and cost effectiveness expected of a mature power component. High-frequency ZCS / ZVS switching, advanced power semiconductor packaging, and thermal management provide high power density with low noise and high efficiency.

Features

- 24 V input: 18 – 36 Vdc
- 28 V input: 10 – 36 Vdc
- 48 V input: 36 – 75 Vdc
- 72 V input: 43 – 110 Vdc
- 110 V input: 66 – 154 Vdc
- 150 V input: 100 – 200 Vdc
- 300 V input: 180 – 375 Vdc
- 375 V input: 250 – 425 Vdc
- 100°C, no derating
- High efficiency
- Low-noise ZCS / ZVS
- Up to 120 W/in³
- 3,000 Vac isolation
- Single-wire paralleling
- Input undervoltage lockout
- Output overvoltage protection
- Overtemperature shut down
- Module fault alarm
- ZCS / ZVS power architecture
- Output voltage trim: 10 – 110%
- Bias supply to power external circuitry
- Logic enable / disable
- 5 temperature grades



Module Mounting & Interconnect Options
Page 50

MIL-COTS Version Available
Page 35

Configure Your BRICK Online

VICOR POWERBENCH
vicorpower.com/powerbench

General Performance Refer to data sheet for detailed specifications

Parameter	Specifications	Notes
Set point accuracy	±1% Vout nom.	Nominal input; full load; 25°C
Line regulation	±0.02% Vout nom.	Low line to high line; full load
Load regulation	±0.02% Vout nom.	No load to full load; nominal input
Temperature regulation	±0.002% Vout/°C	-20 to 100°C (C-Grade)
Remote sense compensation	0.5 V	Maxi and Mini only
Overvoltage set point	115% Vout nom.	
Current limit	115% Iout typ.	Vout 95% of nominal
Short-circuit current	115% Iout typ.	Output voltage <250 mV
Efficiency	Up to 90%	Nominal input; 80% load; 25°C
Programming range	10 – 110% Vout nom.	
Isolation voltage	3,000 Vrms	Input to output
Dimensions		
Maxi full-brick	4.6" x 2.2" x 0.5" (117 x 55,9 x 12,7 mm)	Up to 600 W
Mini half-brick	2.28" x 2.2" x 0.5" (57,9 x 55,9 x 12,7 mm)	Up to 300 W
Micro quarter-brick	2.28" x 1.45" x 0.5" (57,9 x 36,8 x 12,7 mm)	Up to 150 W
Agency approvals	cULus, cTÜVus, CE Marked	

Design Guide & Applications Manual Maxi, Mini, Micro Family DC-DC Converters & Accessory Modules

- High density DC-DC converter technology
- Control pin functions & applications
- Design requirements
- EMC considerations
- Current sharing in power arrays
- Thermal performance information
- Filter / autoranging rectifiers
- Modular AC front-end system
- High Boost HAM
- Filter Input Attenuator Module
- MIL-COTS Filter Input Attenuator
- Output ripple attenuator

Visit vicorpower.com & get your Design Guide



DC-DC BRICKS

Web ExpressCode: [prodselect](#)

Part Numbering Maxi, Mini & Micro Series Converters



Maxi example:
V24A48M400BN
24 Vin, Maxi, 48 Vout @ 400 W,
long ModuMate pins, slotted baseplate



Mini example:
V48B28C250BG
48 Vin, Mini, 28 Vout @ 250 W,
long RoHS pins, slotted baseplate



Micro example:
V375C24C150BG
375 Vin, Micro, 24 Vout @ 150 W,
long RoHS pins, slotted baseplate

V	48	A	48	C	500	B	L	
Input Voltage ^[a]		Package	Output Voltage ^[a]	Product Grade	Output Power		Pin Style	Baseplate
		A = Maxi B = Mini C = Micro		E = -10 to +100°C C = -20 to +100°C T = -40 to +100°C H = -40 to +100°C M = -55 to +100°C			Blank = Short tin / lead L = Long tin / lead S = Short ModuMate N = Long ModuMate F = Short gold (RoHS) G = Long gold (RoHS)	Blank = Slotted 2 = Threaded 3 = Through hole

^[a] Consult factory for other input / output / power models.

Designators Maxi, Mini, Micro Family

Input Voltage	Maximum Power available for Maxi (Full Brick)												
	Output Voltages												
	2 V	3.3 V	5 V	6.5 V	8 V	12 V	15 V	24 V	28 V	32 V	36 V	48 V	54 V
24 (18-36)	--	264 W	400 W	400 W	300 W	400 W	400 W	400 W	400 W	--	400 W	400 W	--
28 (10-36)	--	150 W	175 W	200 W	200 W	200 W	200 W	200 W	200 W	--	200 W	200 W	--
48 (36-75)	--	264 W	400 W	--	--	500 W	500 W	500 W	500 W	--	500 W	500 W	--
72 (43-110)	--	264 W	300 W	--	--	400 W	400 W	400 W	400 W	--	400 W	400 W	--
110 (66-154)	--	200 W	300 W	--	300 W	400 W	400 W	400 W	400 W	--	400 W	400 W	--
150 (100-200)	--	264 W	400 W	--	400 W	500 W	500 W	500 W	500 W	--	500 W	500 W	--
300 (180-375)	160 W	264 W	400 W	--	400 W	500 W	500 W	500 W	500 W	--	500 W	500 W	--
375 (250-425)	160 W	264 W	400 W	--	400 W	600 W	600 W	600 W	600 W	600 W	600 W	600 W	600 W

Input Voltage	Maximum Power available for Mini (Half Brick)												
	Output Voltages												
	2 V	3.3 V	5 V	6.5 V	8 V	12 V	15 V	24 V	28 V	32 V	36 V	48 V	54 V
24 (18-36)	--	150 W	200 W	--	200 W	200 W	200 W	200 W	200 W	--	200 W	200 W	--
48 (36-75)	100 W	150 W	200 W	--	--	250 W	250 W	250 W	250 W	--	250 W	250 W	--
72 (43-110)	--	100 W	150 W	--	150 W	250 W	250 W	250 W	250 W	--	250 W	250 W	--
110 (66-154)	--	100 W	150 W	--	150 W	200 W	200 W	200 W	200 W	--	200 W	200 W	--
150 (100-200)	--	150 W	200 W	--	200 W	250 W	250 W	250 W	250 W	--	250 W	250 W	--
300 (180-375)	100 W	150 W	200 W	--	200 W	250 W	250 W	250 W	250 W	--	250 W	250 W	--
375 (250-425)	100 W	150 W	200 W	--	200 W	300 W	300 W	300 W	300 W	--	300 W	300 W	--

Input Voltage	Maximum Power available for Micro (Quarter Brick)												
	Output Voltages												
	2 V	3.3 V	5 V	6.5 V	8 V	12 V	15 V	24 V	28 V	32 V	36 V	48 V	54 V
24 (18-36)	--	75 W	100 W	--	100 W	100 W	100 W	100 W	100 W	--	100 W	100 W	--
28 (9-36)	--	50 W	50 W	--	--	100 W	100 W	100 W	100 W	--	100 W	100 W	--
48 (36-75)	50 W	75 W	100 W	--	--	150 W	150 W	150 W	150 W	--	150 W	150 W	--
72 (43-110)	--	75 W	100 W	--	100 W	150 W	150 W	150 W	150 W	--	150 W	150 W	--
110 (66-154)	--	50 W	75 W	--	75 W	100 W	100 W	100 W	100 W	--	100 W	100 W	--
150 (100-200)	--	75 W	100 W	--	100 W	150 W	150 W	150 W	150 W	--	150 W	150 W	--
300 (180-375)	50 W	75 W	100 W	--	100 W	150 W	150 W	150 W	150 W	--	150 W	150 W	--
375 (250-425)	50 W	75 W	100 W	--	100 W	150 W	150 W	150 W	150 W	--	150 W	150 W	--

See [Vicor PowerBench Online](#) for intermediate power modules and to customize a solution.
See [Data Sheet](#) for detailed electrical specifications and intermediate power modules.

Cool-ORing™ Series Universal Active ORing Controllers

Web ExpressCode: [oring](#)

PI2001 / PI2002 / PI2003

RoHS

The Cool-ORing PI2001/2/3 are universal high-speed Active ORing controller IC solutions designed for use with N-channel MOSFETs in redundant power system architectures. The PI2001/2/3 Cool-ORing controllers enable an extremely low power loss solution with fast dynamic response to fault conditions, critical for high availability systems. The PI2001/3 control single or parallel MOSFETs to address Active ORing applications protecting against power source failures. The PI2003 is optimized for low side -48V Active ORing applications. An internal VC shunt regulator enables biasing of the controller directly from -48 V (GND). The PI2002 includes a load disconnect feature for use with back-to-back N-channel MOSFETs in redundant power architectures.

The gate drive output turns the MOSFET on in normal steady state operation, while achieving high-speed turn-off during input power source fault conditions, which cause reverse current flow, with auto-reset once the fault clears. The PI2002 has the added benefit of being able to protect against output load fault conditions that may induce excessive forward current and device over-temperature by removing gate drive from the back-to-back MOSFETs with an auto-retry programmable off-time.



Features

- Fast dynamic response to power source failures, with 160 ns reverse current turn-off delay time
- 4 A gate discharge current
- Accurate MOSFET drain-to-source voltage sensing to indicate system level fault conditions
- Programmable under and overvoltage detection
- Overtemperature fault detection
- Adjustable reverse current blanking timer
- Withstands 100 V transients in low-side applications
- Master / Slave I/O for paralleling (TDFN package only)
- Active-low fault flag output

Part Numbering

Part Number	Package	Target Application	Bias Supply	MOSFET Gate Drive Voltage	MOSFET Gate Discharge Current	Turn-off Delay Time	Shipment Packaging		
PI2001-00-QEIG	3 x 3 mm 10 Lead TDFN	Universal Low Voltage Active ORing	4.5 V – 13.2 V	8.5 V – 10.5 V	4 A (typ)	160 ns (typ.)	Tape and Reel		
PI2002-00-QEIG		Active ORing w/ Load Disconnect		9.0 V – 11.0 V		Reverse Fault, 120 ns (typ.) Forward Overcurrent, 150 ns (typ.)			
PI2003-00-QEIG		48 V Optimized Low Side Active ORing	Internal VC Clamp 10 V – 12 V	VC – 0.25 V		160 ns (typ.)			
PI2001-00-SOIG	8 Lead SOIC	Universal Low Voltage Active ORing	4.5 V – 13.2 V	8.5 V – 10.5 V		4 A (typ)		160 ns (typ.)	Tape and Reel
PI2002-00-SOIG		Active ORing w/ Load Disconnect		9.0 V – 11.0 V				Reverse Fault, 120 ns (typ.) Forward Overcurrent, 150 ns (typ.)	
PI2003-00-SOIG		48 V Optimized Low Side Active ORing	Internal VC Clamp 10 V – 12 V	VC – 0.25 V				160 ns (typ.)	

Evaluation Boards

- PI2001-EVAL1 PI2001 Evaluation Board using 3 x 3 mm TDFN package and SO-8 MOSFET in high-side configuration. (pg. 47)
- PI2002-EVAL1 PI2002 Evaluation Board using 3 x 3 mm TDFN package and back-to-back SO-8 MOSFETs in high-side configuration. (pg. 47)
- PI2003-EVAL1 PI2003 Evaluation Board using 3 x 3 mm TDFN package and 100 V SO-8 MOSFET in low-side configuration. (pg. 47)

Typical Application

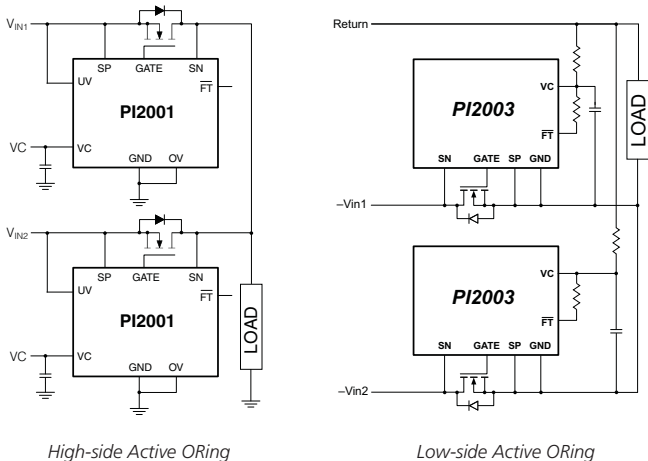

PI2001 performance

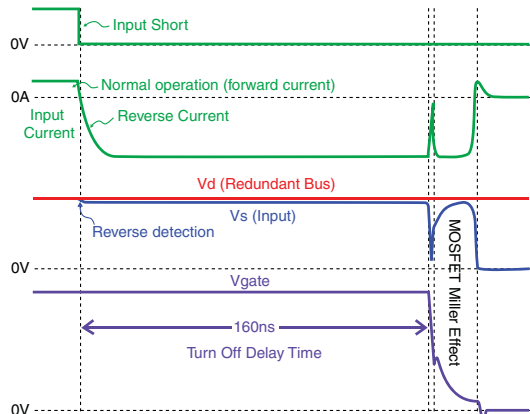

Typical dynamic response of the PI2001 to an input power source short circuit fault condition

Cool-ORing™ Series Full-Function Active ORing Solutions

Web ExpressCode: [oring2](#)

PI2121 / PI2122 / PI2123 / PI2125

RoHS

The Cool-ORing PI2121/3/5 are complete full-function Active ORing solutions each with a high-speed ORing MOSFET controller and a very low on-state resistance MOSFET designed for use in redundant power system architectures. The PI2121/3/5 Cool-ORing solutions are offered in an extremely small, thermally enhanced 5 x 7 mm LGA package and can be used in low voltage (≤ 5 V bus, ≤ 9.6 V bus and ≤ 12 V bus respectively) high side Active ORing applications. The PI2121/3/5 enable extremely low power loss with fast dynamic response to fault conditions, critical for high-availability systems. A master / slave feature allows the paralleling of PI2121/3/5 solutions for high-current, Active ORing requirements.

The PI2121/3/5 provide very high efficiency and low power loss during steady state operation, while achieving high-speed turn-off of the internal MOSFET during input power source fault conditions, which cause reverse current flow. The PI2121/3/5 provide an active low fault flag output to the system during excessive forward current, light load, reverse current, overvoltage, undervoltage and overtemperature fault conditions.

The PI2122 is configured with back-to-back MOSFETs designed for use in ≤ 5 V bus redundant power system architectures where added protection against load fault conditions is required. The back-to-back MOSFET provides a true bi-directional switch capability to disconnect load fault conditions that may induce excessive forward current and device over-temperature.

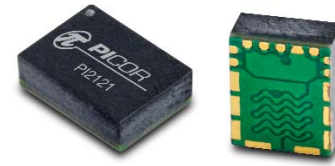

5 mm x 7 mm x 2 mm
Thermally Enhanced LGA

Features

- Combines a high-speed ORing MOSFET controller and low on-state resistance MOSFET
- Integrated high-performance MOSFET
PI2121: 8 V, 24 A, 1.5 m Ω
PI2122: 7 V, 12 A, 6 m Ω (back-to-back MOSFET)
PI2123: 15 V, 15 A, 3 m Ω
PI2125: 30 V, 12 A, 5.5 m Ω
- Very small, high density fully optimized solution
- Fast dynamic response to power source failures, with 160 ns reverse current turn-off delay time
- Accurate sensing capability to indicate system fault conditions
- Programmable under and overvoltage functions
- Overtemperature fault detection
- Adjustable reverse current blanking timer
- Master / Slave I/O for paralleling
- Active-low fault flag output

Part Numbering

Part Number	Package	Voltage Rating	Current Handling	Target Application	Internal MOSFET On-State Resistance	Bias Supply	Turn-off Delay Time	Shipment Packaging
PI2121-00-LGIZ	5 x 7 mm LGA	8 V (max)	24 A (max)	≤ 5 V Bus	1.5 m Ω (typ)	4.5 V – 13.2 V	160 ns (typ.)	Tape and Reel
PI2122-00-LGIZ		7 V (max)	12 A (max)	≤ 5 V Bus	6.0 m Ω (typ)			
PI2123-00-LGIZ		15 V (max)	15 A (max)	≤ 9.6 V Bus	3.0 m Ω (typ)			
PI2125-00-LGIZ		30 V (max)	12 A (max)	≤ 12 V Bus	5.5 m Ω (typ)			

Evaluation Boards

PI2121-EVAL1PI2121 Evaluation Board configured for a high-side ground referenced application. (pg. 47)

PI2122-EVAL1PI2122 Evaluation Board configured for a high-side application. (pg. 47)

PI2125-EVAL2PI2125 Evaluation Board configured for a high-side floating application. (pg. 47)

Note: Both PI2121-EVAL1 and PI2125-EVAL2 are compatible with the PI2123 solution.

Typical Applications

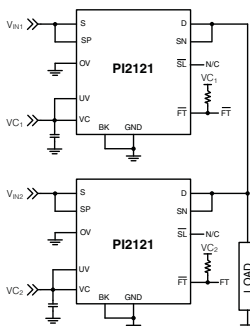

PI2121: High-side Active ORing

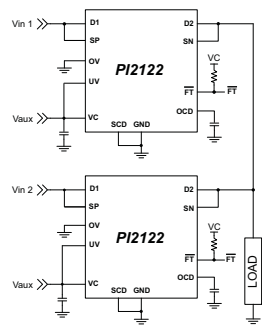

PI2122: High-side Active ORing with Load Disconnect

PI2121 / PI2123 / PI2125 Performance

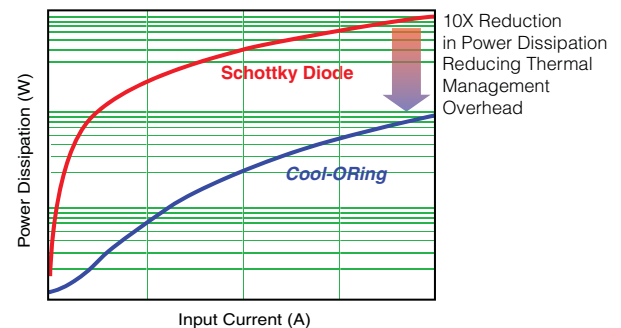

Power dissipation comparison between Picor's Cool-ORing solutions versus industry standard Schottky diode solutions

HAM Input Harmonic Attenuator Module

RoHS

The Harmonic Attenuator Module (HAM) accepts an input of 85 – 264 Vac. The “M” version provides a DC output compatible with Vicor’s 26x, J6x and user-defined Maxi, Mini and Micro DC-DC converters. The “L” version is compatible with V375 series DC-DC converters. The combination of a HAM, one or more Vicor DC-DC converters, and the 30205 [line filter, listed on Page 51](#), offers a high-density power solution meeting EN61000-3-2.



Features

- Power output: Up to 675 W
- Input: 85 – 264 Vac
- Meets EN61000-3-2
- 0.99 Power Factor
- Short-circuit protection
- High efficiency
- Input-surge limiting
- Dimensions:
4.6" x 2.4" x 0.5"
(117 x 61,0 x 12,7 mm)
- cULus, cTÜVus, CE Marked

Part Numbering Ordering, see back cover for contacts

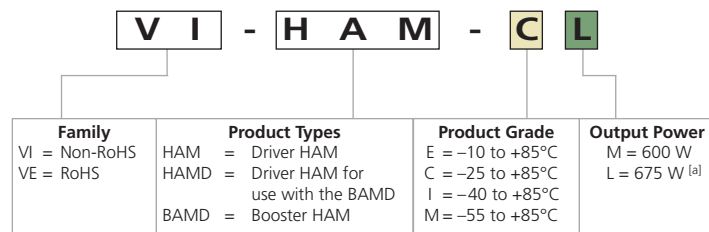

^[a] Compatible with V375 Maxi, Mini, Micro Series

Note: If power requirements exceed the capability of one HAM, use a HAMD and one or more BAMDs, with an external bridge rectifier. HAM, HAMD, and BAMD modules require three surge suppressors in series directly across the input. These surge suppressors are already contained in the EMI filter PIN 30205. Also, use a 10 A, 3AG fast-blow fuse ahead of the line filter.

General Performance Refer to data sheet for detailed specifications

Parameter	Specifications	Notes
AC line input	85 – 264 Vac 47 – 63 Hz	Continuous operation
Output power	Up to 675 W	
Efficiency	92%	
Power factor	0.99	
Total harmonic distortion ^[b]	<8.5%	
Output ripple	7 Vp-p	Cout = 1000 µF, 600 W
Inrush current	20 A peak	No external circuitry
Hold-up capacitance	500 – 3,000 µF	Power dependent
Isolation voltage		
Input to output	None	Provided by DC-DC converters
Input / output to baseplate	1,500 Vrms	
Auxiliary output	19 – 23 Vdc @ ≤3 mA	
Thermal shut down	90 to 100°C baseplate	
Short-circuit protection	Yes	
Weight	6 oz (170 g)	

^[b] With sinusoidal input voltage ITHD – VTHD = THD

Typical Configuration Not for design use; see data sheet for more information

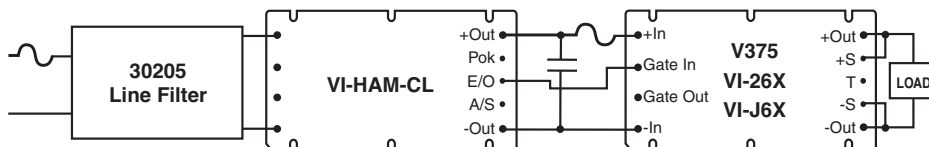

PFC FrontEnd 384 V Output

RoHS

The PFC FrontEnd from Westcor is a low-profile, 1 RU enclosed chassis-mount AC front end that may be used with any 375 Vin Vicor module, VIPAC Array, BCM, or other module to create a complete, high-density AC-DC power supply. Accepting universal input voltages of 85 – 264 Vac, and 100 – 380 Vdc, the PFC FrontEnd can deliver up to 2,200 Watts from four non-isolated outputs. With an extremely compact package size of 1.72" x 6.4" x 7" (43,6 x 162,6 x 177,8 mm), the PFC FrontEnd can provide >28 W/in³.

Besides meeting the UL, cTÜVus and CE Marked safety agency approvals, the PFC FrontEnd complies with harmonic current limits per EN61000-3-2, Electrical Fast Transient / burst EN61000-4-5. It also meets MIL-STD-810E for vibration.



Part Number

FE375-1

Features

- Power Factor Corrected (PFC)
- Low profile: 1.72" (43,6 mm)
- Output power: Up to 2,200 Watts
- High power density
- Up to four non-isolated outputs
- Output voltage: 384 V
- Integral cooling fans
- Meets MIL-STD-810E for vibration
- DIN rail mountable
- Safety agency approvals: cTÜVus, CE Marked

General Performance Refer to data sheet for detailed specifications

Product	Dimensions	Input Voltage	Output Power	Number of Outputs
PFC FrontEnd	1.72" x 6.4" x 7" (43,6 x 162,6 x 177,8 mm)	85 – 264 Vac	2,200 W @ 230 Vac	4 (non-isolated)
		47 – 800 Hz		
		100 – 380 Vdc	1,100 W @ 115 Vac	

Typical Configuration With VIPAC Array; see data sheet for more information

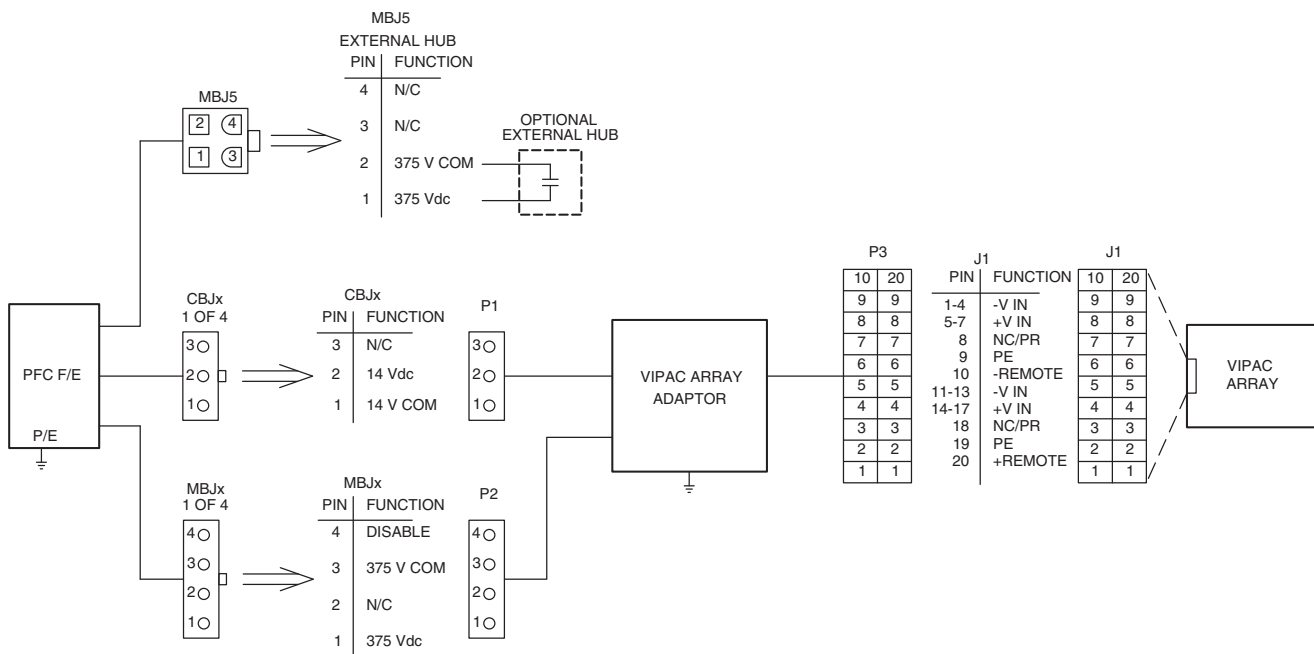

AIM AC Input Module

RoHS

The AIM (Alternating Input Module) is an AC front-end module which interfaces directly with worldwide AC mains. The AIM provides line rectification, EMI/RFI filtering, transient protection, and inrush limiting in a half-brick package measuring 2.28" x 2.4" x 0.5" (57,9 x 61,0 x 12,7 mm).

The AIM is used in conjunction with Vicor VI-200 or VI-J00 DC-DC converters to realize a universal AC input, high-density, low-profile switching power supply with outputs from 1 – 95 Vdc and a total power rating up to 200 W. An external capacitor is used to satisfy system hold-up requirements. Internal EMI filtering meets EN55022 and FCC Part 15, Class A emissions limits.



MIL-COTS Version Available

Page 35

Features

- Universal input: 85 – 264 Vac
- Output power: 250 W
- Operating temperature up to 100°C baseplate (no derating)
- Efficiency: 97%
- Integral EMI filtering
- Input transient protection
- Inrush limiting
- cULus, cTUVus, CE Marked

Part Numbering Ordering, see back cover for contacts

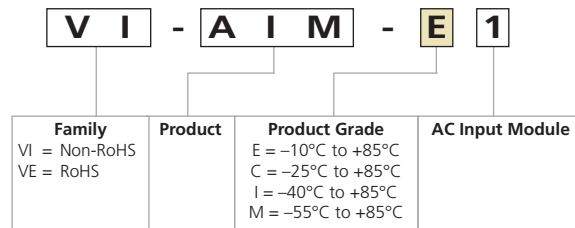

General Performance Refer to data sheet for detailed specifications

Parameter	Specifications	Notes
AC line input	85 – 264 Vac 47 – 440 Hz	No strapping No damage below low line
Output power	Up to 250 W	
Efficiency	97%	
Power factor	0.62	
Inrush current	<40 A peak	No external circuitry
Hold-up capacitance	270 – 1,200 µF	Power dependent
Isolation voltage		
Input to output	None	Provided by DC-DC converters
Input / output to baseplate	1,500 Vrms	
Short-circuit protection	No	
Weight	3 oz (85 g)	

Typical Configuration Not for design use; see data sheet for more information

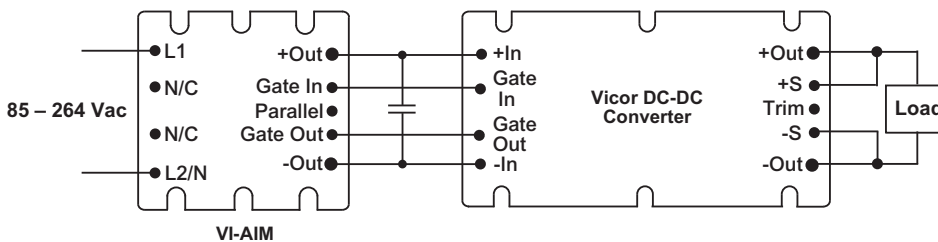

Autoranging Rectifier Module ARM

RoHS

The Autoranging Rectifier Module (ARM) is the front end of a switching power supply and uses a microprocessor to control strapping of the voltage doubler. The user only needs to add an input filter, hold-up capacitor and appropriate DC-DC converters to realize an autoranging, high-density, low-profile switching power supply.



Features

- Efficiency: 96 – 98%
- Operating temperature: Up to 100°C baseplate (no derating)
- Agency approvals: cTÜVus, cULus, CE Marked
- AC Bus OK, module enable
- Inrush limiting (no external circuitry)
- Autoranging input: 90 – 132 / 180 – 264 Vac

Part Numbering

Ordering, see back cover for contacts

V I - A R M - C 1 2 3				
Product	Product Grade	Type	Pin Style	Baseplate
Blank = 500 W / 750 W ^[a]	E = -10 to +100°C C = -20 to +100°C T = -40 to +100°C ^[c] H = -40 to +100°C ^[c] M = -55 to +100°C	1 = 500 W / 750 W 2 = 750 W / 1,500 W	1 = Short 2 = Long S = Short ModuMate N = Long ModuMate F = Short RoHS G = Long RoHS	Blank = Slotted 2 = Threaded 3 = Through hole
B = 750 W / 1,500 W ^[b]				

^[a] Valid combination with **Type 1** only

^[b] Valid combination with **Type 2** only

^[c] T-Grade storage temp. is -40°C; H-Grade storage temp. is -55°C

Filter / Autoranging Rectifier Module FARM

RoHS

The FARM (Filter / Autoranging Rectifier Module) is an AC front-end module which provides EMI filtering, autoranging line rectification, transient protection, and inrush current limiting.



Part Numbering

Ordering, see back cover for contacts

F A R M - 1 C 1 1				
Product	Type	Product Grade	Pin Style	Baseplate
	1 = 500 W / 750 W 2 = 750 W / 1,000 W	E = -10 to +100°C C = -20 to +100°C T = -40 to +100°C ^[d] H = -40 to +100°C ^[d]	1 = Short 2 = Long S = Short ModuMate N = Long ModuMate F = Short RoHS G = Long RoHS	1 = Slotted 2 = Threaded 3 = Through hole

^[d] T-Grade storage temp. is -40°C; H-Grade storage temp. is -55°C

General Performance for ARM & FARM

Refer to data sheet for detailed specifications

Parameter	ARM-()12	ARMB-()22	FARM1()21	FARM2()21
Input voltage	90 – 132 Vac 180 – 264 Vac		90 – 132 Vac 180 – 264 Vac	
Input frequency (C & E-Grade)	47 – 63 Hz		47 – 63 Hz	
Input frequency (T & H-Grade)	47 – 880 Hz		47 – 880 Hz	
Output power				
115 Vac input	500 Watts	750 Watts	500 Watts	750 Watts
230 Vac input	750 Watts	1,500 Watts	750 Watts	1,000 Watts
Compatible DC-DC converter	26x, J6x, V300		26x, J6x, V300	
Efficiency (typical)	97%		96%	
Inrush current (peak line. Cold start)	<30 A @ 264 Vac	<60 A @264 Vac	<30 A @ 264 Vac	<60 A @264 Vac
Dielectric withstand: Input /output	Provided by DC-DC converters		Provided by DC-DC converters	
I/O to baseplate	1,500 Vrms		1,500 Vrms	
Package	Micro		Mini	
Dimensions	2.28" x 1.45" x 0.5" (57,9 x 36,8 x 12,7 mm)		2.28" x 2.2" x 0.5" (57,9 x 55,9 x 12,7 mm)	
Operating temperature (C-Grade)	-20 to +100°C		-20 to +100°C	
Operating temperature (T-Grade)	-40 to +100°C		-40 to +100°C	
Weight	2.1 oz (60 g)		3.1 oz (87.9 g)	

ENMods Modular AC Front-end System

RoHS

The ENMod system is an AC front-end solution providing compliance to electromagnetic compatibility (EMC) standards. It consists of the MiniHAM passive harmonic attenuation module and the FARM3 autoranging AC-DC front-end module. Combined with filtering and hold-up capacitors, the ENMod system provides full compliance to EN61000-3-2 Harmonic Current, EN55022, Level B Conducted Emissions, EN61000-4-5 Surge Immunity, EN61000-4-11 Line Disturbances, and EN61000-3-3 Inrush Current. Unlike active PFC solutions, the MiniHAM generates no EMI, greatly simplifying and reducing system noise filtering requirements. It is also smaller and more efficient than active alternatives. Optimized for operation on the DC bus (provided by the FARM3) rather than directly on the AC line, it will provide harmonic current compliance at up to 600 W of input power at 230 Vac.

The FARM3 is a filter and autoranging module that has been optimized for use as the front end for the MiniHAM. Both modules are in Vicor's standard Mini half-brick package.



Features

- Passive harmonic current attenuation to EN61000-3-2
- 575 W rated power output
- Autoranging 115/230 Vac Input
- Inrush current limiting

Part Numbering

Ordering, see back cover for contacts

EN1C11			
Product Type^[a]	Product Grade (°C)	Pin Style^[b]	Baseplate
	E = -10 to +100 C = -20 to +100 T = -40 to +100 ^[c] H = -40 to +100 ^[c]	1 = Short 2 = Long S = Short ModuMate N = Long ModuMate F = Short RoHS G = Long RoHS	1 = Slotted 2 = Threaded 3 = Through hole

^[a] EN1 product includes one each MiniHAM and FARM3, same product grade, pin and baseplate style.

^[b] Pin styles S & N are compatible with ModuMate interconnect systems for socketing and surface mounting.

^[c] T-Grade storage temp. is -40°C; H-Grade storage temp. is -55°C

General Performance Refer to data sheet for detailed specifications

Parameter	Specification	Notes
Operating input voltage	90 – 132 Vac	Autoranging (doubler-mode)
	180 – 264 Vac	Autoranging (bridge-mode)
Output power (max)	575 Watts	
Harmonic currents	EN61000-3-2	50 – 600 W, 230 Vac input
Transient surge immunity	EN61000-4-5	2 kV – 50 μs line to earth
		1 kV – 50 μs line to line
Conducted emissions	EN55022, Class B	
Safety	EN60950	
Dimensions		
MiniHAM	2.28" x 2.2" x 0.5" (57,9 x 55,9 x 12,7 mm)	
FARM3	2.28" x 2.2" x 0.5" (57,9 x 55,9 x 12,7 mm)	

Typical Configuration Not for design use; see data sheet for more information

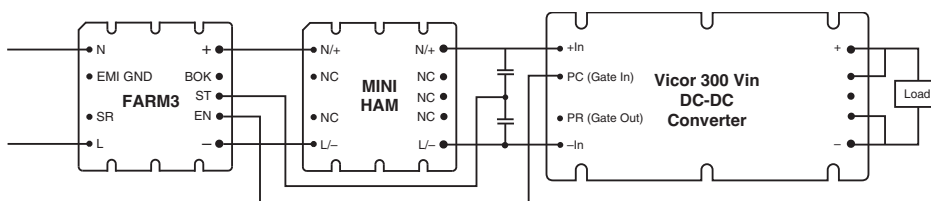

BatMod Battery Charger

RoHS

The fully-programmable BatMod current source module is based on the VI-200 Series of DC-DC converters. It accepts 48, 150, or 300 V inputs, provides programmable output current, and is well-suited for such applications as battery chargers, metal platers, and laser diodes. The BatMod is compatible with all major battery types, and is available in booster versions for higher output current applications.



Features

- Input voltages: 48, 150 or 300 V
- Programmable output current
- Booster versions for higher output current applications
- Agency approvals: cULus, cTUVus, CE Marked
- Dimensions: 4.6" x 2.4" x 0.5" (116,9 x 61,0 x 12,7 mm)

Part Numbering Ordering, see back cover for contacts

VI - 261 - EU - BM

Family	Module	Input Voltage		Output Voltage		Product Grade
VI = Non-RoHS VE = RoHS	2 = Driver B = Booster	Nominal	Range	Nominal	Range	
		3 = 48 V	42 – 60 V	1 = 12 V	11.25 – 16.5 V	E = –10 to +85°C
		5 = 150 V	100 – 200 V	3 = 24 V ^[a]	22.5 – 33.0 V	C = –25 to +85°C
		6 = 300 V	200 – 400 V	4 = 48 V	45.0 – 66.0 V	I = –40 to +85°C
						M = –55 to +85°C

^[a] Available in 300 V input only.

Packaging Options Chassis-mount housing VI-200 & VI-J00 Series, [page 33](#)

SlimMod
Flangeless package



2.28" L x 1.80" W x 0.50" H
(57,9 x 45,7 x 12,7 mm)



4.60" L x 1.80" W x 0.50" H
(116,8 x 45,7 x 12,7 mm)

To order the SlimMod configuration add the suffix "-S" to the standard module part number as shown on [Page 13](#).

FinMod
Flangeless package with integral heat sink

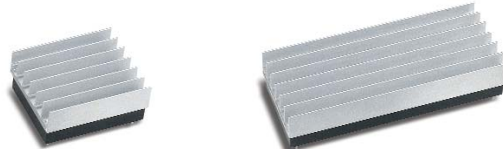

Longitudinal, 0.25" fins — add suffix "-F1"
Longitudinal, 0.50" fins — add suffix "-F2"



Transverse, 0.25" fins — add suffix "-F3"
Transverse, 0.50" fins — add suffix "-F4"

Available with longitudinal or transverse fins of 0.25" or 0.50" height. Add the appropriate suffix to the module part number as shown on [Page 13](#).

BusMod
Chassis mount housing with screw / lug wiring interface



2.28" L x 2.40" W x 1.08" H
(57,9 x 61,0 x 27,4 mm)



4.60" L x 2.40" W x 1.08" H
(116,8 x 61,0 x 27,4 mm)

To order the BusMod fully assembled, add suffix "-B1" to the standard module part number as shown on [Page 13](#).

To order the BusMod separately:
Half-sized BusMod — PIN 18952
Full-sized BusMod — PIN 06322

DC-DC Filters

Web ExpressCode: **fiam**

FIAM Filter Input Attenuator Module

RoHS

A DC input, front-end module providing transient protection, inrush current limiting and EMI filtering. The FIAM enables designers using Vicor Maxi, Mini, and Micro 48 Vin DC-DC converters to meet the transient immunity and EMI requirements of Telcordia, FCC, ETSI and European Norms.

Features

- EMI filtering - Class A
- Inrush current limiting
- Transient protection
- Input: 36 – 76 Vdc
- 10 and 20 Amp versions
- Agency approvals: cULus, cTUVus, CE Marked

MIL-COTS Version Available

Page 36



General Performance Not for design use; see data sheet

Parameter	Specification
Input voltage	36 – 76 Vdc
Output current	
FIAM1xxx / FIAM2xxx	10 A / 20 A
Inrush limiting	0.014 Amp/μF
EMI / RFI	Telcordia GR-1089-Core Issue 2, EN55022, Class A, FCC Part 15, Class B
Transient immunity	Telcordia GR-499-Core, Section 13-2, ETS 300 386-1, Class 2
Mini package dimensions	2.28" x 2.2" x 0.5" (57,9 x 55,9 x 12,7 mm)

Part Numbering Ordering, see back cover for contacts

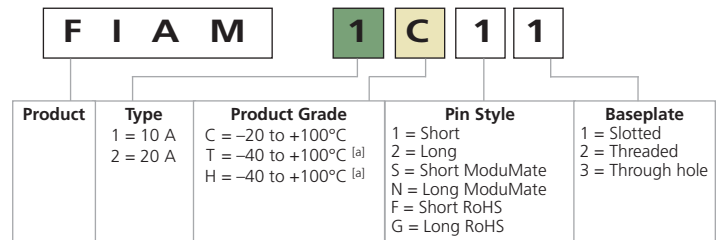

[a] T-Grade storage temp. is -40°C; H-Grade storage temp. is -55°C

Input Attenuator Module IAM

Web ExpressCode: **iam**

The IAM provides EMI filtering and transient protection for industrial and communications applications, using VI-200 and VI-J00 Series modules.

Features

- Meets Telcordia & British Telecom standards for EMI/RFI
- Meets Telcordia, IEC and British Telecom standards for transients
- Agency approvals: cULus, cTUVus, CE Marked
- Efficiency: 97%
- Input reverse polarity protection
- Dimensions: 2.28" x 2.4" x 0.5" (57,9 x 61,0 x 12,7 mm)

RoHS



MIL-COTS Version Available

Page 36

IAM Models & General Performance

Model	Input Voltage			Output Power
	Min.	Typ.	Max.	
VI-A11-CU	21 Vdc	24 Vdc	32 Vdc	200 W
VI-AWW-CU	18 Vdc	24 Vdc	36 Vdc	200 W
VI-A33-CQ	42 Vdc	48 Vdc	60 Vdc	400 W
VI-ANN-CQ	36 Vdc	48 Vdc	76 Vdc	400 W
VI-A66-CQ	200 Vdc	300 Vdc	400 Vdc	400 W

RoHS compliant versions begin with "VE-". For example: VE-A33-CQ

DC-DC Filters

Web ExpressCode: **ram**

RAM Ripple Attenuator Module

Combining active and passive filtering, the RAM attenuates both low-frequency input power source fundamental and harmonics, and high-frequency switching components in the frequency range of DC to 20 MHz, while exhibiting efficiencies of 93 – 99%. No adjustments are required, and remote sense and output voltage trim features are retained.

Features

- Reduces output ripple to <3 mV pp (VI-200)
- Compatible with VI-200 / VI-J00 based products: 5 – 50 Vdc output
- Full attenuation up to 20 A
- No adjustments required
- Efficiency: 93 – 99%
- Converter sense, trim, overvoltage, and overcurrent retained
- Dimensions: 2.28" x 2.4" x 0.5" (57,9 x 61,0 x 12,7 mm)
- CE Marked

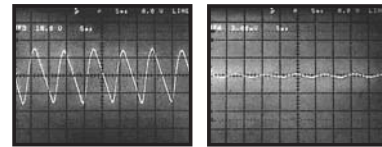

Input to VI-RAM

Low Noise Output

Typical Configuration Not for design use; see data sheet

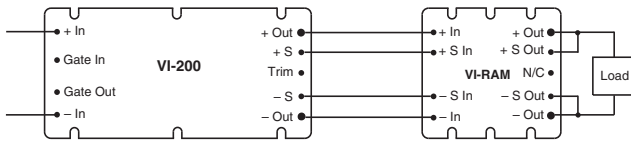

Part Numbering Ordering, see back cover for contacts

VI		- RAM -		C 2	
Family	Product	Product Grade	Type		
VI = Non-RoHS VE = RoHS		E = -10 to +100°C C = -25 to +100°C I = -40 to +100°C M = -55 to +100°C	1 = Up to 10 Amps 2 = Up to 20 Amps		

Output Ripple Attenuator Module MicroRAM

Web ExpressCode: **uram**

Combines both active and passive filtering to achieve greater than 40 dB of noise attenuation from 60 Hz to 1 MHz.

Features

- Integrated ORing diode supports N+1 redundancy
- >40 dB ripple attenuation from 60 Hz to 1 MHz
- Significantly improves load transient response
- Reduces ripple to less than 10 mV peak to peak
- Efficiency: Up to 98%
- 20 and 30 Amp ratings
- 3 – 30 Vdc input range
- Dimensions: 2.28" x 1.45" x 0.5" (57,9 x 36,8 x 12,7 mm)
- Compatible with Vicor's DC-DC converters

Typical Configuration Not for design use; see data sheet

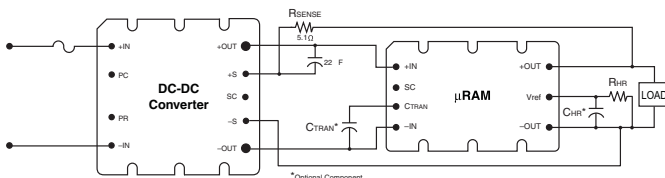

MIL-COTS Version Available

Page 36

Part Numbering Ordering, see back cover for contacts

μ RAM		2 C 2 1		
Product	Type	Product Grade (°C)	Pin Style	Baseplate
	2 = 20 Amps 3 = 30 Amps	C = -20 to +100 T = -40 to +100 ^[a] H = -40 to +100 ^[a] M = -55 to +100	1 = Short 2 = Long S = Short ModuMate N = Long ModuMate F = Short RoHS G = Long RoHS	1 = Slotted 2 = Threaded 3 = Through hole

^[a] T-Grade storage temp. is -40°C; H-Grade storage temp. is -55°C

Active Filters QPI Family

Web ExpressCode: **qpi**

QPI-3LZ through QPI-12LZ Active EMI Filters

RoHS

The QPI family of active EMI filters provides conducted common-mode (CM) and differential-mode (DM) attenuation from 150 kHz to 30 MHz (CISPR22 range). The proprietary active filtering circuit provides superior attenuation at low frequencies intended to support EN Class B limits, including PICMG® 3.0 for ATCA.

Models QPI-3LZ through QPI-8LZ are designed to work with most switch-mode power supplies. The QPI-9LZ through QPI-12LZ products are designed specifically for use with Vicor's V•I Chip power conversion products.

The QPI series are SiP (System-in-Package) solutions with Land Grid Array (LGA) mounting. The QPI-3LZ through QPI-10LZ are full size 25 x 25 x 4,5 mm packages and the QPI-11LZ and QPI-12LZ are half-size 12,5 x 25 x 4,5 mm packages. The QPI series is also available in an open frame SiP platform by ordering with the "-01" suffix.



Patents Pending



QPI Evaluation Boards Available pg. 47

For more information, go to picorpower.com



Features

- 24/28 V and 48/60 V models
- Efficiency: >99% at full load
- High density, low profile surface mount LGA package
- Integrated Hot-Swap in selected models
- Supports PICMG® 3.0 ATCA requirements
- Compatible with most DC-DC converters
- -40°C to +100°C PCB temperature
- TÜV approved

Part Numbering

Part Number (-01 = Open Frame) ^[a]	Input Voltage	Nominal Range	Current Rating	CM Attenuation @ 250 kHz	DM Attenuation @ 250 kHz	Hipot	Hot-Swap
QPI-3LZ	24/28 Vdc	10 – 40 Vdc	7 A	60 dB	80 dB	707 Vdc	N/A
QPI-3LZ-01	24/28 Vdc	10 – 40 Vdc	7 A	60 dB	80 dB	707 Vdc	N/A
QPI-4LZ	48/60 Vdc	30 – 80 Vdc	7 A	40 dB	70 dB	1,500 Vdc	N/A
QPI-4LZ-01	48/60 Vdc	30 – 80 Vdc	7 A	40 dB	70 dB	1,500 Vdc	N/A
QPI-5LZ	24/28 Vdc	10 – 40 Vdc	14 A	60 dB	80 dB	707 Vdc	N/A
QPI-5LZ-01	24/28 Vdc	10 – 40 Vdc	14 A	60 dB	80 dB	707 Vdc	N/A
QPI-6LZ	48/60 Vdc	30 – 80 Vdc	14 A	40 dB	80 dB	1,500 Vdc	N/A
QPI-6LZ-01	48/60 Vdc	30 – 80 Vdc	14 A	40 dB	80 dB	1,500 Vdc	N/A
QPI-7LZ	24/28 Vdc	18 – 38 Vdc	6 A	50 dB	80 dB	707 Vdc	Yes
QPI-7LZ-01	24/28 Vdc	18 – 38 Vdc	6 A	50 dB	80 dB	707 Vdc	Yes
QPI-8LZ	48/60 Vdc	32 – 76 Vdc	6 A	40 dB	70 dB	1,500 Vdc	Yes
QPI-8LZ-01	48/60 Vdc	32 – 76 Vdc	6 A	40 dB	70 dB	1,500 Vdc	Yes

V•I Chip Specific Models

			@ 1 MHz	@ 1 MHz			
QPI-9LZ	24/28 Vdc	18 – 38 Vdc	6 A	65 dB	80 dB	707 Vdc	Yes
QPI-9LZ-01	24/28 Vdc	18 – 38 Vdc	6 A	65 dB	80 dB	707 Vdc	Yes
QPI-10LZ	48/60 Vdc	32 – 76 Vdc	6 A	45 dB	70 dB	1,500 Vdc	Yes
QPI-10LZ-01	48/60 Vdc	32 – 76 Vdc	6 A	45 dB	70 dB	1,500 Vdc	Yes
QPI-11LZ	24/28 Vdc	5 – 50 Vdc	7 A ^[b]	65 dB	80 dB	707 Vdc	N/A
QPI-11LZ-01	24/28 Vdc	5 – 50 Vdc	7 A ^[b]	65 dB	80 dB	707 Vdc	N/A
QPI-12LZ	48/60 Vdc	10 – 80 Vdc	7 A ^[b]	45 dB	70 dB	1,500 Vdc	N/A
QPI-12LZ-01	48/60 Vdc	10 – 80 Vdc	7 A ^[b]	45 dB	70 dB	1,500 Vdc	N/A

^[a] Open-frame units are compatible with aqueous cleaning processes.

^[b] Parallelable for up to 12 A.

Typical Configuration Not for design use; see data sheet

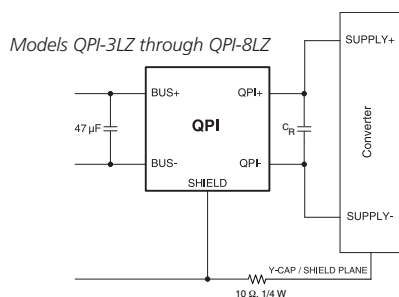

Performance

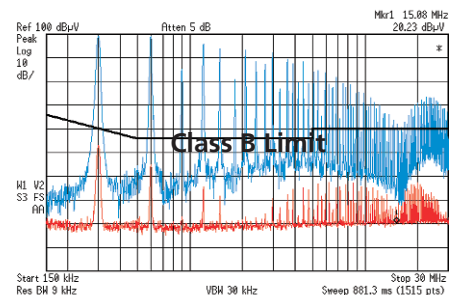

Conducted EMI scans showing QPI performance. Blue trace = no QPI; Red trace = with QPI.

Active Filters QPO Family

Web ExpressCode: **qpo**

QPO-1LZ / QPO-2LZ Output Ripple Attenuator

RoHS

The QPO output ripple attenuator products use proprietary active filtering to reduce power supply output ripple and noise (PARD) over 30 dB from 1 kHz to 500 kHz. QPOs improve transient response and ensure quiet point-of-load regulation. They also reduce the number of output capacitors to support dynamic loads. QPOs work with most DC-DC converters and switching power supplies. Output regulation is maintained using remote sensing or the trim input of the power supply.

Features

- >30 dB PARD attenuation, 1 kHz to 500 kHz
- Supports precise point-of-load regulation
- Efficiency: Up to 99%
- High density, low profile LGA package
- Reduces required number of output capacitors to support dynamic loads
- User selectable optimization of attenuation, power dissipation, and transient load response
- Compatible with most DC-DC converters



Patents Pending

Part Numbering

Part Number (-01 = Open Frame) ^[a]	Input Voltage	Current Rating	Attenuation
QPO-1LZ	3 – 30 Vdc	10 A	> 30 dB PARD attenuation, 1 kHz to 500 kHz
QPO-1LZ-01	3 – 30 Vdc	10 A	> 30 dB PARD attenuation, 1 kHz to 500 kHz
QPO-2LZ	0.3 – 5.5 Vdc	20 A	> 20 dB PARD attenuation, 1 kHz to 500 kHz, Aux. Bus biased
QPO-2LZ-01	0.3 – 5.5 Vdc	20 A	> 20 dB PARD attenuation, 1 kHz to 500 kHz, Aux. Bus biased

^[a] Open-frame units are compatible with aqueous cleaning processes.

Typical Application

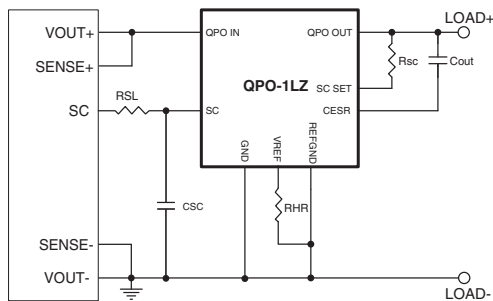

QPO Evaluation Boards Available pg. 47

For more information, go to picorpower.com

Performance

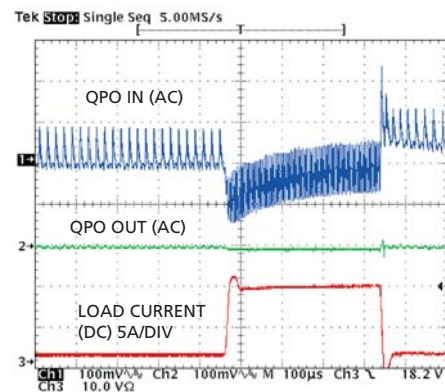

FlatPAC Family 50 – 600 Watt Power System

RoHS

The FlatPAC is a complete, low-profile, agency-approved switching power supply. It combines Vicor's VI-200 Series of DC-DC converters and front-end subassemblies to provide from 50 – 600 W of output power from one to three outputs.

The FlatPAC design provides rapid turnaround on standard models. FlatPAC is available with [BatMod current source module, Page 23](#).



Features

- Microprocessor-controlled front end
- Inputs: 115/230 Vac, autoranging
- FCC Part 15, Class B, EN55022, Class B
- 40 ms hold up
- Agency approvals: cULus, cTUVus, CE Marked
- Module disable
- BUS OK and AC OK
- Finned or conduction-cooled package
- 22 Standard output voltages from 1 – 95 Vdc
- Low-noise ZCS / ZVS power topology
- Transient surge: EN61000-4-5
- Low profile only 1.37" (34,7 mm)
- Custom output voltages also available
- BatMod current-source option available

General Performance Refer to data sheet for specifications

Parameter	Specification
Number of outputs	1 to 3
Output power	Up to 600 W
Input voltage	90 – 132 Vac / 180 – 264 Vac 47 – 63 Hz (400 Hz available; contact factory)
Conducted EMI	EN/FCC "B"
Set point	±1% max. (E-Grade 2%)
Load / line regulation	0.2% max. (E-Grade 0.5%)
Output ripple (pp)	150 mV or 3% max. (E-Grade 5%)
Trim range ^[a]	50 – 110%
Remote sense range	0.5 Vdc max.
OVP set point	125% typical
Current limit	115%
Maximum temperature	0 to 85°C baseplate

^[a] 10, 12 and 15 V outputs, standard trim range ± 10%.
Consult factory for wider trim range.

Chassis Configurations

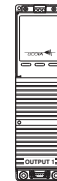

- Single output
- 50 – 200 Watts
- 9.25" x 2.5" x 1.37" (234,8 x 63,5 x 34,8 mm)

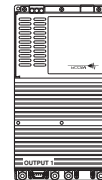

- Single or dual outputs
- 100 – 400 Watts
- 9.25" x 4.9" x 1.37" (234,8 x 124,5 x 34,8 mm)

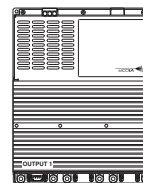

- Single, dual or triple outputs
- 150 – 600 Watts
- 9.25" x 7.3" x 1.37" (234,8 x 185,4 x 34,8 mm)

Part Numbering

VI	M	U	3		C	Q		
(VE) = RoHS Compliant								
Family	Input	Out 1	Out 2 ^[b]	Out 3 ^[c]	Grade	Power 1	Power 2 ^[b]	Power 3 ^[c]
L = Single M = Single N = Single P = Dual Q = Dual R = Triple	U = Autoranging 90 – 132 and 180 – 264 Vac	Z = 2 V Y = 3.3 V O = 5 V X = 5.2 V W = 5.5 V V = 5.8 V T = 6.5 V R = 7.5 V	M = 10 V 1 = 12 V P = 13.8 V 2 = 15 V N = 18.5 V 3 = 24 V L = 28 V J = 36 V	K = 40 V 4 = 48 V H = 52 V F = 72 V D = 85 V B = 95 V	E = 0°C C = 0°C I = -30°C	M = 600 W P = 450 W Q = 400 W S = 300 W U = 200 W V = 150 W W = 100 W X = 75 W Y = 50 W	U = 200 W V = 150 W W = 100 W X = 75 W Y = 50 W	U = 200 W V = 150 W W = 100 W X = 75 W Y = 50 W
All voltages available for output 1, 2, or 3								

For conduction-cooled package add -CC to the part number. For example, VI-LU0-CV-CC.

^[b] For P, Q, R, PJ, and RJ only. Refer to output configuration chart above.

^[c] For R and RJ only. Refer to output configuration chart above.

AC-DC Configurable Power Supplies

Web ExpressCode: [pfclatpac](#)

PFC FlatPAC Single Output Power System

RoHS

The PFC FlatPAC uses Vicor's field-proven VI-HAM and Maxi DC-DC converters to deliver up to 575 watts of clean, reliable power. The PFC FlatPAC is a single-output power supply available with standard output voltages from 3.3 – 54 Vdc. It operates from an input of 85 – 264 Vac, includes active power factor correction (0.99 power factor), and meets EN61000-3-2 harmonic current limits. Internal filtering provides compliance to EN55022-A conducted EMI. It is available in Vicor's low profile 1.37" (34,8 mm) FlatPAC chassis, in either finned or conduction-cooled (CC) versions.



Features

- Input: 85 – 264 Vac
- Power factor: 0.99
- Single output: Up to 80 A or 575 W, 3.3 – 54 Vdc
- Low profile package: 1.37" x 4.9" x 9.25" (34,8 x 124,4 x 235 mm)
- Safety agency approvals: cULus, cTUVus, CE Marked
- High efficiency
- Remote sense
- Current limit
- Thermal shut down
- OVP

General Performance Refer to data sheet for detailed specifications

Parameter	Rating	Unit	Notes
Input			
Voltage	85 – 264	Vac	
Frequency	47 – 63	Hz	
	47 – 440	Hz	I-Grade
Regulation line / load	0.5	%	10 to 100% load
Mechanical			
Weight	44.8 (1,304)	oz (g)	
Dimensions	1.37 x 4.9 x 9.25	inches	
	24,8 x 1,244 x 235	mm	
Operating temperature (case)			
C-Grade and E-Grade	0 to +85	°C	
I-Grade	-30 to +85	°C	
Storage temperature (case)			
E-Grade	-10 to +100	°C	
C-Grade	-30 to +100	°C	
I-Grade	-55 to +100	°C	

Part Numbering Ordering, see back cover for contacts

VI - C M U **3** - **C** **M** -

(VE) = RoHS Compliant

Input	Output Voltage	Product Grade (°C)	Output Power	Options
Universal 85 – 264 Vac	Y = 3.3 V 3 = 24 V 0 = 5.0 V L = 28 V 1 = 12 V J = 36 V 2 = 15 V 4 = 48 V G = 54 V	E = 0 to 85°C case C = 0 to 85°C case I = -30 to 85°C case	Vout ≤ 5 V Vout ≥ 12 V Q = 80 A M = 575 W	-CC = Conduction Cooled

AC-DC Configurable Power Supplies

Web ExpressCode: [vipac](#)

VIPAC Power System Choice of Chassis Configurations

RoHS

The VIPAC is an integrated power system leveraging the latest advances in DC-DC converter technology and modular front ends. VIPAC combines application-specific power processing units (PPU), a choice of chassis styles and remotely located hold-up capacitors to provide fast, flexible, and highly reliable power solutions for a wide range of demanding applications.

The PPU is the core element of the system and incorporates Vicor's autoranging FARM modular front end to provide transient protection, EMI filtering, and inrush current limiting. The PowerBench VIPAC Design Center enables designers to configure the PPU with up to three independently regulated outputs having power levels from 50 – 500 W and with as much as 900 W total output power.

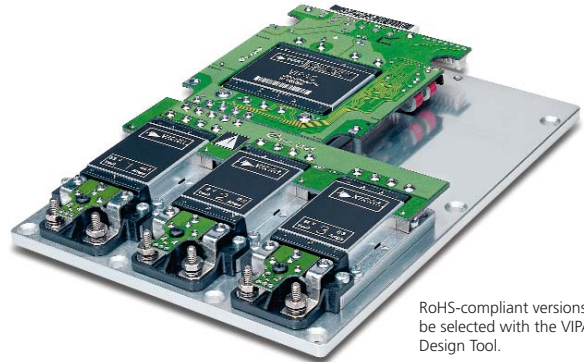

RoHS-compliant versions can be selected with the VIPAC Design Tool.

Features

- AC input: 115/230 Vac autoranging, 47 – 440 Hz
- Output voltages: 2 – 48 Vdc
50 – 900 Watts total;
1, 2, or 3 outputs
- Protective features:
Inrush current limiting
Input transient protection
EMI filtering
- Choice of output terminations:
LugMate or PlugMate
- Local or remote control
- Package style:
Low-profile coldplate
Optional finned heat sink
- Agency approvals:
cULus, cTUVus, CE Marked

[Configure Your VIPAC Power System Online](#)



vicorpower.com/vcad

Chassis Configurations Dimensions vary with specific model configurations

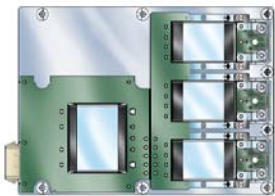

- 3 Micros**
- Dual or triple output
 - Up to 450 W
 - 4.96" x 6.8" x 0.75"^[a]
(126,0 x 172,7 x 19,0 mm)

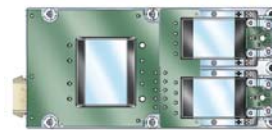

- 2 Micros**
- Single or dual output
 - Up to 300 W
 - 3.15" x 6.8" x 0.75"^[a]
(80,0 x 172,7 x 19,0 mm)

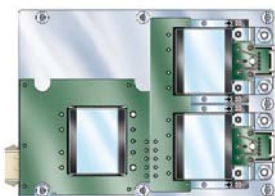

- 2 Minis**
- Single or dual output
 - Up to 500 W
 - 4.96" x 6.8" x 0.75"^[a]
(126,0 x 172,7 x 19,0 mm)



- 1 Mini**
- Single output
 - Up to 250 W
 - 3.15" x 6.8" x 0.75"^[a]
(80,0 x 172,7 x 19,0 mm)

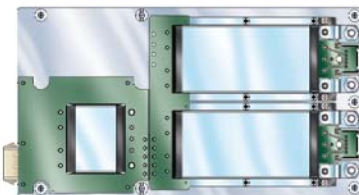

- 2 Maxis**
- Single or dual output
 - Up to 900 W
 - 4.96" x 9.15" x 0.75"^[a]
(126,0 x 232,4 x 19,0 mm)



- 1 Maxi**
- Single output
 - Up to 500 W
 - 3.15" x 9.15" x 0.75"^[a]
(80,0 x 232,4 x 19,0 mm)

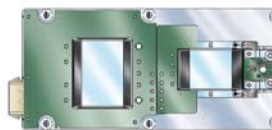

- 1 Micro**
- Single output
 - Up to 150 W
 - 3.15" x 6.8" x 0.75"^[a]
(80,0 x 172,7 x 19,0 mm)

^[a] PlugMate version is 0.81" (20,5 mm) in height

DC-DC Configurable Power Supplies

VIPAC Arrays DC Input Power System • 1 – 4 Outputs

Web ExpressCode: [vipacarray](#)

RoHS

The VIPAC Arrays are a highly flexible system of DC input power building blocks which can be configured with as many as four user-definable outputs on a low-profile, coldplate chassis. Using Vicor's VCAD design tool ([vicorpower.com/vcad](#)), designers are able to specify VIPAC Arrays with inputs of 24, 28, 48, 72, 110, 150, 300, 375 Vdc and outputs from 2 to 54 Vdc at power levels up to 600 watts per output. VIPAC Arrays are ideal for use in distributed and modular power systems where power density and reliable operation are critical. A current share option is available on single output models enabling them to be used in applications requiring high power / redundancy. Fully connectorized input and output terminations speed system installation and a versatile coldplate chassis simplifies thermal management.

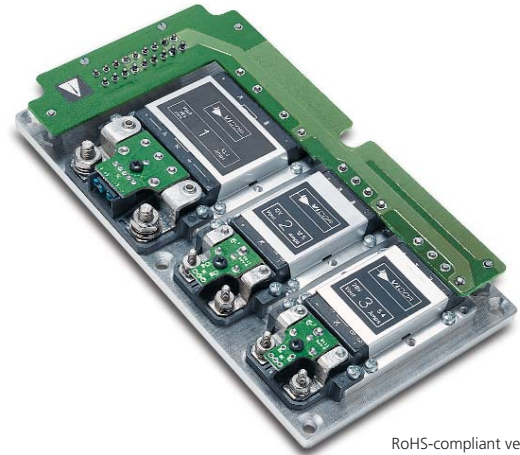

Features

- Input voltage: 24, 28, 48, 72, 110, 150, 300 or 375 V
- Booster versions for higher output current applications
- Agency approvals: cTUVus, CE Marked (300, 375 Vdc inputs only)

[MIL-COTS Version Available](#)

[Page 37](#)

RoHS-compliant versions can be selected with the VIPAC Design Tool.

[Configure Your VIPAC Array Power System Online](#)



[vicorpower.com/vcad](#)

Chassis Configurations Dimensions vary with specific model configurations



- 2 Minis**
- Single or dual outputs
 - Up to 600 W total
 - 3.62" x 6.69" x 0.78"^[a] (92,0 x 170,0 x 19,8 mm)

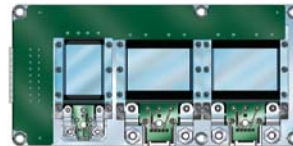

- 1 Micro, 2 Minis**
- Dual or triple outputs
 - Up to 750 W total
 - 3.62" x 7.52" x 0.78"^[a] (92,0 x 191,0 x 19,8 mm)



- 1 Mini, 2 Micros**
- Single, dual or triple outputs
 - Up to 600 W total
 - 3.62" x 6.69" x 0.78"^[a] (92,0 x 170,0 x 19,8 mm)

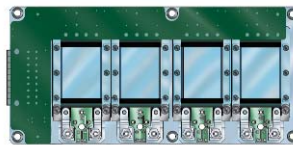

- 4 Micros**
- Dual, triple or quad outputs
 - Up to 600 W total
 - 3.62" x 7.52" x 0.76"^[a] (92,0 x 191,0 x 19,3 mm)



- 3 Micros**
- Dual or triple outputs
 - Up to 450 W total
 - 3.62" x 6.69" x 0.76"^[a] (92,0 x 170,0 x 19,3 mm)

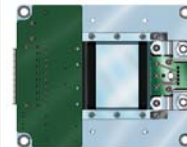

- 1 Mini**
- Single output
 - Up to 300 W
 - Current share option
 - 3.62" x 4.39" x 0.78"^[a] (92,0 x 112,0 x 19,8 mm)

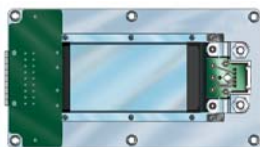

- 1 Maxi**
- Single output
 - Up to 600 W
 - Current share option
 - 3.62" x 6.69" x 0.78"^[a] (92,0 x 170,0 x 19,8 mm)



- 2 Micros**
- Single or dual outputs
 - Up to 300 W total
 - 3.62" x 4.39" x 0.78"^[a] (92,0 x 112,0 x 19,8 mm)

^[a] PlugMate version is 0.81" (20,5 mm) in height

DC-DC Configurable Power Supplies

Web ExpressCode: [compac](#)

ComPAC Family 50 – 600 Watt Input Power System

RoHS

ComPAC delivers up to 600 W from one, two, or three outputs in a package just 0.99" (25,2 mm) in height with the field proven performance, high efficiency and high reliability inherent in Vicor's component level power converters. ComPAC meets British Telecom and European Norms for input surge withstand and meets conducted emissions of EN55022, Class B. ComPAC is offered with input voltage ranges optimized for industrial and telecommunication applications and provides extended input overvoltage capability, input reverse polarity protection, undervoltage lockout, and master disable. ComPAC is available with [BatMod current source module](#), [Page 23](#).



Conduction-cooled models available

Features

- Inputs: 24, 48, and 300 Vdc
- Any output: 1 – 95 Vdc
- Agency approvals: cULus, cTUVus, CE Marked
- Efficiency: 80 – 90%
- Up to 10 W/in³
- EMI / RFI specifications: Telcordia TR-TSY-000513, British Telecom BTR 2511
- EN55022, Class B: Conducted emissions
- Input surge withstand: British Telecom BTR 2511, EN61000-4-5
- Low-noise ZCS / ZVS power topology
- Optional high-performance heat sink
- Finned or conduction-cooled package

[MIL-COTS Version Available](#)

[Page 37](#)

General Performance Refer to data sheet for specifications

Parameter	Designator	Rating	Unit
Input voltage range	1	21 – 32	Vdc
	W	18 – 36	Vdc
	3	42 – 60	Vdc
	N	36 – 76	Vdc
	6	200 – 400	Vdc
Outputs		1, 2 or 3	
Output power		50 – 600	Watts
Output voltage(s)		1 – 95	Vdc
Operating temperature (case)			
E-Grade		-10 to +85	°C
C-Grade		-25 to +85	°C
I-Grade		-40 to +85	°C
M-Grade		-55 to +85	°C

Chassis Configurations



- Single output
- 50 – 200 Watts
- 9.25" x 2.5" x 0.99" (234,8 x 63,5 x 25,2 mm)

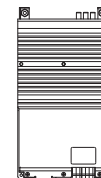

- Single or dual outputs
- 100 – 400 Watts
- 9.25" x 4.9" x 0.99" (234,8 x 124,5 x 25,2 mm)

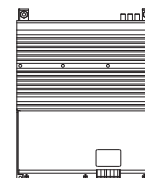

- Single, dual, or triple outputs
- 150 – 600 Watts
- 9.25" x 7.3" x 0.99" (234,8 x 185,4 x 25,2 mm)

Part Numbering

VI	-	N	C	3	4			-	C	M		
(VE) = RoHS Compliant		Family	Input	Out 1	Out 2 ^[a]	Out 3 ^[b]	Grade	Power 1	Power 2 ^[a]	Power 3 ^[b]		
		L = Single	1 = 24 V ^[c]	Z = 2 V	M = 10 V	K = 40 V	E = -10°C	M = 600 W	U = 200 W	U = 200 W		
		M = Single	W = 24 V	Y = 3.3 V	1 = 12 V	4 = 48 V	C = -25°C	P = 450 W	V = 150 W	V = 150 W		
		N = Single	3 = 48 V	0 = 5 V	P = 13.8 V	H = 52 V	I = -40°C	Q = 400 W	W = 100 W	W = 100 W		
		P = Dual	N = 48 V	X = 5.2 V	2 = 15 V	F = 72 V	M = -55°C	S = 300 W	X = 75 W	X = 75 W		
		Q = Dual	6 = 300 V	W = 5.5 V	N = 18.5 V	D = 85 V		U = 200 W	Y = 50 W	Y = 50 W		
		R = Triple		V = 5.8 V	3 = 24 V	B = 95 V		V = 150 W				
				T = 6.5 V	L = 28 V			W = 100 W				
				R = 7.5 V	J = 36 V			X = 75 W				
				All voltages available for output 1, 2, or 3				Y = 50 W				

^[a] For P, Q, R, PJ, and RJ only. Refer to output configuration chart.
^[b] For R and RJ only. Refer to output configuration chart.
^[c] Max output power / module 150 W.

Note: For conduction-cooled package add -CC to the part number. For example, VI-LWX-CV-CC.

DC-DC Configurable Power Supplies

Web ExpressCode: [megamod](#)

MegaMod Family Chassis-Mount VI-200 / VI-J00 Converters

RoHS

MegaMod and MegaMod Jr. DC-DC converters incorporate one, two, or three Vicor VI-200 or VI-J00 converters in a modular package to provide a chassis-mounted alternative to board-mounted power supplies. MegaMods offer 50 – 600 W of power from 1 – 3 outputs. MegaMod Jrs. offer a total of 25 – 300 W from 1 – 3 outputs. Each output may be independently sensed, adjusted, and sequenced using the procedures outlined for VI-200 and VI-J00 converters in the Vicor Applications Manual. [Download a PDF of the manual from the library section of vicorpower.com.](#)



[MIL-COTS Version Available](#)

[Page 37](#)

Features

- Inputs: 10 – 400 Vdc
- Any output: 1 – 95 Vdc
- Agency approvals: cULus, cTUVus, CE Marked
- Efficiency: 80 – 90% (typical)
- Up to 27 W/in³
- Low profile: 0.62" (15,7 mm) high
- Low noise ZCS / ZVS power topology
- Temperature grades (MegaMod Jr.):
E = –10 to +85°C (+100°C)
C = –25 to +85°C (+100°C)
I = –40 to +85°C (+100°C)
M = –55 to +85°C (+100°C)
- ZCS power architecture
- Booster versions available for expanded output power (MegaMod only)

Chassis Configurations

Input Selection

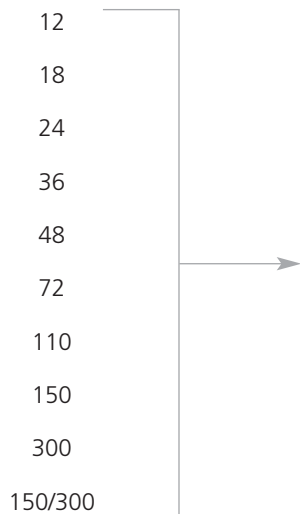

Package

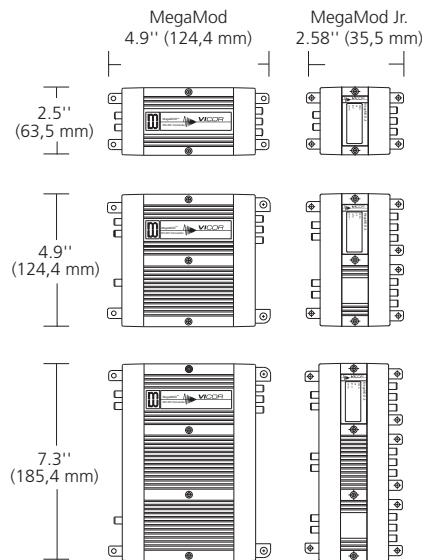

Output Power

- Single output
- 50 – 200 Watts — MegaMod: L
- 25 – 100 Watts — MegaMod Jr.: LJ
- Single or dual outputs
- 100 – 400 Watts — MegaMod: M, P
- 50 – 200 Watts — MegaMod Jr.: PJ
- Single, dual or triple outputs
- 100 – 600 Watts — MegaMod: N, Q, R
- 75 – 300 Watts — MegaMod Jr.: RJ

Part Numbering



(VE) = RoHS Compliant

Family	Input Voltage	Out 1	Out 2 ^[a]	Out 3 ^[b]	Grade	Power 1	Power 2 ^[a]	Power 3 ^[b]
L = Single	0 = 12 (10-20)	Z = 2 V	M = 10 V	K = 40 V	E = –10°C	M = 600 W	U = 200 W	U = 200 W
M = Single	V = 24 (10-36)	Y = 3.3 V	I = 12 V	4 = 48 V	C = –25°C	P = 450 W	V = 150 W	V = 150 W
N = Single	1 = 24 (21-32) ^[c]	0 = 5 V	P = 13.8 V	H = 52 V	I = –40°C	Q = 400 W	W = 100 W	W = 100 W
P = Dual	W = 24 (18-36)	X = 5.2 V	2 = 15 V	F = 72 V	M = –55°C	S = 300 W	X = 75 W	X = 75 W
Q = Dual	2 = 36 (21-56)	W = 5.5 V	N = 18.5 V	D = 85 V		U = 200 W	Y = 50 W	Y = 50 W
R = Triple	3 = 48 (42-60)	V = 5.8 V	3 = 24 V	B = 95 V		U = 150 W	Z = 25 W	Z = 25 W
LJ = Single	N = 48 (36-76)	T = 6.5 V	L = 28 V			V = 100 W		
PJ = Dual	4 = 72 (55-100)	R = 7.5 V	J = 36 V			X = 75 W		
RJ = Triple	T = 110 (66-160)					Y = 50 W		
	5 = 150 (100-200)					Z = 25 W		
	6 = 300 (200-400)							
	7 = 150 (100-375)							

All voltages available for output 1, 2, or 3

^[a] For P, Q, R, PJ, and RJ only. Refer to output configuration chart.

^[b] For R and RJ only. Refer to output configuration chart.

^[c] Max output power / module 150 W

MIL-COTS V•I Chips

Web ExpressCode: [mvichips](#)

DC-DC V•I Chip Modules 28 V Regulator, Voltage Transformer, & Bus Converter

VTMs put isolated current multiplication and voltage division directly at the point of load (POL), and an upstream PRM (Regulator) controls the factorized bus voltage supplied to the VTM to provide line and load regulation. Together, the PRM and VTM chip set provides the full functionality of a DC-DC converter, but with breakthrough performance and flexibility in a rugged, miniature package. The BCM (Bus Converter Module) functions as a fixed-ratio DC-DC transformer and provides an isolated bus voltage to power the PRM and VTM chip set or other loads.

The MIL-COTS PRM operates from a wide input range of 16 – 50 Vdc, meeting many of the ground vehicle and airborne requirements of MIL-STD-1275 and MIL-STD-704. Rated for 120 W, the 28 V PRM produces a nominal factorized bus voltage of 36 Vdc, controllable over the range of 26 – 50 Vdc. The downstream isolated VTM is available with twelve voltage division ratios from 1:1 to 1:32 and provides the user with flexibility to supply up to 100 A or 120 W at any output voltage from 1 – 50 Vdc in a surface-mount package occupying only 1 in². The MIL-COTS BCM is a high efficiency Sine Amplitude Converter (SAC) operating from a 240 to 330 Vdc primary bus to deliver an isolated 30 – 41.2 V nominal, unregulated secondary.



Features for PRM

- Input range: 16 – 50 Vdc
- 1.3 MHz switching frequency
- Efficiency: 95%
- -55°C to +125°C operation (Tj)
- ZVS buck-boost regulator

Features for VTM

- Isolated 1–50 Vdc output
- 1 μs transient response
- 3 MHz switching frequency
- Efficiency: Up to 96.5%
- -55 to +125°C operation (Tj)

Features for BCM

- Input range: 240 – 330 Vdc
- Output range: 30.0 – 41.2 Vdc
- MIL-STD-704E/F Compliant
- Efficiency: >95%
- -55 to +125°C operation (Tj)

MIL-COTS VI BRICKs PRM / VTM Thermally Enhanced Package

Web ExpressCode: [mvib](#)

The **PRM** Regulator Module is a very efficient non-isolated regulator specifically designed to provide a controlled Factorized Bus distribution voltage for powering downstream VI BRICK Voltage Transformation Modules. In combination, VI BRICK PRMs and VTMs form a complete DC-DC converter subsystem offering all of the unique benefits of Vicor's Factorized Power Architecture (FPA): high density and efficiency; low noise operation; architectural flexibility; extremely fast transient response; elimination of bulk capacitance at the point of load (POL); in a thermally enhanced package.



The thermally enhanced **VTM** voltage transformer excels at speed, density and efficiency to meet the demands of advanced power applications. Combined with the PRM regulator they create a DC-DC converter with flexibility to provide isolation and regulation where needed. The PRM can be located with the VTM at the point of load or remotely in the back plane or on a daughtercard.



MQPI-18 Input EMI Filter

The MQPI-18 is a surface mount DC front-end filter that provides EMI filtering for Vicor's 28 V DC-DC V•I Chip or VI BRICK modules. The MQPI-18 enables designers to meet conducted emission / conducted susceptibility per MIL-STD-461E. The MQPI-18 accepts an input voltage of 10 – 80 Vdc and delivers output current up to 7 A.



MIL-COTS Product Catalog

This document provides in-depth information on Vicor's line of MIL-COTS standard products, including DC-DC converters, custom solutions, and technical support.

- Environmental stress screening and MTBF
- Environmental qualification
- Custom configured modules
- Field tested... proven reliability

Visit vicorpower.com to view the Military Catalog online.

This will give you instant access to all technical documentation for a MIL-COTS product.



MIL-COTS BRICKs / Front ends

Web ExpressCode: **mbricks2**

Maxi, Mini & Micro Series DC-DC Converter Modules

These high-density DC-DC power converters are available in three rugged packages with output power up to 600 W. Standard inputs of 24, 28, 48, 72, 110, 150, 300, and 375 Vdc; and outputs from 1 – 48 Vdc, make these converters extremely flexible for MIL-COTS applications.

Features

- Inputs: 24, 48, 300, and 375 Vdc
NEW: 72, 110, 150, and wide input 28 Vdc
- Two operating temperature ratings:
–40 to +100°C and –55 to +100°C
- MIL-STD-810 and MIL-STD-202 qualified
- Environmental stress screening



Final test data available at
vicorquality.com



Web ExpressCode: **mbricks1**

MI-200 & MI-J00 Series DC-DC Converter Modules

Vicor's field-proven MIL-COTS power components have gained a reputation for quality and reliability among military power system designers. With thousands of standard models available, designers can rapidly meet performance, schedule, and budget objectives for just about any power solution.

Features

- Inputs per MIL-STD-704D/E/F: 28 and 270 Vdc
- Input per MIL-STD-1399A: 155 Vdc
- Output voltages: 2 – 48 Vdc
- Output power: 10 – 100 W
- MIL-STD-810 and MIL-STD-202 qualified
- NAVMAT component derating guidelines
- Power density: Up to 25 W/in³
- 75 and 100 W booster modules available



Web ExpressCode: **maim**

MI-AIM AC Front-end Module

The MI-AIM works in conjunction with Vicor's MI-x7x module family and is ideal for systems requiring AC rectification and transient protection.

Features

- 115 Vac nom, 60/400 Hz operation
- MIL-STD-461D EMI (CE102) @ 60 Hz
- MIL-STD-704A transient protection
- MIL-STD-810 and MIL-STD-202 qualified



MIL-COTS Filters

MicroRAM Output Ripple Attenuator Module

Web ExpressCode: [muram](#)

Vicor's MicroRAM output ripple attenuation module combines both active and passive filtering to achieve greater than 40 dB of noise attenuation from 60 Hz to 1 MHz. The MicroRAM operates over a range of 3 – 30 Vdc, is available in either 20 or 30 A models, and is compatible with all Vicor DC-DC converters.

Features

- >40 dB ripple attenuation from 60 Hz to 1 MHz
- 20 and 30 Amp ratings
- Operation: –55°C
- Input: 3 – 30 Vdc



M-FIAM Filter Input Attenuator Module

Web ExpressCode: [mfiam](#)

The M-FIAM is a DC front-end module that provides EMI filtering and transient protection. The M-FIAM3 and 5B enables designers using Vicor 24 and 300 V Maxi, Mini and Micro DC-DC converters to meet conducted emission / susceptibility per MIL-STD-461E and input transients per MIL-STD-704E/F. The M-FIAM7, compatible with 28 Vdc V•I Chip modules, and the M-FIAM9, compatible with Vicor's V24 and V28 DC-DC converters, are compliant to MIL-STD-461E, MIL-STD-704A-F, MIL-STD-1275A/B/D and DO-160E.

Features

M-FIAM3, M-FIAM5B & M-FIAM9

- MIL-STD-461E conducted emissions / susceptibility
- MIL-STD-704E/F transient protection
- MIL-STD-704A-F & MIL-STD-1275A/B/D transient protection (M-FIAM9)
- Compatible with 24, 28 & 300 Vdc input Maxi, Mini & Micro DC-DC converters

M-FIAM7

- MIL-STD-461E conducted emissions / susceptibility
- MIL-STD-704A-F, MIL-STD-1275A/B/D & DO-160E transient protection
- Compatible with 28 Vdc V•I Chip modules

MVA-FIAM5B & MVA-FIAM9

- Coldplate connector mounting option for M-FIAM5B and M-FIAM9



MI-IAM Input Attenuator Module

Web ExpressCode: [miam](#)

The MI-IAM provides EMI filtering to MIL-STD-461C/D/E and transient protection to the most severe levels of MIL-STD-704A-F, MIL-STD-1275A/B/D and DO-160E using MI-200 or MI-J00 DC-DC converters.

Features

- Input: 28 or 270 Vdc
- MIL-STD-704A-F, MIL-STD-1275A/B/D & DO-160E transient protection
- MIL-STD-461C/D/E conducted emissions / susceptibility
- MIL-STD-810 and MIL-STD-202 qualified
- Compatible with MI-200 and MI-J00 DC-DC converters



MIL-COTS Configurable Power Supplies

MI-MegaMod Family Chassis-Mount DC-DC Converter

Web ExpressCode: [mmega](#)

DC input power converters delivering up to 300 W from one, two, or three outputs in a package just 0.62" in height.

Features

- Standard inputs: 28, 155 & 270 Vdc
- Power density: Up to 13.5 W/in³
- Output voltages: 2 – 48 Vdc
- 1, 2 or 3 outputs: Up to 300 W



MI-CompAC DC-DC Configurable Power Supply

Web ExpressCode: [mcompac](#)

The MI-CompAC is a complete single, dual, or triple output DC-DC power supply that delivers up to 300 W from inputs of 28 or 270 Vdc.

Features

- Complete single, dual, or triple output power supply 50 – 300 W
- MIL-STD-461C/D/E conducted emissions / susceptibility
- MIL-STD-704A-F, MIL-STD-1275A/B/D & DO-160E transient protection
- Conduction-cooled models available



MIL-COTS VIPAC Arrays Chassis Mount DC-DC Converter

Web ExpressCode: [mvipacary](#)

VIPAC Arrays are a highly flexible input power systems that can be configured with up to four user-defined outputs, with power capability, up to 650 W.

Features

- Inputs: 24, 28 & 300 Vdc
- 55°C operation
- Configurable multi outputs; Up to 650 W
- MIL-STD-810F shock & vibration



28 Vdc MIL-COTS VIPAC DC-DC Configurable Power Supply

Web ExpressCode: [mvipac](#)

The 28 Vdc VIPAC can be specified with up to 3 outputs in a choice of connections with voltages as low as 3.3 Vdc to as high as 48 Vdc and power levels from 50 to 400 watts per output for MIL-COTS applications.

Features

- 28 Vdc input
- 55°C operation
- MIL-STD-704A-F and MIL-STD-1275A/B/D input transient protection
- Profile as low as 0.75 in. (19,0 mm)
- MIL-STD-461E EMI compliance
- MIL-STD-810F shock & vibration



VME450™ DC-DC Configurable Power Supply

Web ExpressCode: [vme450](#)

Powered with Vicor V•I Chips, this single-slot VME power supply is small, light weight and very efficient.

Features

- 28 Vdc input
- 4 output voltages, 550 W
- MIL-STD-704A-F and MIL-STD-1275A/B/D input transient protection
- 40°C to +85°C
- MIL-STD-461E EMI compliance



AC-DC Westcor Division Configurable Power Supplies

Web ExpressCode: [lopac](#)

LoPAC Family Switcher Power Supplies

RoHS

The LoPAC Family consists of three power supplies available as one-, two-, or three-slot packages. For maximum flexibility, they are configured with standard Vicor DC-DC converters. These modules cover the entire range of outputs from 2 – 95 Vdc (higher through series arrays) and 25 – 600 W per output, as well as an array of non-standard voltages. Depending on the configuration, the LoPACs can provide up to six user-specifiable isolated outputs.

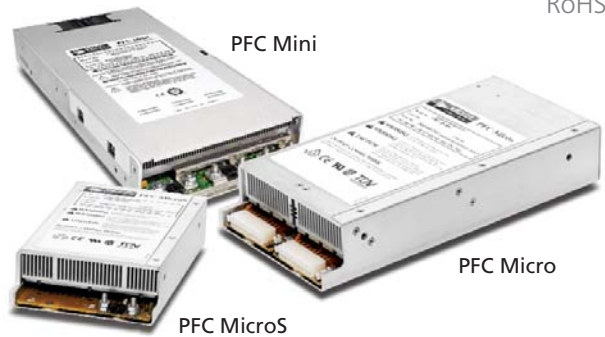

Features

- Near unity power factor
- Power factor corrected
- Output power: Up to 1,500 W
- Up to 6 user-specifiable outputs
- Power density: Up to 11 W/in³
- Fan cooled
- MIL-STD-810E-Vibration (PFC Mini)
- Agency approvals: UL, cTUVus, CE Marked
- Choice of full, half, or quarter brick

[LoPAC Family Accessories](#)

Page 52

[Configure Your LoPAC Online](#)



General Performance Refer to data sheet for detailed specifications

Product	Dimensions	Input Voltage	Number of Slots	Number of Outputs	Maximum Output Power @ 230 Vac	Maximum Output Power @ 115 V	Modules per Slot
PFC Mini	12.2" x 6" x 1.72" (309,9 x 152,4 x 43,6 mm)	85 – 264 Vac 100 – 380 Vdc	3	6	1,500 W	800 W	1 Full or 2 Half
PFC Micro	10.4" x 5.06" x 1.86" (264,1 x 128,5 x 47,3 mm)	85 – 264 Vac 100 – 300 Vdc	2	6	800 W	500 W	1 Full or 2 Half or 3 Quarter
PFC MicroS	7.95" x 5.06" x 1.86" (201,9 x 128,5 x 47,3 mm)	85 – 264 Vac 100 – 300 Vdc	1	3	600 W	500 W	1 Full or 2 Half or 3 Quarter

Note: For detailed information, review specific [product design guides available online at vicorpower.com](#)

Part Numbering Ordering, see back cover for contacts

P M	X₁	–	X₂	X₃	X₄	–	XXXX	–	X₅	–	X₆
Product Prefix PM = PFC Mini PC = PFC Micro PS = PFC MicroS	Number of Outputs 1 – 6		Number of VI-200 / VI-J00 Series Modules	Number of Maxi, Mini or Micro Series Modules	Optional Factory Assigned		Factory Assigned		Optional Factory Assigned 2 = FasTrak ^[a] G = RoHS		Optional Codes LL = Low Leakage ^[a] QF = Quiet Fan ^[a]

^[a] PFC Mini Only

Standard Single-Output Configurations

PFC Mini ^[b]	Vout	Amps	Watts	PFC Micro ^[c]	Vout	Amps	Watts	PFC MicroS ^[d]	Vout	Amps	Watts
PM1-03B-48-2	48	31.2	1,500	PC1-02B-48	48	16.7	800	PS1-01-48	48	12.5	600
PM1-03B-28-2	28	53.6	1,500	PC1-02B-28	28	28.6	800	PS1-01-28	28	21.4	600
PM1-03B-24-2	24	62.5	1,500	PC1-02B-24	24	33.3	800	PS1-01-24	24	25.0	600
PM1-03B-15-2	15	100	1,500	PC1-02B-15	15	53.3	800	PS1-01-15	15	40.0	600
PM1-03B-12-2	12	125.0	1,500	PC1-02B-12	12	66.7	800	PS1-01-12	12	50.0	600
PM1-03B-05-2	5	240.0	1,200	PC1-02B-05	5	160.0	800	PS1-01-05	5	80.0	400

^[b] Replace -2 with -G for RoHS compliant

^[c] Add -G to end of part number for RoHS compliant

^[d] Add -G to end of part number for RoHS compliant

VANTAGE Line – Westcor's Affordable Power Supply Option

Get the Westcor "advantage" of complete power supplies at a **15% discount**. Westcor's VANTAGE Line of power supplies was developed with all of the user configurability, field configurability, power density, and high efficiency that Westcor offers and with only minor specification changes. **Call a local Vicor Representative, or for your nearest Rep location go to vicorpower.com/company/contact_us**

FlatPAC-EN Power Supply

RoHS

The FlatPAC-EN is capable of providing up to 500 W (425 W for EN compliance) from up to four isolated outputs. The FlatPAC-EN can be configured with standard Vicor DC-DC converter modules. Like all other configurable power supplies offered by Vicor, the optimum FlatPAC-EN solution can be factory configured based on the exact voltage and power requirements of the customer.



[FlatPAC-EN Accessories](#)

[Page 52](#)



Features

- EN61000-3-2 harmonic current compliance
- Output power: Up to 500 W (425 W for EN compliance)
- Power density: >7 W/in³
- Ultra low profile: 1.4" (35,6 mm) height
- RS-232 microcontroller interface
- Rugged: Meets MIL-STD-810E, category 10 for vibration
- Agency approvals: UL, cTUVus, CE Marked
- Choice of full-, half- and quarter-brick modules with outputs from 2 – 95 Vdc and 25 – 500 watts, as well as an array of non-standard output voltages
- Conduction or convection cooled (same model)

General Performance Refer to data sheet for detailed specifications

Product	Dimensions	Input Voltage	Output Power	Number of Outputs
FlatPAC-EN	9.2" x 5.0" x 1.4" (233,7 x 127 x 35,6 mm)	90 – 132 / 180 – 264 Vac 250 – 380 Vdc	500 W (425 W for EN compliance)	1 – 4

Part Numbering Ordering, see back for phone numbers

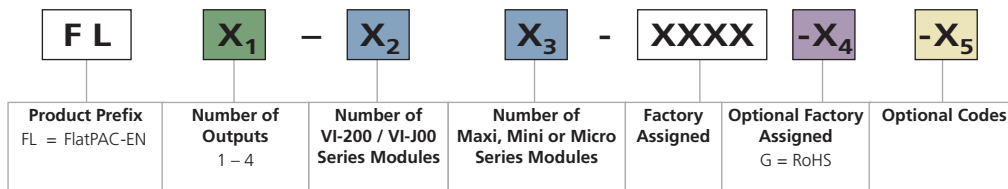

Configure Your
FlatPAC-EN Online
POWERBENCH
vicorpower.com/vspoc

Layout Configurations

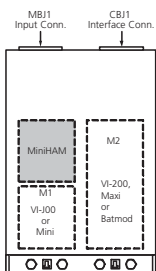

Single or Dual Outputs
Assumes either a full brick and / or half brick is used.

Stud Connectors
For a single output configuration, either M1 or M2 is used.

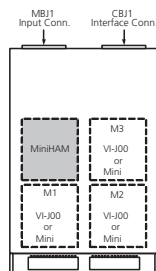

Triple Outputs
Assumes only half bricks are used.
Two 18-pin Molex Connectors.

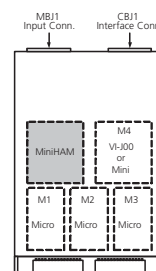

Quadruple Outputs
Assumes only half and / or quarter bricks are used. Two 18-pin Molex Connectors.

Note: The type of output connector a FlatPAC-EN has depends on which modules are used. For example, if a two output configuration uses two half bricks (instead of a full brick and half brick) this two output configuration will have the 18 pin Molex connectors, not stud connectors.

VANTAGE Line – Westcor’s Affordable Power Supply Option

Get the Westcor “advantage” of complete power supplies at a **15% discount**. Westcor’s VANTAGE Line of power supplies was developed with all of the user configurability, field configurability, power density, and high efficiency that Westcor offers and with only minor specification changes. *Call a local Vicor Representative, or for your nearest Rep location go to vicorpower.com/company/contact_us*

AC-DC Westcor Division Configurable Power Supply

Web ExpressCode: [megapac](#)

MegaPAC Family User & Field Configurable Power Supplies

RoHS

The MegaPAC family consists of eight fan-cooled, configurable power supplies that enable users to factory configure almost any set of output requirements by combining appropriate slide-in output assemblies called ConverterPACs, with the appropriate chassis. The MegaPAC chassis has a standardized feature-laden front end with slots to accept the ConverterPACs. Models are available with single or three-phase AC inputs. MegaPACs will also operate from high-voltage DC input. Features include EMI / RFI filtering, enable / disable, general shut down, output sequencing and AC OK.



Features

- Output power: 200 – 4,000 Watts
- User-configurable outputs
- Up to 20 outputs
- DC input capability
- Power factor corrected (some models)
- Low ripple 10 mV p-p or 0.15%, whichever is greater (some models)
- Fan cooled
- Efficiency: >80%
- Agency approvals: UL, cTÜVus, CE Marked
- Low leakage option available (some models)
- Current sharing available

[MegaPAC Family Accessories](#)

Page 52

[Configure Your MegaPAC Online](#)
POWERBENCH
vicorpower.com/vspoc

General Performance Refer to data sheet for detailed specifications

Product	Dimensions	Input Voltage	Output Power	# of Outputs	Slot Configurations
Mini MegaPAC	9.5" x 6.0" x 3.4" (241,3 x 152,4 x 86,4 mm)	90 – 132/180 – 264 Vac; Strappable 260 – 380 Vdc	1,000 W @ 115 Vac or 230 Vac	1 – 10 (5 slots)	ModuPAC, JrPAC, DualPAC, RAMPAC, BatPAC
Autoranging MegaPAC	11.9" x 6.0" x 3.4" (302,3 x 152,4 x 86,4 mm)	90 – 132/180 – 264 Vac 260 – 380 Vdc	1,200 W @ 115 Vac 1,600 W @ 230 Vac	1 – 16 (8 slots)	ModuPAC, JrPAC, DualPAC, RAMPAC, BatPAC
4 kW MegaPAC-EL	17.0" x 7.5" x 4.9" (431,8 x 190,5 x 124,5 mm)	208 or 240 Vac; 3-Phase 260 – 352 Vdc	2,000 W – 4,000 W, (3Ø) 1,500 W, (1Ø)	1 – 20 (10 slots)	QPAC, DualQPAC, JrQPAC, QPAC (XQ)
PFC MegaPAC/HP	12.3" x 6.0" x 3.4" (312,4 x 152,4 x 86,4 mm)	85 – 264 Vac 100 – 380 Vdc	1,200 W @ 115 Vac 2,400 W @ 230 Vac	1 – 13 (8 slots)	BatPAC, ModuPAC, JrPAC, DualPAC, RAMPAC, FinPAC
PFC MegaPAC-EL/HPEL	15.6" x 6.0" x 3.4" (396,2 x 152,4 x 86,4 mm)	85 – 264 Vac 100 – 380 Vdc	1,200 W @ 115 Vac 2,400 W @ 230 Vac	1 – 13 (8 slots)	QPAC, DualQPAC, JrQPAC, FinQPAC
4 kW MegaPAC	14.0" x 7.5" x 4.9" (355,6 x 190,5 x 124,5 mm)	208 or 240 Vac; 3-Phase 260 – 352 Vdc	2,000 W – 4,000 W, (3Ø) 1,500 W, (1Ø)	1 – 20 (10 slots)	ModuPAC, JrPAC, DualPAC, RAMPAC, BatPAC, UniPAC

Note: For detailed information, review specific [product design guides available online at vicorpower.com](#)

Part Numbering Ordering, see back cover for contacts

MP	X ₁	X ₂	X ₃	XXXX	-X ₄ X ₅	-X ₆	-X ₇
Product Prefix MP = Chassis using VI-200 / VI-J00 Series Modules only MX = Chassis using VI-200 / VI-J00 Series and / or Maxi Series Modules only MM = Chassis using VI-200 / VI-J00 Series Modules only (Strappable)	Number of Outputs 1 – 20	Chassis Type 1 = 115 – 230 Vac Strappable 4 = 3-Phase 7 = PFC 9 = Autoranging	Number of Modules	Factory Assigned	Optional Codes 4 kW MegaPAC and MegaPAC-EL only	Optional Codes 2 = FasTrak G = RoHS	Optional Codes EL = Extended Length LL = Low Leakage

VANTAGE Line – Westcor's Affordable Power Supply Option

Get the Westcor "advantage" of complete power supplies at a **15% discount**. Westcor's VANTAGE Line of power supplies was developed with all of the user configurability, field configurability, power density, and high efficiency that Westcor offers and with only minor specification changes. **Call a local Vicor Representative, or for your nearest Rep location go to vicorpower.com/company/contact-us**

AC-DC Westcor Division Configurable Power Supplies

Web ExpressCode: [cpacs](#)

ConverterPACs Output Power Up to 600 Watts

ConverterPACs incorporate VI-200 or VI-J00 and / or Maxi Vicor DC-DC converter bricks. For additional power, ConverterPACs can be paralleled. Some ConverterPACs are available for low-noise applications (VXI options, RamPACs and QPACs) and as current sources (BatPACs). All ConverterPACs can be easily removed in the field by loosening a single screw and sliding the unit out of the chassis.



Web ExpressCode: [cpacs1](#)

VI-200 / VI-J00 ConverterPACs ^[a] Output Power Up to 200 Watts

For general electrical specifications for VI-200 / VI-J00 ConverterPACs, see module specifications on the VI-200 / VI-J00 data sheets in the library section of our website.



ModuPAC (M)
Up to 200 W



JuniorPAC (J)
Up to 100 W



RamPAC (R)
Up to 100 W



BatPAC (B)
Up to 200 W
programmable current source



DualPAC (D)
Dual outputs:
Up to 100 W / output



QPAC (L)
Up to 200 W



DualQPAC (LD)
Up to 100 W / output



JrQPAC (LJ)
Up to 100 W

Maxi ConverterPACs ^[a] Output Power Up to 600 Watts

Web ExpressCode: [cpacs2](#)

For general electrical specifications for Maxi ConverterPACs, see module specifications on the data sheets in the library section of our website.



UniPAC (XU)
Up to 500 W



FinPAC (PZ)
Up to 600 W



QPAC (XQ)
Up to 500 W



FinPAC (PZL)
Up to 600 W

^[a] RoHS compliant ConverterPACs have a "G" added to their prefix (except the PZL where the RoHS version will be GPL).

Vicor CUSTOM

Web ExpressCode: [custom](#)

Custom Power Solutions Designed To Fit Your Specific Needs

Small company responsiveness, large company resources

The sole focus of Vicor Custom Power is designing and manufacturing turnkey custom power systems. Our custom power design centers maintain the flexibility of small entrepreneurial companies while taking advantage of Vicors technical and business resources to deal effectively with your most challenging power problems. Our total focus is on the power solution that best satisfies your needs.



Providing custom power solutions for:



COMMUNICATIONS



INDUSTRIAL



DATACOM



TEST EQUIPMENT

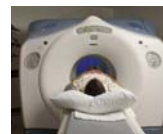

MEDICAL



MILITARY / AEROSPACE



TRANSPORTATION

Custom Power Design Centers:

Aegis Power Systems
Tel: 1 828 837 4029
email: aegis@aegispower.com
aegispower.com

ConverTec Corporation
Tel: 1 651 604 0289
email: eswanson@vicorpower.com

Freedom Power Systems
Tel: 1 512 259 0941
email: sales@freedompower.com
freedompower.com

Granite Power Technologies
Tel: 1 603 623 3222
granitepower.com

Mission Power Solutions
Tel: 1 760 631 6846
email: sales@mpwrs.com
mpwrs.com

Northwest Power Integrations
Tel: 1 503 652 6161
email: info@npi-inc.com
npi-inc.com

Locations: See our website page for complete details

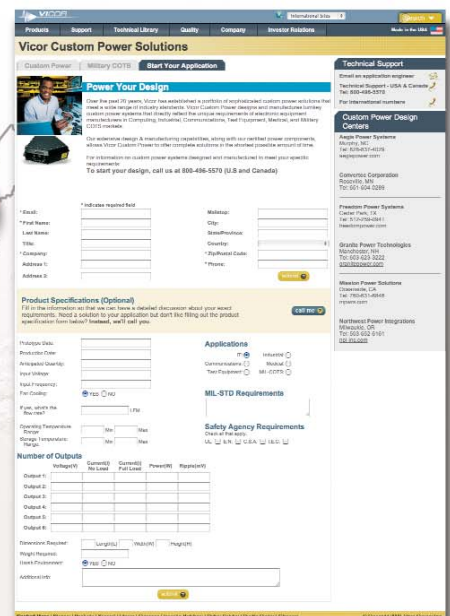
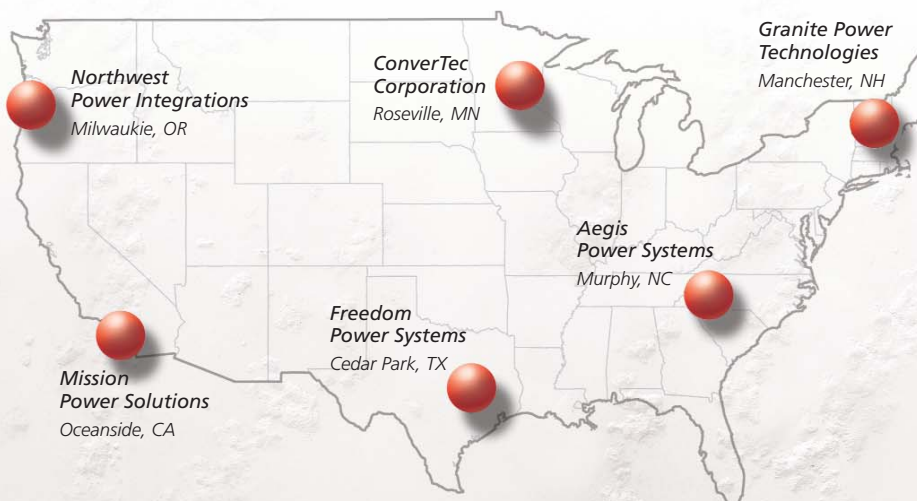

Vicor CUSTOM

Web ExpressCode: [custom](#)

Capabilities Overview

Vicor Custom Power has the capability to design, prototype, mass produce and certify a complete power system.

Design: Electrical and mechanical

Prototype: By utilizing Vicor's standard power components, delivery of prototype units can be very fast and in some cases, just a matter of weeks.

Mass production: Capacity to manufacture thousands of power systems per year.

Reliability / Certification: HALT (Highly Accelerated Life Test)
Temperature Cycling
Burn In
Thermal Shock
Humidity
Accelerated Life Test
Power Cycling
Vibration
EMI
Transient Immunity
Altitude
Explosive Atmosphere
Mechanical Shock
Acceleration

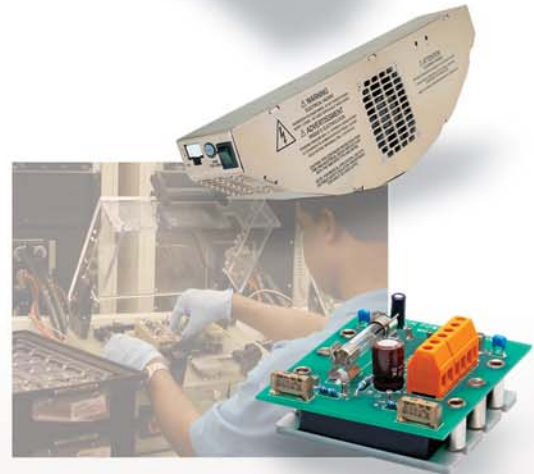
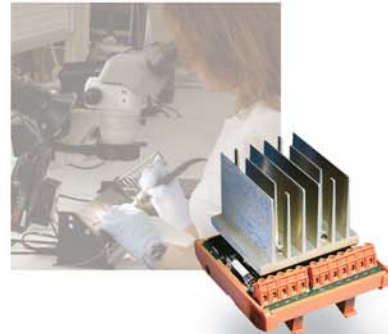

Vicor Custom Off-the-Shelf Configurable Power Supplies

Web ExpressCode: [vme450](#)

VME450™ From Aegis Power Systems

The single-slot VME450 power supply — filtered 28 Vdc, four output (3.3, 5, ±12 V), 550 W — is a MIL-COTS solution that is compliant to the vibration requirements of MIL-STD-810F and EMI per MIL-STD-461E. When compared to VME power supplies using conventional technology, the one-slot VME450 provides users with higher efficiency (85%), lower weight (2.4 pounds), and higher power (up to 550 W).

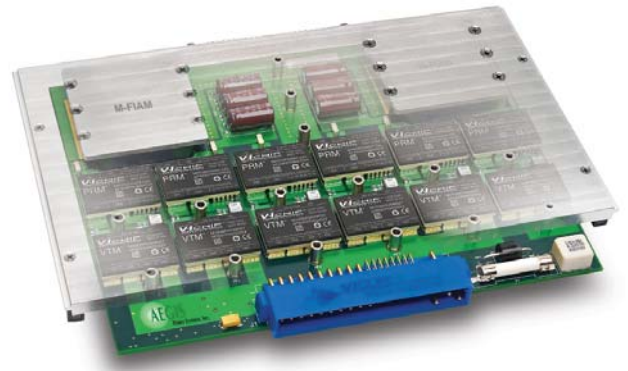

Features

- 28 Vdc per MIL-STD-704F
- 28 Vdc per MIL-STD-1275D
- Vin max range: 18 – 36 Vdc
- MIL-STD-461E conducted EMI
- Input power: 650 W
- Output power: 550 W
- 4 isolated outputs
- Temperature: –40 to +85°C
- Utilizes Vicor's V•I Chips
- Single slot VME

DC-DC MegaPAC™ From Mission Power Solutions

Web ExpressCode: [dcmegapac](#)

The DC MegaPAC allows users to instantly configure highly-efficient DC-DC power supplies. A complete power supply is configured by selecting and inserting up to eight slide-in output assemblies called "ConverterPACs". ConverterPACs incorporate one or two Vicor DC-DC converters and are available in a wide array of outputs and power levels. If output requirements change, the user can simply unlock a single screw and replace the slide-in ModuPAC assembly with one that has the desired rating.



Features

- DC inputs: 12 – 72 V available
- Output power: Up to 16 outputs and 1,600 W total power (depending upon input voltage)
- Temperature rating: Full power to 45°C; half power to 65°C
- Dimensions: 3.4" H x 6.0" W x 12.0" L (86,3 x 152,4 x 304,8 mm)
- 9.25 lbs. fully configured
- Fan cooled
- Soft start for limiting inrush current
- Conducted EMI meets BTR 2511
- Remote sense capability and output overcurrent protection on all outputs
- Output overvoltage protection on most outputs
- Output overtemperature protection on all outputs
- Input over, under and reverse voltage protection
- Box-to-box paralleling capability
- Input temperature monitor, warning and shut down
- CE Marked

Vicor Custom Off-the-Shelf Configurable Power Supplies

Web ExpressCode: [badger](#)

Badger™ From Mission Power Solutions

The Badger is a rugged PFC multi-output power supply, capable of withstanding extreme environments and stresses often inherent with military applications.



General Specifications Typical unless otherwise noted

Product	Dimensions	Input Voltage	Max # of Outputs	Maximum Power	Cooling	Notes
Badger	2.55" x 7.0" x 13.75" (64,8 x 177,8 x 349,3 mm)	85 – 264 Vac	12	1,800 W	Internal fans	OCP, OVP, and OTP on all outputs

Web ExpressCode: [javelin](#)

Javelin™ From Mission Power Solutions

The Javelin is an AC input power supply with a single DC output, capable of up to 5,400 W, in a rugged package suitable for industrial and military applications.



General Performance Refer to data sheet for detailed specifications

Product	Dimensions	Input Voltage	Max # of Outputs	Maximum Power	Cooling
Javelin I	4.9" x 7.0" x 10.75" (124,5 x 177,8 x 273,05 mm)	85 – 254 Vac	1	600 – 1,800 W	Internal fans
Javelin II	4.9" x 7.0" x 9.5" (124,5 x 177,8 x 241,3 mm)	85 – 254 Vac	1	600 – 1,800 W	No fan
Javelin III	7.0" x 16.0" x 13.0" (177,8 x 406,4 x 330,2 mm)	85 – 254 Vac 3-Phase	1	1,800 – 5,400 W	Internal fans

Web ExpressCode: [powerbank](#)

PowerBank™ From Northwest Power Integrations

The PowerBank is a low-profile AC-DC switching power supply that offers up to six configurable outputs at up to 1,500 Watts.



General Performance Refer to data sheet for detailed specifications

Product	Dimensions	Input Voltage	Max # of Outputs	Maximum Power	Cooling	Notes
PB1004PFC	1.74" x 8.08" x 10.28" (44,2 x 205,2 x 261,1 mm)	85 – 264 Vac	4	1,000 W	Internal fans	Low power stand-by output
PB1005AC	1.68" x 7" x 10.5" (42,7 x 177,8 x 266,7 mm)	115/230 Vac 300 Vdc	5	1,000 W	Internal fans	SEMI F47 compatible
PB1506PFC	1.75" x 12.6" x 16.84" (44,5 x 320,04 x 427,7 mm)	90 – 264 Vac	6	1,500 W	Internal fans	Two aux. low power outputs
PBC1002AC	2.5" x 7.38" x 9" (63,5 x 187,5 x 228,6 mm)	115/230 Vac	2	1,000 W	Cond., conv., liquid	Customizable baseplate / heat sink
PBC1002PFC	2" x 6.5" x 13.5" (50,8 x 165,1 x 342,9 mm)	90 – 264 Vac	2	1,000 W	Cond., conv., liquid	Customizable baseplate / heat sink

Evaluation Boards V-I Chip Products

V-I Chip BCM

Web ExpressCode: [bcmeb](#)

The BCM Evaluation Board has been designed to facilitate the verification of the V-I Chips superior performance in the areas of power density, efficiency (over a wide load range), fast response and quiet, low-noise operation. Adding the suffix "EB" to the BCM model number designates the Evaluation Board. For example the B048F120T30-EB specifies a 48 V to 12 V at 300 W BCM mounted to an Evaluation Board.



Example Number
B048F120T30-EB

RoHS

PRM & VTM

Web ExpressCode: [viceb](#)

The PRM and VTM Evaluation Boards allow the user to develop an understanding of Factorized Power Architecture (FPA™) using the PRM and VTM chip set. Simply select the PRM Evaluation Board to match your input voltage and VTM Evaluation Board to provide the desired output voltage and current and plug them together.

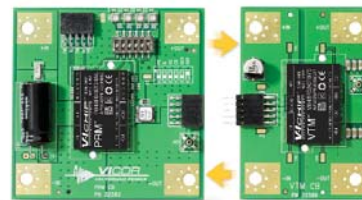

Example Number
P045F048T32AL-CB

Example Number
V048F040T050-CB

RoHS

High Voltage BCM

Web ExpressCode: [bcm pb](#)

The HV BCM Evaluation Board is used for powering, testing and evaluating the 380 Vdc input BCMs. The HV BCM Evaluation Board is available as a Parallel Array Board with a 12 Vdc, 100 A output or as a Series Array Board with a 48 Vdc 25 A and / or 12 Vdc, 25 A with up to 1,200 Watts total.



Parallel Array
Example Number
B384F120T30-PB

RoHS

PRM Constant Current Board

Web ExpressCode: [prmc](#)

The PRM Constant Current (CC) Demonstration Board is suitable for light-emitting diode (LED) applications such as street & stadium lighting, high-end projectors, active outdoor advertising and architectural installations. The board provides a precisely regulated current as required for direct drive multi-LED applications where the intensity and brightness are controlled by regulating the current through the LEDs.



Example Number
P048F048T24AL-CC

RoHS

Evaluation Boards DC-DC VI BRICK Products

VI BRICK

Web ExpressCode: [vibeb](#)

VI BRICK evaluation boards are available to verify the performance and simplify testing of VI BRICK modules. There are separate boards for the VI BRICK – PRM, VTM, BCM, and DC-DC converters.

Description

VI BRICK PRM evaluation board
 VI BRICK VTM evaluation board
 VI BRICK BCM evaluation board
 VI BRICK DC-DC evaluation board

Part Number

Add "-CB" suffix to the
 VI BRICK specific part #

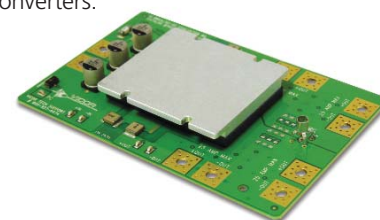

RoHS

Evaluation Boards DC-DC Brick / EMI Filters / Output Filters & Cool-ORing Products

Maxi, Mini & Micro

Web ExpressCode: **mmmeb**

- Three styles: Maxi, Mini or Micro
- Inboard and onboard compatible
- Easy I/O and control connections
- Includes fusing and capacitors
- Can be paralleled for higher power arrays

Description	Part Number
Maxi board style	24644R
Mini board style	24645R
Micro board style	24646R



RoHS

QPI Active EMI Filters & V•I Chip Optimized Filters

Web ExpressCode: **qpieb qpob**

The QPI / QPO filter evaluation boards provide a quick and easy way to evaluate the EMI / EMC performance of the filters with a broad range of DC-DC converters. Available QPI input EMI filter boards include: boards compatible with V•I Chip evaluation boards, DOSA pin-out compatible evaluation boards, and universal style use "EVAL1" evaluation boards. QPO output ripple attenuator boards are available in a universal "EVAL1" configuration or with sockets compatible with Vicor Mini and Micro DC-DC converters.

Part Number Description

- QPI-3-CB1^[a]QPI-3LZ for 24 V input DC-DC up to 7 A
- QPI-4-CB1^[a]QPI-4LZ for 48 V input DC-DC up to 7 A
- QPI-5-CB1^[a]QPI-5LZ for 24 V input DC-DC up to 14 A
- QPI-6-CB1^[a]QPI-6LZ for 48 V input DC-DC up to 14 A
- QPI-7-CB1^[a]QPI-7LZ for 24 V input DC-DC up to 6 A, *w/ integrated Hot-Swap*
- QPI-8-CB1^[a]QPI-8LZ for 48 V input DC-DC up to 6 A, *w/ integrated Hot-Swap*

^[a] The part numbers above are compatible with mounting DOSA compliant DC-DC converters. For universal plug in evaluation boards substitute CB1 with EVAL1.

QPI V•I Chip Optimized Filter Evaluation Boards

- QPI-9-CB1QPI-9LZ for 24 V input V•I Chips up to 6 A, *w/ integrated Hot-Swap*
- QPI-10-CB1QPI-10LZ for 48 V input V•I Chips up to 6 A, *w/ integrated Hot-Swap*
- QPI-11-CB1QPI-11LZ for 24 V input V•I Chips up to 7 A
- QPI-12-CB1QPI-12LZ for 48 V input V•I Chips up to 7 A

MQPI MIL COTS V•I Chip Optimized Filter Evaluation Board

- MQPI-18-CB1MQPI-18LP for 28 V input V•I Chips up to 7 A

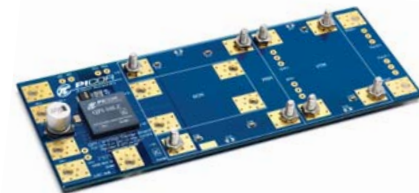

QPO Active Output Filters

Part Number Description

- QPO-1-EVAL1QPO-1LZ, 3 – 30 V input up to 10 A
- QPO-1-EVAL3QPO-1LZ, board with sockets for Vicor Mini DC-DC converter
- QPO-1-EVAL5QPO-1LZ, board with sockets for Vicor Micro DC-DC converter
- QPO-2-EVAL1QPO-2LZ, 0.5 – 5.5 V input up to 20 A



Web ExpressCode: **coreb**

Cool-ORing Discrete & Full-Function Active ORing Solutions

The Cool-ORing evaluation boards offer a quick and easy way for the user to complete functional testing of Picor's Cool-ORing solutions. These evaluation boards demonstrate solutions satisfying a range of Active ORing requirements, covering several typical redundant bus voltages. The user can chose to evaluate a discrete implementation or a high density integrated solution depending on system level requirements. The user can use the evaluation board to measure steady state efficiency as well as test dynamic performance of the Cool-ORing product under system level fault conditions.

Part Number Description

- PI2001-EVAL1 PI2001 using 3 x 3 mm TDFN package & SO-8 MOSFET in high-side configuration
- PI2002-EVAL1 PI2002 using 3 x 3mm TDFN package and back-to-back SO-8 MOSFETs in high-side configuration
- PI2003-EVAL1 PI2003 using 3 x 3 mm TDFN package and 100V SO-8 MOSFET in low-side configuration
- PI2121-EVAL1 PI2121 configured for a high-side ground referenced application
- PI2122-EVAL1 PI2122 Active ORing with load disconnect
- PI2125-EVAL2 PI2125 configured for a high-side floating application

NOTE: Both PI2121-EVAL1 and PI2125-EVAL2 are compatible with the PI2123 solution.

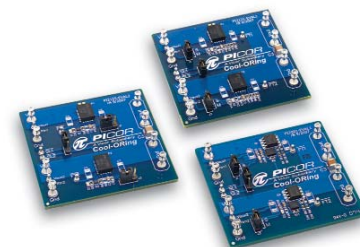















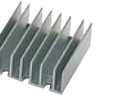



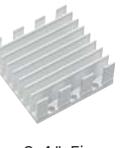

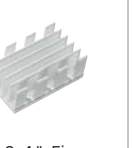

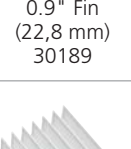

ACCESSORIES

Web ExpressCode: mounting1

Mounting & Thermal Management

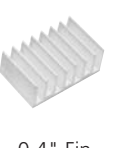
All parts are RoHS compliant unless otherwise noted

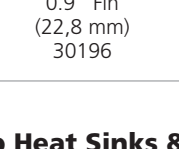
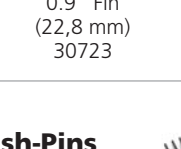
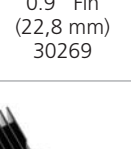
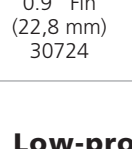
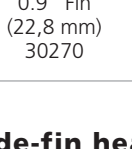
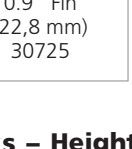
VI-200	Longitudinal Fins	Transverse Fins	Longitudinal Fins	Transverse Fins	Longitudinal Fins	Transverse Fins
	 0.90" Fin (22,8 mm) 30089	 0.90" Fin (22,8 mm) 30090	 0.70" Fin (17,7 mm) 30775	 0.70" Fin (17,7 mm) 30193	 1.45" Fin (36,8 mm) 30780	 0.40" Fin (10,1 mm) 30194
VI-100	Longitudinal Fins		Transverse Fins		Transverse Fins	
	 0.90" Fin (22,8 mm) 30191		 0.90" Fin (22,8 mm) 30771		 0.40" Fin (10,1 mm) 30140	
Longitudinal Fins	Maxi Heat Sinks		Mini Heat Sinks		Micro Heat Sinks	
	Threaded	Through Hole	Threaded	Through Hole	Threaded	Through Hole
	 0.4" Fin (10,1 mm) 30482	 0.4" Fin (10,1 mm) 30718	 0.4" Fin (10,1 mm) 32188	 0.4" Fin (10,1 mm) 30195	 0.4" Fin (10,1 mm) 32174	 0.4" Fin (10,1 mm) 30719
	 0.9" Fin (22,8 mm) 30188	 0.9" Fin (22,8 mm) 30181	 0.9" Fin (22,8 mm) 30189	 0.9" Fin (22,8 mm) 30182	 0.9" Fin (22,8 mm) 30190	 0.9" Fin (22,8 mm) 30183
Transverse Fins	 0.4" Fin (10,1 mm) 30778	 0.4" Fin (10,1 mm) 30720	 0.4" Fin (10,1 mm) 30184	 0.4" Fin (10,1 mm) 30721	 0.4" Fin (10,1 mm) 32173	 0.4" Fin (10,1 mm) 30722
	 0.9" Fin (22,8 mm) 30196	 0.9" Fin (22,8 mm) 30723	 0.9" Fin (22,8 mm) 30269	 0.9" Fin (22,8 mm) 30724	 0.9" Fin (22,8 mm) 30270	 0.9" Fin (22,8 mm) 30725

V•I Chip Heat Sinks & Push-Pins

For use with PRM, VTM and BCM V•I Chip Power Components



Heat Sink (includes thermal interface)	Part Number	Push-Pins (includes spring)	Part Number
Transverse Fins, 11 mm	32438	0.051" – 0.069" PCB	32434
Transverse Fins, 6.3 mm	32439	0.070" – 0.104" PCB	32435
Longitudinal Fins, 11 mm	32440	0.105" – 0.132" PCB	32436
Longitudinal Fins, 6.3 mm	32441	0.133" – 0.156" PCB	32437

Low-profile side-fin heat sinks – Height only 0.125" (3,1 mm) above module baseplate

0.55" (13,9 mm) Side Fins 30096
0.55" (13,9 mm) Side Fins 32190
0.55" (13,9 mm) Side Fins 30095



ACCESSORIES

Thermal Management

Web ExpressCode: mounting2

ThermMate™ Thermal Pads

For use with Vicor modules, ThermMate thermal pads are a "dry" alternative to thermal compound and are pre-cut to the outline dimensions of the module.

Thermal Pad	Part Number	Thickness
VI-200 (10 pc. pkg.)	20266	0.007" (0,17 mm)
VI-J00 (10 pc. pkg.)	20267	0.007" (0,17 mm)
Maxi (10 pc. pkg.)	20263	0.007" (0,17 mm)
Mini (10 pc. pkg.)	20264	0.007" (0,17 mm)
Micro (10 pc. pkg.)	20265	0.007" (0,17 mm)
VI BRICK – PRM / VTM / BCM Size "A" (10 pc. pkg.)	34636	0.007" (0,17 mm)
VI BRICK – DC-DC Converter Size "B" (10 pc. pkg.)	34637	0.007" (0,17 mm)

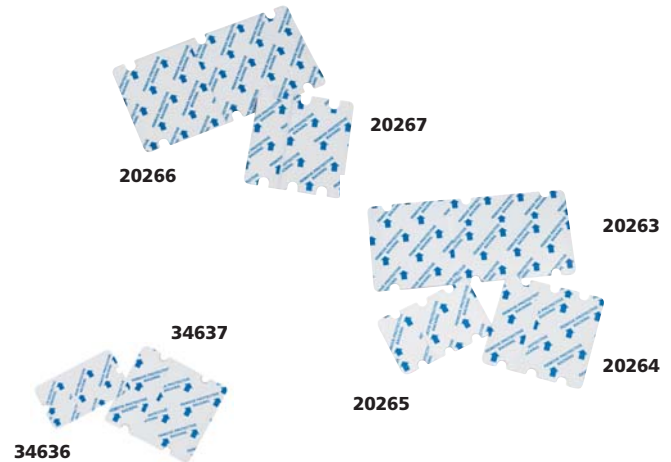

Grounding Clips

For use with FinMod and SlimMod packaging options (Page 23). Grounding clips provide a convenient means for making electrical connection between the heat sink assembly and the printed circuit board.

Use With...	Part Number
F1 and F2	32185
F3 and F4	32186
SlimMods	32187 ^[a]

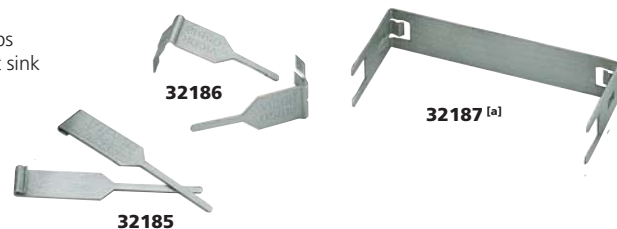

^[a] Not RoHS compliant

Mounting Standoffs

Web ExpressCode: standoffs

Module Standoffs

For mechanical mounting of VI-200 and VI-J00 Series modules. Also provides grounding of the module from the baseplate to the printed circuit board. (Sold individually)

Description	Part Number
0.525" (13,3 mm) Long	10692-01
0.25" (6,3 mm) Hex	



Standoffs and screws

Bulk and single-module kits compatible with all standard mounting configurations.



Sockets

Sockets are available for all Vicor VI-200 and VI-J00 modules and are intended for applications requiring ease of module installation or removal. Vicor modules have nine pins, seven of which are 0.040" and two are 0.080".

Pin Size	Finish	Part Number
0.040" (1,01 mm)	Electro-tin	30074
0.080" (2,03 mm)	Electro-tin	30075



VIEW MECHANICAL DRAWINGS ONLINE!
vicorpower.com



Minimum order quantities may apply.

ACCESSORIES

Web ExpressCode: sockets

ModuMate Socket Maxi, Mini & Micro Series

SurfMate: Surface Mount Sockets ^[a]

Board Thickness	Mounting Style	Full brick (Maxi)			Half brick (Mini)			Quarter brick (Micro)			Use module pin style ^[b]
		Input	Output	5 Sets	Input	Output	5 Sets	Input	Output	5 Sets	
All	Surface mount	22100	22101	16017	22100	22102	16021	22103	22104	16025	S, F

1. 

2. 

3. 

InMate: Through Hole Sockets ^[a]

All sockets are supplied on InMate headers to assure proper alignment during installation

Board Thickness	Mounting Style	Full brick (Maxi)			Half brick (Mini)			Quarter brick (Micro)			Use module pin style ^[b]
		Input	Output	5 Sets	Input	Output	5 Sets	Input	Output	5 Sets	
Nominal 0.062" (1,57 mm)	Inboard	18374	18382	18362	18374	18384	18366	18376	18386	18370	S, F
Min / Max 0.055" / 0.071" (1,3 mm) (1,8 mm)	Onboard	18378	18388	18364	18378	18390	18368	18380	18392	18372	N, G
Nominal 0.094" (2,38 mm)	Inboard	18375	18383	18363	18375	18385	18367	18377	18387	18371	S, F
Min / Max 0.084" / 0.104" (2,1 mm) (2,64 mm)	Onboard	18379	18389	18365	18379	18391	18369	18381	18393	18373	N, G
Nominal 0.125" (3,17 mm)	Onboard	21539	21543	21510	21539	21544	21511	21540	21545	21512	N, G
Min / Max 0.1125" / 0.1375" (2,85 mm) (3,5 mm)											

1. 

2. 

3. 

4. 

^[a] For individual input / output purchases, a 35-piece minimum (and multiples) applies to Maxis / Minis and a 40-piece minimum for Micros.

^[b] Page 15 for pin styles.

Module Exchange Tool

Used in facilitating the proper extraction of modules from InMate or SurfMate sockets.
Removal without using the Exchange Tool may cause damage to the sockets.

Description	Part Number
Maxi Exchange Tool	22827
Mini Exchange Tool	22828
Micro Exchange Tool	22829

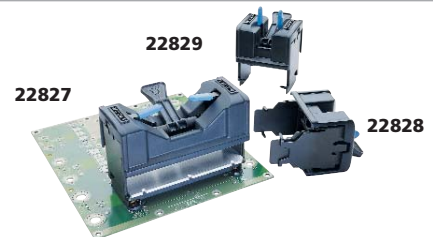

ACCESSORIES

Web ExpressCode: chokes

Magnetics

PR Bus Isolation Transformer Developed for isolation of PR Bus signal when used with Maxi, Mini, Micro parallel configurations. Consult Vicor for applications instructions.			Inductor, Differential Mode, Input																																			
																																						
Part Number 29768																																						
VI-HAM Line Filter The VI-HAM requires an external line filter. When used in conjunction with part number 30205, the VI-HAM / Filter combination will meet the requirements of worldwide EMI standards.			Inductors, Differential Mode Output inductors may be used to reduce differential output noise by approximately 20 dB.																																			
Part Number 30205																																						
Inductors, Common Mode These inductors provide a high level of attenuation of common-mode currents.			Common Mode Output Inductors																																			
<table border="1"> <thead> <tr> <th>Inductance / Winding</th> <th>DC Current / Resistance</th> <th>Part Number</th> </tr> </thead> <tbody> <tr> <td>1000 μH</td> <td>12 A / 6.5 mΩ</td> <td>31743</td> </tr> <tr> <td>3000 μH</td> <td>7 A / 18 mΩ</td> <td>31742</td> </tr> <tr> <td>2163 μH</td> <td>1 A / 42 m (low profile)</td> <td>31943</td> </tr> <tr> <td>1.3 mH</td> <td>13 A / 14 mΩ</td> <td>32006</td> </tr> </tbody> </table>			Inductance / Winding	DC Current / Resistance	Part Number	1000 μ H	12 A / 6.5 m Ω	31743	3000 μ H	7 A / 18 m Ω	31742	2163 μ H	1 A / 42 m (low profile)	31943	1.3 mH	13 A / 14 m Ω	32006	<table border="1"> <thead> <tr> <th>Inductance</th> <th>DC Current (max.)</th> <th>Part Number</th> </tr> </thead> <tbody> <tr> <td>420 μH</td> <td>20 A</td> <td>36-00037</td> </tr> <tr> <td>350 μH</td> <td>40 A</td> <td>36-00029-01</td> </tr> <tr> <td>1.27 mH</td> <td>10 A</td> <td>36-00029-04</td> </tr> <tr> <td>70 μH</td> <td>80 A</td> <td>36-00029-06</td> </tr> <tr> <td>110 μH</td> <td>60 A</td> <td>36-00029-07</td> </tr> </tbody> </table>			Inductance	DC Current (max.)	Part Number	420 μ H	20 A	36-00037	350 μ H	40 A	36-00029-01	1.27 mH	10 A	36-00029-04	70 μ H	80 A	36-00029-06	110 μ H	60 A	36-00029-07
Inductance / Winding	DC Current / Resistance	Part Number																																				
1000 μ H	12 A / 6.5 m Ω	31743																																				
3000 μ H	7 A / 18 m Ω	31742																																				
2163 μ H	1 A / 42 m (low profile)	31943																																				
1.3 mH	13 A / 14 m Ω	32006																																				
Inductance	DC Current (max.)	Part Number																																				
420 μ H	20 A	36-00037																																				
350 μ H	40 A	36-00029-01																																				
1.27 mH	10 A	36-00029-04																																				
70 μ H	80 A	36-00029-06																																				
110 μ H	60 A	36-00029-07																																				
Inductor, Output Sense Compensation																																						
<table border="1"> <thead> <tr> <th>Inductance</th> <th>Part Number</th> </tr> </thead> <tbody> <tr> <td>1 mH</td> <td>36-00030 ^[a]</td> </tr> </tbody> </table>			Inductance	Part Number	1 mH	36-00030 ^[a]																																
Inductance	Part Number																																					
1 mH	36-00030 ^[a]																																					

^[a] Not RoHS compliant

Web ExpressCode: caps

Capacitors

Capacitors, X-type For filtering specifications of FCC Level A.																				
<table border="1"> <thead> <tr> <th>Description</th> <th>Part Number</th> </tr> </thead> <tbody> <tr> <td>"X" Cap., 0.68 μF</td> <td>11217</td> </tr> <tr> <td>"X" Cap., 0.47 μF</td> <td>03047</td> </tr> <tr> <td>"X" Cap., 0.33 μF</td> <td>00927</td> </tr> <tr> <td>"X" Cap., 0.22 μF</td> <td>04068</td> </tr> <tr> <td>"X" Cap., 0.15 μF</td> <td>03269</td> </tr> <tr> <td>"X" Cap., 1.0 μF</td> <td>02573</td> </tr> </tbody> </table>			Description	Part Number	"X" Cap., 0.68 μ F	11217	"X" Cap., 0.47 μ F	03047	"X" Cap., 0.33 μ F	00927	"X" Cap., 0.22 μ F	04068	"X" Cap., 0.15 μ F	03269	"X" Cap., 1.0 μ F	02573				
Description	Part Number																			
"X" Cap., 0.68 μ F	11217																			
"X" Cap., 0.47 μ F	03047																			
"X" Cap., 0.33 μ F	00927																			
"X" Cap., 0.22 μ F	04068																			
"X" Cap., 0.15 μ F	03269																			
"X" Cap., 1.0 μ F	02573																			
Capacitors, Y-type For EMI / RFI considerations.																				
<table border="1"> <thead> <tr> <th>Description</th> <th>Part Number</th> </tr> </thead> <tbody> <tr> <td>"Y" Cap., 1,500 pF</td> <td>00770</td> </tr> <tr> <td>"Y" Cap., 4,700 pF</td> <td>01000</td> </tr> <tr> <td>"Y" Cap., 0.01 μF</td> <td>01501</td> </tr> <tr> <td>"Y" Cap., 0.022 μF</td> <td>03093</td> </tr> <tr> <td>"Y" Cap., 4,700 pF SMT version</td> <td>25283</td> </tr> <tr> <td>"Y" Cap., 1,500 pF SMT version</td> <td>30802</td> </tr> </tbody> </table>			Description	Part Number	"Y" Cap., 1,500 pF	00770	"Y" Cap., 4,700 pF	01000	"Y" Cap., 0.01 μ F	01501	"Y" Cap., 0.022 μ F	03093	"Y" Cap., 4,700 pF SMT version	25283	"Y" Cap., 1,500 pF SMT version	30802				
Description	Part Number																			
"Y" Cap., 1,500 pF	00770																			
"Y" Cap., 4,700 pF	01000																			
"Y" Cap., 0.01 μ F	01501																			
"Y" Cap., 0.022 μ F	03093																			
"Y" Cap., 4,700 pF SMT version	25283																			
"Y" Cap., 1,500 pF SMT version	30802																			
Capacitors, Hold up																				
<table border="1"> <thead> <tr> <th>Product</th> <th>Description</th> <th>Part Number</th> </tr> </thead> <tbody> <tr> <td>VI-AIM</td> <td>270 μF, 200 V</td> <td>30769</td> </tr> <tr> <td></td> <td>270 μF, 400 V</td> <td>30240</td> </tr> <tr> <td>VI-HAM</td> <td>470 μF, 450 V</td> <td>30249</td> </tr> <tr> <td>FARM / ARM</td> <td>1,200 μF, 200 V</td> <td>30275</td> </tr> <tr> <td></td> <td>2,200 μF, 200 V</td> <td>30483</td> </tr> </tbody> </table>			Product	Description	Part Number	VI-AIM	270 μ F, 200 V	30769		270 μ F, 400 V	30240	VI-HAM	470 μ F, 450 V	30249	FARM / ARM	1,200 μ F, 200 V	30275		2,200 μ F, 200 V	30483
Product	Description	Part Number																		
VI-AIM	270 μ F, 200 V	30769																		
	270 μ F, 400 V	30240																		
VI-HAM	470 μ F, 450 V	30249																		
FARM / ARM	1,200 μ F, 200 V	30275																		
	2,200 μ F, 200 V	30483																		

Minimum order quantities may apply.

Components

Web ExpressCode: comp

MOVs For use with front-end modules.														
<table border="1"> <thead> <tr> <th>Description</th> <th>Part Number</th> </tr> </thead> <tbody> <tr> <td>275 V MOV, 14 mm Disc</td> <td>30076</td> </tr> <tr> <td>68 V MOV, 10 mm Disc</td> <td>30234-068</td> </tr> <tr> <td>120 V MOV, 10 mm Disc</td> <td>30234-120</td> </tr> <tr> <td>200 V MOV, 10 mm Disc</td> <td>30234-200</td> </tr> <tr> <td>220 V MOV, 10 mm Disc</td> <td>30234-220</td> </tr> </tbody> </table>			Description	Part Number	275 V MOV, 14 mm Disc	30076	68 V MOV, 10 mm Disc	30234-068	120 V MOV, 10 mm Disc	30234-120	200 V MOV, 10 mm Disc	30234-200	220 V MOV, 10 mm Disc	30234-220
Description	Part Number													
275 V MOV, 14 mm Disc	30076													
68 V MOV, 10 mm Disc	30234-068													
120 V MOV, 10 mm Disc	30234-120													
200 V MOV, 10 mm Disc	30234-200													
220 V MOV, 10 mm Disc	30234-220													
Gas Discharge Tube For use with the ENMods and VI-ARM.														
<table border="1"> <thead> <tr> <th>Part Number</th> <th>Spark Over (DC)</th> </tr> </thead> <tbody> <tr> <td>13755</td> <td>220 V</td> </tr> <tr> <td>26107</td> <td>75 V</td> </tr> </tbody> </table>			Part Number	Spark Over (DC)	13755	220 V	26107	75 V						
Part Number	Spark Over (DC)													
13755	220 V													
26107	75 V													
														

VIEW MECHANICAL DRAWINGS ONLINE!
vicorpower.com



ACCESSORIES

Connector Kits FlatPAC, FlatPAC-EN, LoPAC, MegaPAC & PFC FrontEnd products

Web ExpressCode: **connects**

All parts are RoHS compliant unless otherwise noted

<p>FlatPAC Accessories</p> <p>Input and Output Retrofit Kits</p> <table border="0"> <thead> <tr> <th>Description</th> <th>Part Number</th> </tr> </thead> <tbody> <tr> <td>Input connector</td> <td>14136 ^[a]</td> </tr> <tr> <td>Output connector</td> <td>14137 ^[a]</td> </tr> </tbody> </table> <p>Input and Output Mating Connectors</p> <table border="0"> <thead> <tr> <th>Description</th> <th>Part Number</th> </tr> </thead> <tbody> <tr> <td>Input connector, 6 pin ^[b]</td> <td>33100</td> </tr> <tr> <td>Output connector, 5 pin ^[b]</td> <td>16385 ^[a]</td> </tr> </tbody> </table> <p><small>^[a] Not RoHS compliant ^[b] Insertion tool for use with FlatPAC input / output connectors are available from AMP, Inc., part number 58074-1. Manual hand tool, part number 58246-1, interchangeable head.</small></p>	Description	Part Number	Input connector	14136 ^[a]	Output connector	14137 ^[a]	Description	Part Number	Input connector, 6 pin ^[b]	33100	Output connector, 5 pin ^[b]	16385 ^[a]	<p>MegaPAC Accessories</p> <p>Connector Kits</p> <table border="0"> <thead> <tr> <th>Description</th> <th>Part Number</th> </tr> </thead> <tbody> <tr> <td>Single-phase input</td> <td>19-130040</td> </tr> <tr> <td>Three-phase input</td> <td>19-130041</td> </tr> <tr> <td>DualPAC / Dual QPAC output ConverterPacs</td> <td>19-130042</td> </tr> <tr> <td>Air block</td> <td>96-00032-01</td> </tr> </tbody> </table> <p>Current Share Boards</p> <table border="0"> <thead> <tr> <th>Description</th> <th>Part Number</th> </tr> </thead> <tbody> <tr> <td>MegaPACs using VI-200 and VI-J00 Series modules</td> <td>CSB01</td> </tr> <tr> <td>MegaPAC using Maxi modules</td> <td>CSB02</td> </tr> </tbody> </table> <p><i>MegaPAC chassis and ConverterPACs can be purchased separately for scalable systems and / or spares.</i></p> <p>Bus Bars</p> <table border="0"> <thead> <tr> <th>Description</th> <th>Part Number</th> </tr> </thead> <tbody> <tr> <td>2 holes</td> <td>88-00033-01</td> </tr> <tr> <td>3 holes</td> <td>88-00033-02</td> </tr> <tr> <td>4 holes</td> <td>88-00033-03</td> </tr> <tr> <td>5 holes</td> <td>88-00033-04</td> </tr> <tr> <td>Series bus bar</td> <td>88-00043</td> </tr> </tbody> </table>	Description	Part Number	Single-phase input	19-130040	Three-phase input	19-130041	DualPAC / Dual QPAC output ConverterPacs	19-130042	Air block	96-00032-01	Description	Part Number	MegaPACs using VI-200 and VI-J00 Series modules	CSB01	MegaPAC using Maxi modules	CSB02	Description	Part Number	2 holes	88-00033-01	3 holes	88-00033-02	4 holes	88-00033-03	5 holes	88-00033-04	Series bus bar	88-00043
Description	Part Number																																								
Input connector	14136 ^[a]																																								
Output connector	14137 ^[a]																																								
Description	Part Number																																								
Input connector, 6 pin ^[b]	33100																																								
Output connector, 5 pin ^[b]	16385 ^[a]																																								
Description	Part Number																																								
Single-phase input	19-130040																																								
Three-phase input	19-130041																																								
DualPAC / Dual QPAC output ConverterPacs	19-130042																																								
Air block	96-00032-01																																								
Description	Part Number																																								
MegaPACs using VI-200 and VI-J00 Series modules	CSB01																																								
MegaPAC using Maxi modules	CSB02																																								
Description	Part Number																																								
2 holes	88-00033-01																																								
3 holes	88-00033-02																																								
4 holes	88-00033-03																																								
5 holes	88-00033-04																																								
Series bus bar	88-00043																																								
<p>LoPAC Accessories</p> <p>Connector Kits</p> <table border="0"> <thead> <tr> <th>Description</th> <th>Part Number</th> </tr> </thead> <tbody> <tr> <td>PFC Mini</td> <td>19-130047</td> </tr> <tr> <td>PFC Micro, PFC MicroS</td> <td>19-130044</td> </tr> </tbody> </table> <p>Current Share Boards</p> <table border="0"> <thead> <tr> <th>Description</th> <th>Part Number</th> </tr> </thead> <tbody> <tr> <td>LoPACs using VI-200 and VI-J00 Series modules</td> <td>CSB01</td> </tr> <tr> <td>LoPACs using Maxi, Mini and Micro Series modules</td> <td>CSB02</td> </tr> </tbody> </table>	Description	Part Number	PFC Mini	19-130047	PFC Micro, PFC MicroS	19-130044	Description	Part Number	LoPACs using VI-200 and VI-J00 Series modules	CSB01	LoPACs using Maxi, Mini and Micro Series modules	CSB02	<p>FlatPAC-EN Accessories</p> <p>Connector Kit</p> <table border="0"> <thead> <tr> <th>Description</th> <th>Part Number</th> </tr> </thead> <tbody> <tr> <td>FlatPAC-EN</td> <td>19-130044</td> </tr> </tbody> </table> <p>Current Share Boards</p> <table border="0"> <tbody> <tr> <td>FlatPAC-EN using VI-200 and VI-J00 Series modules</td> <td>CSB01</td> </tr> <tr> <td>FlatPAC-EN using Maxi, Mini and Micro Series modules</td> <td>CSB02</td> </tr> </tbody> </table>	Description	Part Number	FlatPAC-EN	19-130044	FlatPAC-EN using VI-200 and VI-J00 Series modules	CSB01	FlatPAC-EN using Maxi, Mini and Micro Series modules	CSB02																				
Description	Part Number																																								
PFC Mini	19-130047																																								
PFC Micro, PFC MicroS	19-130044																																								
Description	Part Number																																								
LoPACs using VI-200 and VI-J00 Series modules	CSB01																																								
LoPACs using Maxi, Mini and Micro Series modules	CSB02																																								
Description	Part Number																																								
FlatPAC-EN	19-130044																																								
FlatPAC-EN using VI-200 and VI-J00 Series modules	CSB01																																								
FlatPAC-EN using Maxi, Mini and Micro Series modules	CSB02																																								
<p>PFC FrontEnd Accessories</p> <table border="0"> <thead> <tr> <th>Description</th> <th>Part Number</th> </tr> </thead> <tbody> <tr> <td>Din Rail Mounting Kit</td> <td>19-130060</td> </tr> <tr> <td>Connector Kit</td> <td>19-130059</td> </tr> <tr> <td>VIPAC Array Adapter</td> <td>19-130064</td> </tr> </tbody> </table>	Description	Part Number	Din Rail Mounting Kit	19-130060	Connector Kit	19-130059	VIPAC Array Adapter	19-130064																																	
Description	Part Number																																								
Din Rail Mounting Kit	19-130060																																								
Connector Kit	19-130059																																								
VIPAC Array Adapter	19-130064																																								

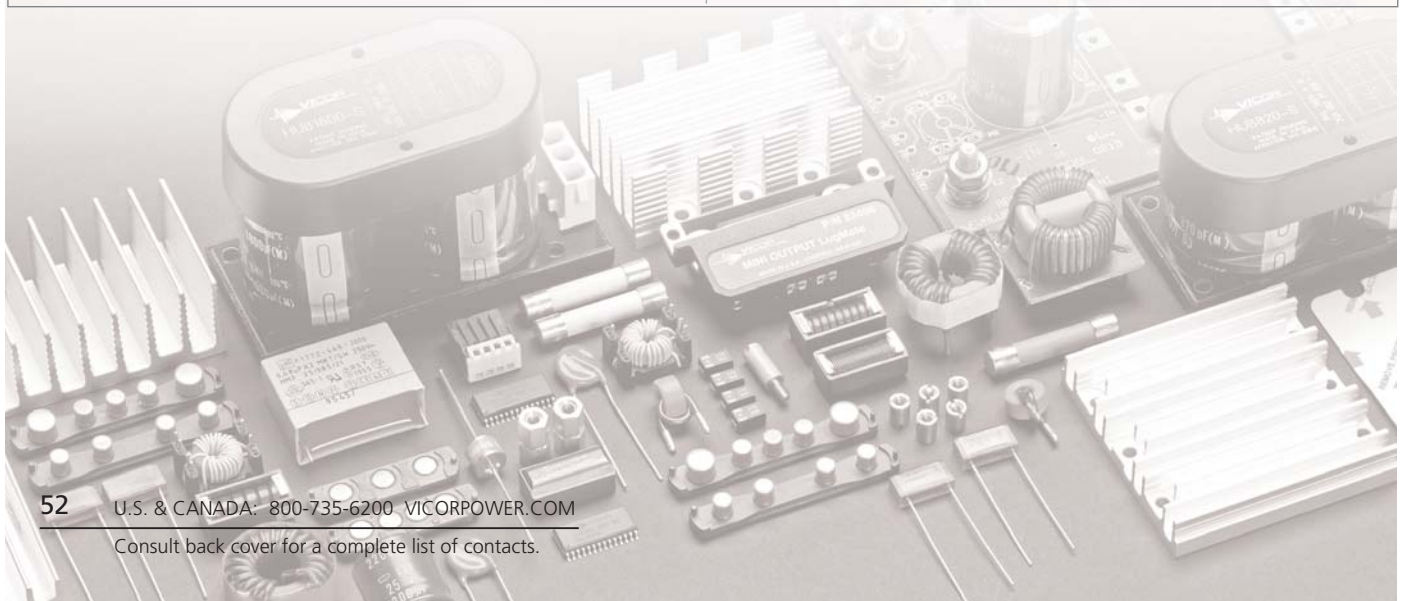

Quality System

We use the "Plan-Do-Check-Act" model (PDCA) to foster continuous improvement. We focus on key performance metrics that are continuously measured and reviewed. This enables us to be proactive in improving our technology, our products, our processes, and our service to our customers.

Browse

Vicor's Quality Process

Create

Custom Quality Reports

Download

Standard Quality Reports

Customize and Create a Report 

Quality Center Online

- Explore Vicor's quality systems through a robust library of documentation, videos, and process charts.
- Generate a report based on ISO 9001:2000 criteria that entirely meets your specific requirements.
- Get your report in PDF format with hyperlinks to videos and other information of your choosing.

Quality Library See and hear quality systems at work

- White papers on specific quality issues
- ISO 9001:2000 certificates
- RoHS compliant information
- Contact our quality team

Experience Vicor's Quality Center

vicorquality.com

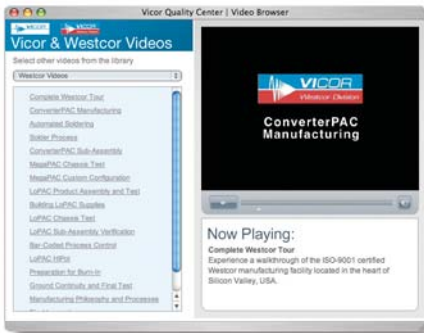

Play Video >



Play Video >>



Play Video >>



Play Video >>



Play Video >>



Play Video >



Play Video >>



Play Video >>



Play Video >>



Play Video >>

RoHS Technical Information

RoHS Compliance

Web ExpressCode: **rohs**



Vicor Corporation has a strong commitment to protecting our environment. As an ISO 9001:2000 registered company and a member of the global community, we are dedicated to meeting government regulations, international standards, and our customers' requirements. To those ends, we have developed and currently maintain Environmental Management Systems (EMS) and the requisite controlled business, design, and manufacturing processes to service our worldwide customer base.

ISO 9001:2000 Certified

Vicor is dedicated to developing and maintaining design and manufacturing processes to competitively service our world-wide customer base that meet government regulations, international standards, and our customers requirements.



VICORPOWER.COM

Use the Power of the Web

Develop your power solution by going to vicorpower.com. It's one of the premiere power-conversion sites on the web. Vicorpower.com is especially designed to get you the information you need quickly. And, through Vicor's unique mass-customization capabilities, we can provide you with exactly the power specifications you want at a price that's always affordable. Whether it's converters, user-configurable or custom power, Vicor has the high-value solution.

Here's what you'll find on vicorpower.com

- Design Guides and Application Notes
- Data sheets and mechanical drawings for all Vicor products
- PowerBench product configurators and a converter simulator that specifically analyzes your best options
- Technical seminars with synchronized video, PowerPoint, and access to related resources
- Webcasts on technical subjects of interest
- Application demonstrations
- Online Product & Military catalog with direct links to product pages, data sheets, and mechanical drawings
- Dedicated quality site with detailed factory tour and a custom quality report generator
- Technical articles that cover a huge range of applications challenges

vicorpower.com

Experience one of the premiere power conversion sites on the web

Feel free to contact Applications for any technical questions you may have at 1-800-927-9474 or Customer Service for price and delivery at 1-800-735-6200. For all other phone numbers, please consult back cover.

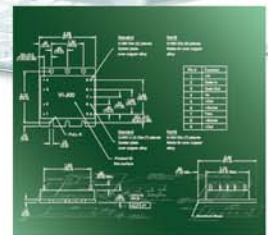

MECHANICAL DRAWINGS



DATA SHEETS



VIDEOS



CONFIGURATORS



QUALITY CENTER

Do-It-Yourself Power Design Custom Design Systems

Design your own DC-DC converter or configurable power supply – online – anytime using Vicor's custom configurators. Designs that you create are saved in your "My Designs" account for future review and editing. You register only once to access all Vicor's custom configurators via the "Single Sign-On" feature.

With Vicor's PowerBench **Custom Module Design System** you can design your own DC-DC converters using our proprietary simulator or using hundreds of predefined designs. You simply specify design parameters such as input voltage range, output voltage set point, output power, packaging, and environmental options. A true expert system, our Custom Module Design System generates a variety of valid designs, ranks them all, and selects the optimum one. A unique part number, unit price, and delivery schedule will be returned to you. You can even order online.

PowerBench's **VCAD™** is a patented system that enables users to specify online, the design of Vicor's VIPAC family from available input voltages, output configuration, thermal features, mechanical configurations, and an optional power up / power down sequencing feature.

PowerBench's **VSPOC™** enables the registered user to specify and verify complete AC-DC power supplies in real time. The system is fully integrated with Westcor manufacturing operations. Once the user approves the product configuration, a bill of materials is generated and an order can be placed immediately.

Vicor is committed to meeting designers' needs via mass customization. All our manufacturing facilities have this capability. We'll support you with the best applications group in the industry. Thousands of designers worldwide have taken advantage of custom Vicor DC-DC converters and power supplies designs. **You can, too.**



SINGLE SIGN-ON

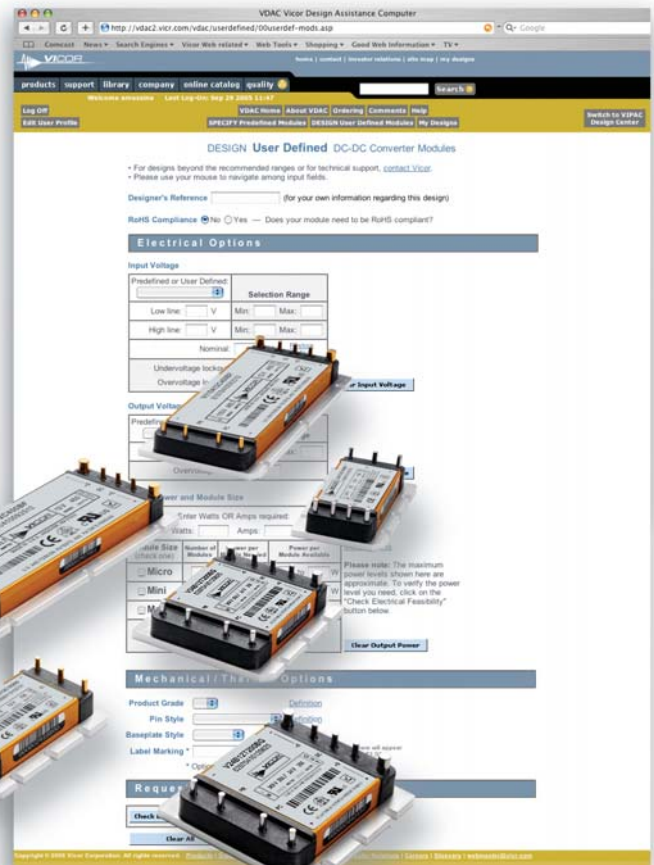

Custom Module Design System

Design your own DC-DC converters at vicorpower.com/powerbench

My Designs

An online tool for storing the designs you create

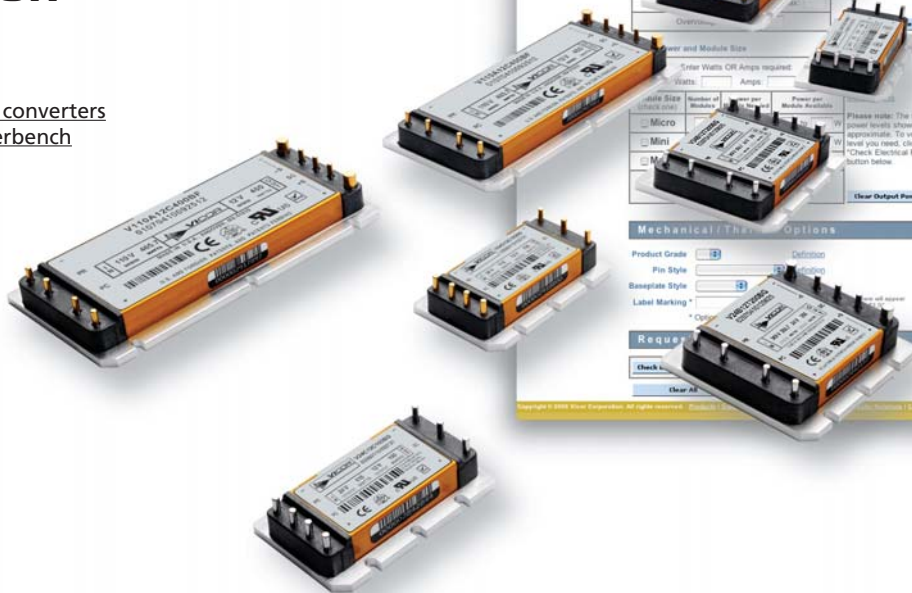

Locations Around The World

Vicor understands that technical support is critical to our customers. As a result, the Vicor Applications Engineering staff is comprised of technically competent, highly experienced field applications engineers who provide our customers with detailed technical support — within 24 hours — anywhere in the world. Our Applications Engineers, each with a thoroughly equipped lab, are established in locations across the globe ready to assist you in the pursuit of the optimum power solution.

Specifically, Vicor Field Applications Engineers offer:

- Evaluation and recommendation on specific customer design issues backed by a team of factory based Product Line Engineers.
- Answers to your technical questions by phone, fax, email, or via the Vicor website.
- Assistance with component-based power system design and power architecture assessment.
- Support for user needs through visits to your facility or at the FAE's lab.
- Technical presentations / seminars, both scheduled and on demand, at your site or elsewhere.
- A comprehensive library of up-to-date design guides, application notes, and technical articles easily accessible on the Vicor website.

This highly skilled team – assembled to include a wide range of engineering experience – has helped users develop component power solutions for thousands of applications in nearly every market segment.

Contact the Vicor Applications Group and experience Vicor's special commitment to your design. There's one goal at Vicor: to help you optimize your power design quickly and affordably. Our worldwide applications engineering staff is ready to give you technical support — NOW!

We can easily be reached by telephone or email, in North America at 800-927-9474, in Europe at 00 800 8426 7000 or in Asia at +852-2956-1782 and by email: apps@vicorpower.com.



MIL-COTS V•I Chips

DC-DC V•I Chip Modules 28 V Regulator, Voltage Transformer, & Bus Converter

Web ExpressCode: [mvichips](#)

VTMs put isolated current multiplication and voltage division directly at the point of load (POL), and an upstream PRM (Regulator) controls the factorized bus voltage supplied to the VTM to provide line and load regulation. Together, the PRM and VTM chip set provides the full functionality of a DC-DC converter, but with breakthrough performance and flexibility in a rugged, miniature package. The BCM (Bus Converter Module) functions as a fixed-ratio DC-DC transformer and provides an isolated bus voltage to power the PRM and VTM chip set or other loads.

The MIL-COTS PRM operates from a wide input range of 16 – 50 Vdc, meeting many of the ground vehicle and airborne requirements of MIL-STD-1275 and MIL-STD-704. Rated for 120 W, the 28 V PRM produces a nominal factorized bus voltage of 36 Vdc, controllable over the range of 26 – 50 Vdc. The downstream isolated VTM is available with twelve voltage division ratios from 1:1 to 1:32 and provides the user with flexibility to supply up to 100 A or 120 W at any output voltage from 1 – 50 Vdc in a surface-mount package occupying only 1 in². The MIL-COTS BCM is a high efficiency Sine Amplitude Converter (SAC) operating from a 240 to 330 Vdc primary bus to deliver an isolated 30 – 41.2 V nominal, unregulated secondary.



Features for PRM

- Input range: 16 – 50 Vdc
- 1.3 MHz switching frequency
- Efficiency: 95%
- -55°C to +125°C operation (Tj)
- ZVS buck-boost regulator

Features for VTM

- Isolated 1–50 Vdc output
- 1 μ s transient response
- 3 MHz switching frequency
- Efficiency: Up to 96.5%
- -55 to +125°C operation (Tj)

Features for BCM

- Input range: 240 – 330 Vdc
- Output range: 30.0 – 41.2 Vdc
- MIL-STD-704E/F Compliant
- Efficiency: >95%
- -55 to +125°C operation (Tj)

MIL-COTS VI BRICKs PRM / VTM Thermally Enhanced Package

Web ExpressCode: [mvib](#)

The PRM Regulator Module is a very efficient non-isolated regulator specifically designed to provide a controlled Factorized Bus distribution voltage for powering downstream VI BRICK Voltage Transformation Modules. In combination, VI BRICK PRMs and VTMs form a complete DC-DC converter subsystem offering all of the unique benefits of Vicor's Factorized Power Architecture (FPA): high density and efficiency; low noise operation; architectural flexibility; extremely fast transient response; elimination of bulk capacitance at the point of load (POL); in a thermally enhanced package.



The thermally enhanced VTM voltage transformer excels at speed, density and efficiency to meet the demands of advanced power applications. Combined with the PRM regulator they create a DC-DC converter with flexibility to provide isolation and regulation where needed. The PRM can be located with the VTM at the point of load or remotely in the back plane or on a daughtercard.



MQPI-18 Input EMI Filter

The MQPI-18 is a surface mount DC front-end filter that provides EMI filtering for Vicor's 28 V DC-DC V•I Chip or VI BRICK modules. The MQPI-18 enables designers to meet conducted emission / conducted susceptibility per MIL-STD-461E. The MQPI-18 accepts an input voltage of 10 – 80 Vdc and delivers output current up to 7 A.



MIL-COTS Product Catalog

This document provides in-depth information on Vicor's line of MIL-COTS standard products, including DC-DC converters, custom solutions, and technical support.

- Environmental stress screening and MTBF
- Environmental qualification
- Custom configured modules
- Field tested... proven reliability

Visit [vicorpower.com](#) to view the Military Catalog online.

This will give you instant access to all technical documentation for a MIL-COTS product.



USA

vicorpower.com

Vicor Corporation

(Corporate Headquarters)
25 Frontage Road
Andover, MA 01810-5413

For General Information

Tel: 978-470-2900
Fax: 978-475-6715

For Technical Support

Tel: 800-927-9474
Fax: 978-749-3341
Email: apps@vicorpower.com

For Sales Support

In U.S. & Canada: 800-735-6200
Fax: 978-475-6715
Email: vicorex@vicorpower.com

Vicor Corporation

Lombard, IL
Tel: 630-769-8780
Fax: 630-769-8782

Vicor, Westcor Division

Sunnyvale, CA
Tel: 408-522-5280
Fax: 408-774-5555
westcorpower.com

Picor Corporation

Slatersville, RI
Tel: 401-235-1100
Fax: 401-235-1117
picorpower.com

Europe

vicoreurope.com

Vicor France

Tel: +33 1 34 52 18 30
France: 0800 419 419
Benelux: 00 800 419 419 20
Fax: +33 1 34 52 28 30
Email: vicorfr@vicorpower.com

Vicor Germany

Tel: +49 89 962 439 0
Germany: 0800 018 29 18
Denmark: 00800 8426 7000
Austria: 0800 20 37 27
Fax: +49 89 962 439 39
Email: vicorde@vicorpower.com

Vicor Italy

Tel: +39 02 22 47 23 26
800 899 677
Fax: +39 02 22 47 31 66
Email: vicorit@vicorpower.com

Vicor UK

Tel: +44 1276 678222
UK: 0800 980 8427
Sweden: 020 794 143
Fax: +44 1276 681269
Email: vicoruk@vicorpower.com

Asia-Pacific

Vicor Japan Co., Ltd.

Tel: +81-3-5487-3880
Fax: +81-3-5487-3885
vicorpower.jp

Vicor Hong Kong

Tel: +852-2956-1782
Fax: +852-2956-0782
vicor-asia.com

In Latin America:

Argentina: 800-555-4288
Brazil: 0800-890-0288
Mexico: 011 52 333 647 7881

Ask the operator to connect
you to: 800-735-6200.

Vicor Custom

Vicor Custom Technical Support

Tel: 800-496-5570

Aegis Power Systems

Murphy, NC
Tel: 828-837-4029
Fax: 828-837-4106
Email: aegis@aegispower.com
aegispower.com

Convertec Corporation

Roseville, Minnesota
Tel: 651-604-0289
Fax: 651-604-0293
Email: eswanson@vicr.com

Freedom Power Systems

Cedar Park, TX
Tel: 512-259-0941
Fax: 512-259-4438
Email: sales@freedompower.com
freedompower.com

Granite Power Technologies

Manchester, NH
Tel: 603-623-3222
Fax: 603-627-3222
Email: tduff@granitepower.com
granitepower.com

Mission Power Solutions

Oceanside, CA
Tel: 760-631-6846
Fax: 760-631-6972
Email: sales@mpwrs.com
mpwrs.com

Northwest Power Integrations

Milwaukie, OR
Tel: 503-652-6161
Fax: 503-652-6868
Email: info@npi-inc.com
npi-inc.com

