

UMA Series: Small Energy Device**Contents**

1.	Principle and constituent materials of lithium ion secondary battery.....	3
1.1	Principle of lithium ion secondary battery	3
1.2	Constituent materials of lithium ion secondary battery.....	3
1.3	Criteria of selecting materials for lithium ion secondary battery	3
1.4	Constituent materials of Murata's lithium ion secondary battery	4
1.5	Structure of Murata's lithium ion secondary battery	7
2.	Lineup of Murata's lithium ion secondary battery	8
2.1	UMAC: Cylinder type.....	8
2.2	UMAL: Laminate type (Multilayer battery).....	9
3.1	Main features and your benefits	10
4.	Comparison of Murata's lithium ion secondary battery and other devices	12
4.1	Advantages compared to supercapacitors.....	12
4.1.1	High energy density	12
4.1.2	Low self-discharge : Excellent charge storage characteristic	12
4.1.3	Charge-discharge characteristic having stable voltage range: Constant output voltage	13
4.2	Advantages compared to conventional Li-ion secondary batteries	15
4.2.1	Quick Charge.....	15
4.2.2	Long cycle life	16
4.2.3	Resistant to low and high temperatures	17
4.2.4	Resistant to excessive discharge.....	19
5.	Usage and features of Murata's small energy device	20
5.1	Charge.....	20
5.2	Charge voltage and state of charge	21
5.3	Discharge	22
5.4	Temperature characteristic	25

5.4.1	Charge temperature characteristic.....	25
5.4.2	Discharge temperature characteristic.....	26
5.5	Reliability.....	27
5.5.1	Charge storage characteristic	27
5.5.2	Discharge storage characteristic.....	29
5.5.3	Load characteristic.....	30
5.5.4	Cycle characteristic	31
6.	Safety	32
6.1	High safety design of UMA series	32
6.2	Safety standard of UMA Series	32
7.	Caution for Use.....	35
7.1	Limitation of Applications.....	35
7.2	Storage Condition.....	35
7.2.1	Storage conditions before opening the packaging	35
7.2.2	Storage conditions after opening the packaging.	35
7.3.	Cautions for design.....	36
7.4.	Soldering and Assembling	36
7.5	Resin Coating.....	37
7.6	Disassembly	37
7.7	Disposal.....	37
7.8	Air transportation	37
7.9	Return of damaged or defective products	37
7.10	Recycle.....	38

1. Principle and constituent materials of lithium ion secondary battery

1.1 Principle of lithium ion secondary battery

Lithium ion secondary batteries charge/discharge electricity by lithium ion absorption and desorption between active materials of positive electrode and negative electrode.

1.2 Constituent materials of lithium ion secondary battery

Lithium ion secondary battery consists of positive electrodes, negative electrodes, electrolyte and separators. The electrolyte consists of lithium salt and organic solvent. Lithium cobalt oxides, lithium iron phosphate, lithium manganese and so on are well known as active materials for positive electrode. Popular active materials for negative electrode are graphite, amorphous carbon, lithium titanate and so on.

1.3 Criteria of selecting materials for lithium ion secondary battery

Charge-discharge voltage(V) of the battery is determined by the reaction potential difference between active materials of positive and negative electrodes at the time of Li-ion absorption/desorption(Fig.1). The higher the reaction potential at the positive electrode is and the lower the reaction potential at the negative electrode is, the higher battery voltage becomes because the reaction potential difference widens. However, when the reaction potential is high at the positive electrode, the electrolyte is easily oxidized and decomposed at the area where it contacts with active materials of the positive electrode. In the same way, when the reaction potential is low at the negative electrode, the electrolyte is easily reduced and decomposed. In other words, although a high voltage battery has large energy, it has a disadvantage that it easily deteriorates because the area where electrolyte contacts with active materials of electrodes is easily oxidized or reduced and decomposed.

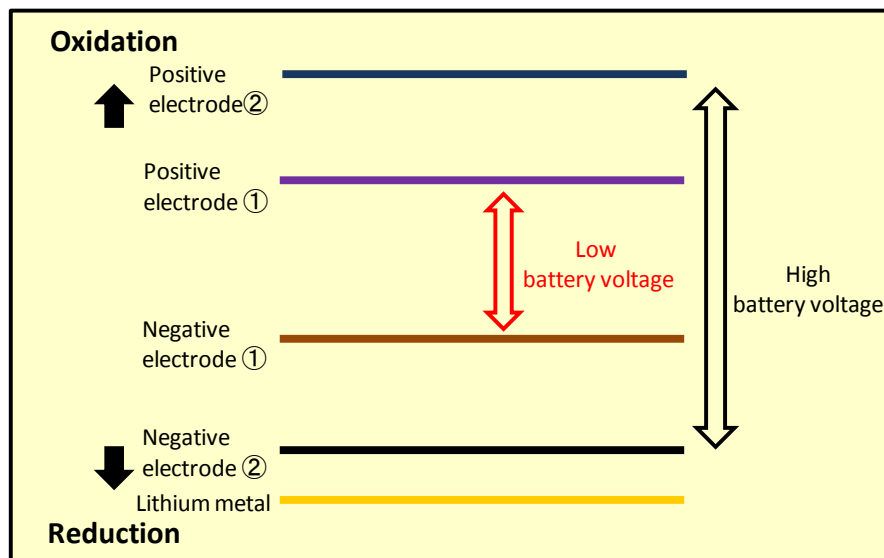

Fig.1: Relationship between the reaction potential at active materials of positive/negative electrodes and battery voltage

The battery capacity (mAh) is determined by how much Li-ions positive electrode active material can discharge and how much discharged Li-ions the negative electrode active material can receive. Therefore, the important point for a lithium ion secondary battery to have high capacity is how much active materials for positive and negative electrodes can be stuffed in unit volume.

Inside a lithium ion battery, an electrolyte in which lithium ion is dissolved is used. It works as “a carrier to transfer Li- ions” between positive and negative electrode. An electrolyte consists of lithium salt and organic solvent.

An organic solvent which is resistant to oxidative/ reductive decomposition (having a wide potential window) in which salt is easily dissociated is used for an electrolyte. A solvent having wide potential window is resistant to oxidative decomposition at positive electrode and resistant to reductive decomposition at negative electrode. By using such organic solvent, a lithium ion secondary battery gets high reliability.

A separator which has vacancies is placed between positive and negative electrodes in order to prevent a short circuit by physical contact of positive and negative electrodes without disturbing electrochemical reaction.

For effective transportation of lithium ions, separator thickness should be thin so that the distance between positive and negative electrodes becomes short, and separator porosity should be high. They lead to reduce resistance between active and positive electrode. As a result, lithium ion secondary battery can achieve high power. However, if separator thickness is too thin, or porosity is too high, short circuit may occur by the physical contact of positive and negative electrode. Therefore, it is important to select a separator having appropriate thickness and porosity.

1.4 Constituent materials of Murata’s lithium ion secondary battery

Murata’s small energy device (UMA series) is a kind of lithium ion secondary battery. Therefore we call our small energy device as lithium ion secondary battery in this technical note.

For getting distinctive features explained in “3.1 Main features and your benefits”, we choose optimum materials for active materials of electrodes, electrolyte, separator, and so on. Lithium cobalt oxide is used as positive electrode active material and lithium titanate is used as negative electrode active material in Murata’s lithium ion secondary battery.

Fig.2 shows the chemical reaction formula at the time of charge-discharge of Murata’s lithium ion secondary battery.

Positive electrode

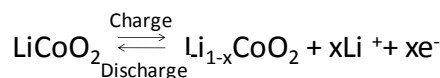

Negative electrode

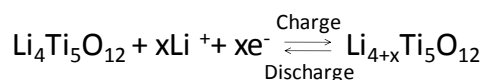

All reaction

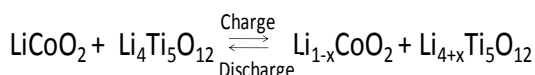

Fig.2: Chemical reaction formula of Murata’s Li-ion secondary battery

Unlike a supercapacitor, the Li-ion secondary battery has low self-discharge characteristic because Li-ion absorption/desorption occurs by the electrochemical reaction shown in Fig.2.

In the electrolyte, lithium ions are solvated. In the solvent state, negative electrode active material cannot absorb lithium ions. On the surface of negative electrode active material, there is a solid electrolyte interface (SEI) layer formed by decomposition of the organic solvent after reacting with Li-ion. When crossing this layer, solvated ions are dissolved and absorbed in negative electrode active materials (Fig.3).

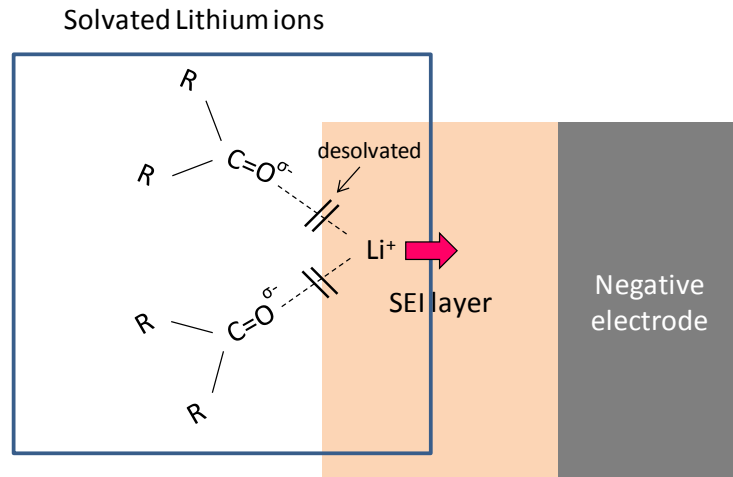

Fig.3: State of Li-ions in the electrolyte

However, high resistance is generated when Li-ions pass through the SEI layer. The thicker the SEI layer is, the higher resistance becomes. In addition, some Li-ions are trapped when SEI layer is formed.

SEI layer is formed on the surface of negative electrode active material where it contacts with electrolyte. When negative electrode active material has high reaction potential, electrolyte is resistant to reductive decomposition. Therefore, negative electrode active material having high reaction potential should be used in order to reduce thickness of SEI layer.

In general Li-ion secondary batteries, carbon material called graphite is used as negative electrode active material. The reaction potential of graphite for Li-ion absorption/desorption is very low: 0.1V vs. Li/Li+. On the other hand, lithium titanate is used for Murata's Li-ion secondary battery. Its potential is 1.55V vs. Li/Li+. Therefore it can absorb/desorb Li-ion at higher potential than graphite (Fig.4).

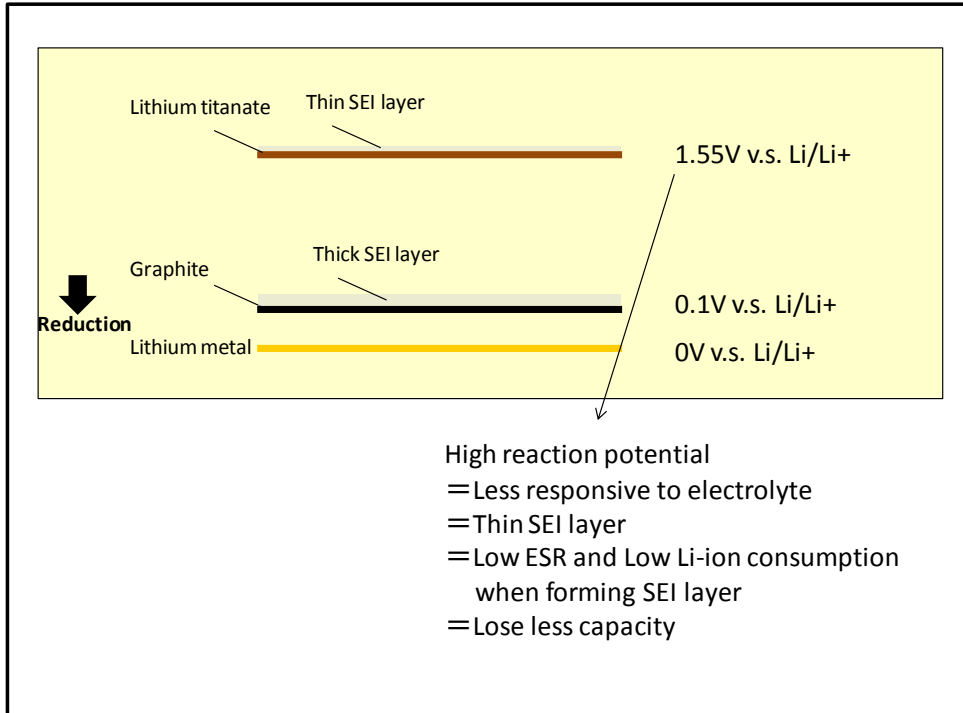

Fig.4: Relationship between reaction potential of negative-electrode active material and forming SEI layer

As shown in Fig.4, when using lithium titanate which has relatively high reaction potential for Li-ion absorption/desorption, formed SEI layer is thinner than when using graphite. It contributes to lower the resistance and reduce the amount of Li-ions trapped when SEI layer is formed. As a result, a battery can get high temperature endurance and good cycle characteristic. In addition, these features are improved by optimizing constituent materials for electrode, separator and electrolyte.

1.5 Structure of Murata's lithium ion secondary battery

The electrode group of Murata's lithium ion secondary battery consists of sheeted aluminum foils, active materials, and sheeted separators. Each active material is coated on aluminum foils. Separators are placed between positive and negative electrodes in order to prevent short circuit caused by physical contact of electrodes. After making electrode group by rolling up or layering positive/negative electrodes and separators, aluminum tabs are conductively connected to it as external terminals (Fig.5).

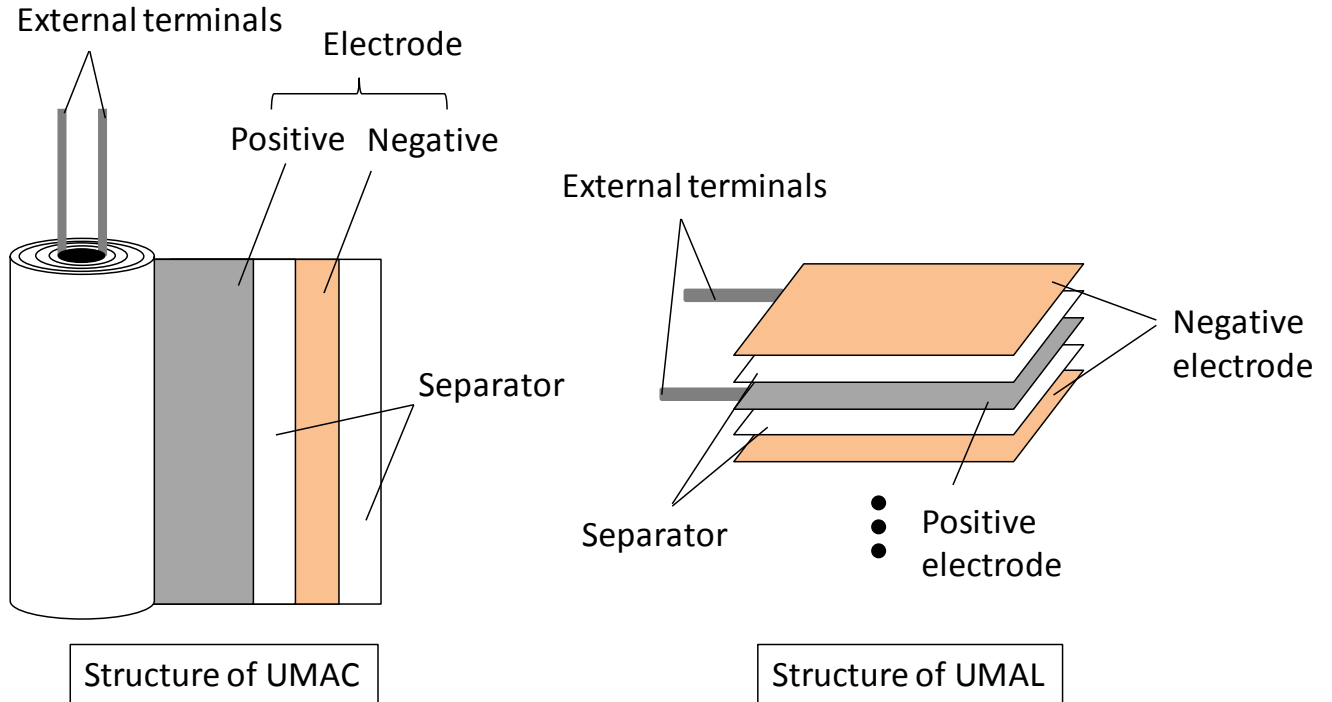

Fig.5: Structure of UMA series

After putting the electrode group in an aluminum case or laminate package and injecting electrolyte, the case is sealed.

2. Lineup of Murata's lithium ion secondary battery

2.1 UMAC: Cylinder type

UMAC is cylinder shaped battery. Because of its long cylindrical package, it is suitable for cylindrical devices which have limitation in length or width. This device can be charged by constant voltage of 2.7V in spite of the presence or absence of current limitation. The following table shows the specification of UMAC.

Table 1: Specifications (Part number: UMAC040130A003TA01)

Item		Specification
Capacity		3mAh [±20%]
ESR @1kHz ^{*1}		800 mΩ [max 960mΩ]
Voltage	Nominal voltage ^{*1}	2.3V
	Cut-off voltage ^{*1}	1.8V
	Charge voltage ^{*1}	2.7V
Current	Max.continuous discharge current	30mA
	Max. charge current	150mA
Temperature	Operation temperature range	-20°C~+70°C
	Storage temperature range	-20°C~+70°C

^{*1} Capacity measurement: [Pretreatment] <Discharge>Discharge down to 1.8V at 1CA/ Temp.:25°C
 ⇒<Rest>30sec./Temp.:25°C ⇒ <Charge> CC Charge to 2.7V at 1CA. Then CV charge at 2.7V. CV charge end: until charge current becomes 0.05CA or after 30 minutes/Temp:25°C
 ⇒<Rest>30sec/Temp.:25°C
 ⇒[Measurement] <Discharge>Discharge down to 1.8V at 1CA/ Temp.:25°C
 ESR measurement: [Pretreatment] <Charge> CC Charge to 2.7V at 1CA. Then CV charge at 2.7V. CV charge end: until charge current becomes 0.05CA or after 30 minutes/Temp:25°C
 ⇒<Rest>30sec/Temp.:25°C
 ⇒[Measurement] <AC method>Measured at AC1kHz/Temp.:25°C
 Nominal voltage : Voltage between the terminals when using battery under the normal condition
 Charge voltage : Upper limit of voltage for battery charge
 Cut-off voltage : Lower limit of voltage for battery discharge

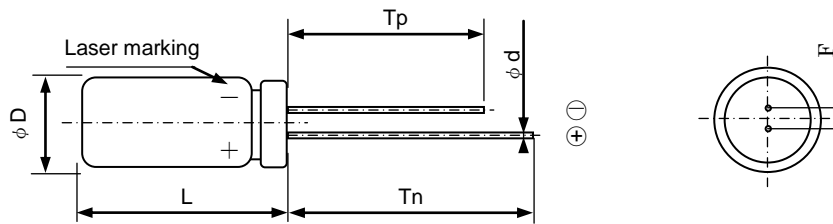

Dimension	[mm]
φD	4.0 ^{0.0} / _{-0.2}
L	12.0 ^{+0.5} / _{-0.4}
φd	0.45 ±0.05
Tp	17.0±1.0
Tn	21.0±1.0
F	1.5 (length between terminal roots) ±0.5

Fig.6: Shape and dimension (UMAC040130A003TA01)

2.2 UMAL: Laminate type (Multilayer battery)

UMAL is multilayer battery. Because of its flat package, it is suitable for devices which have limitation in thickness. This device can be charged by constant voltage of 2.7V in spite of the presence or absence of current limitation.

As explained in “1.5 Structure of Murata’s lithium ion secondary battery”, UMAC and UMAL have different electrode structures. Because the stress on electrode in layered structure is smaller than that of cylinder type and because external terminals contacting each electrode of stacked layers can collect more electricity, UMAL has superior characteristics such as cycle life. The following table shows the specification of UMAL.

Table 2: Specifications (Part number: UMAL361421B024TA01)

Item		Specification
Capacity		24mAh [+/-20%]
ESR @ 1kHz ^{*1}		100 mΩ [max 125mΩ]
Voltage	Nominal voltage ^{*1}	2.3V
	Cut-off voltage ^{*1}	1.8V
	Charge voltage ^{*1}	2.7V
Current	Max.continuous discharge current	240mA
	Max. charge current	960mA
Temperature	Operation temperature range	-20°C~+70°C
	Storage temperature range	-20°C~+70°C

^{*1} Capacity measurement: [Pretreatment] <Discharge>Discharge down to 1.8V at 1CA/ Temp.:25°C
 =><Rest>30sec./Temp.:25°C => <Charge> CC Charge to 2.7V at 1CA. Then CV charge at 2.7V. CV charge end: until charge current becomes 0.05CA or after 30 minutes/Temp.:25°C
 =><Rest>30sec/Temp.:25°C
 =>[Measurement] <Discharge>Discharge down to 1.8V at 1CA/ Temp.:25°C
 ESR measurement: [Pretreatment] <Charge> CC Charge to 2.7V at 1CA. Then CV charge at 2.7V. CV charge end: until charge current becomes 0.05CA or after 30 minutes/Temp.:25°C
 =><Rest>30sec/Temp.:25°C
 =>[Measurement] <AC method>Measured at AC1kHz/Temp.:25°C
 Nominal voltage : Voltage between the terminals when using battery under the normal condition
 Charge voltage : Upper limit of voltage for battery charge
 Cut-off voltage : Lower limit of voltage for battery discharge

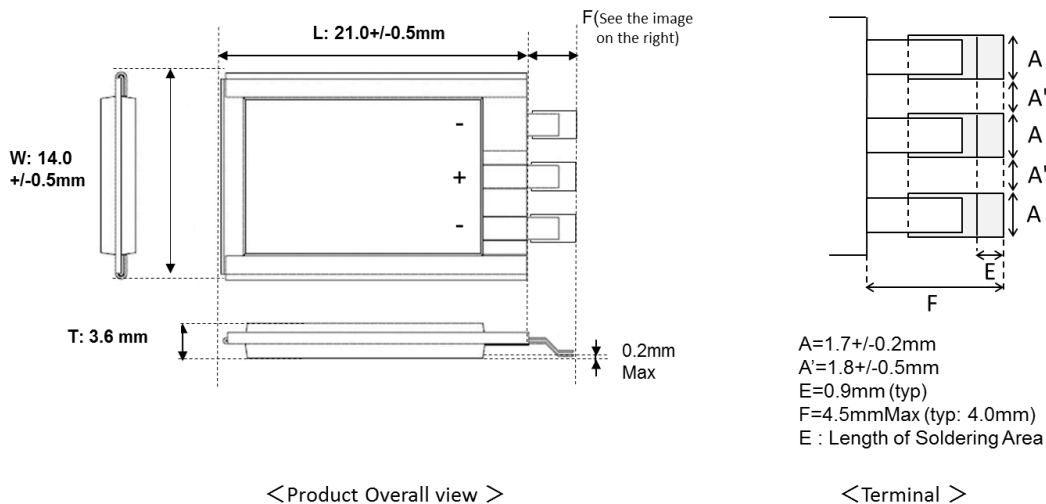

Fig. 7: Shape and dimension (UMAL361421B024TA01)

3. Features of Murata’s lithium ion secondary battery and your benefits

3.1 Main features and your benefits

Murata’s lithium ion secondary battery (UMA series) has higher capacity and lower leakage current than conventional supercapacitors. Compared to conventional lithium ion secondary batteries, UMA series has more rapid charge-discharge characteristic and longer cycle life.

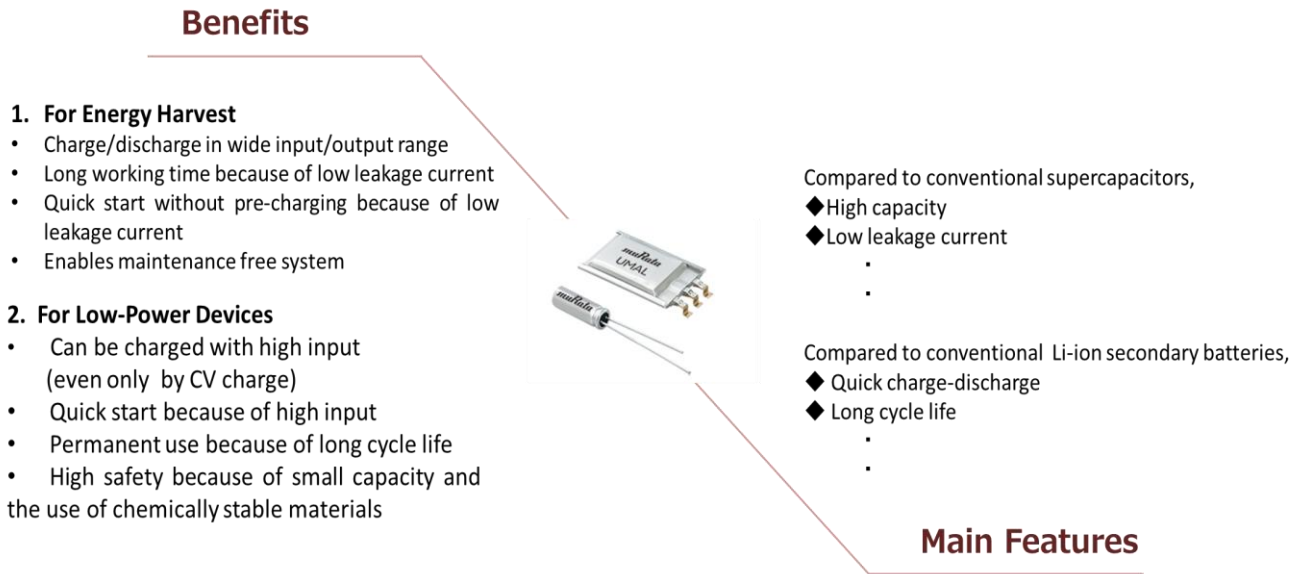

Fig. 8: Main features and your benefits

UMA series can provide higher output power compared to conventional Li-ion secondary batteries per unit volume. In addition, UMA series have much higher capacity than conventional supercapacitors per unit volume. Therefore, UMA series can provide higher power for a longer time than conventional Li-ion secondary batteries or supercapacitors.

For example, driving a small motor needs tens of milliamps(**mA) of current. A general small lithium ion battery of the similar size of UMA series cannot provide such high current and cannot drive the motor. On the other hand, supercapacitor of the similar size of UMA series can drive it for short time. However it cannot drive it for a long time because of its low capacitance.

To be specific, the working ranges of UMA series are as follows (Fig. 9);

UMAC040130A003TA01: 0.75W × 0.04sec ~ 6mW × 1.2h ~ 0.06mW × 138h

UMAL 361421B024TA01: 3.0W × 0.28sec ~ 100mW × 1.0h ~ 6mW × 5.3h

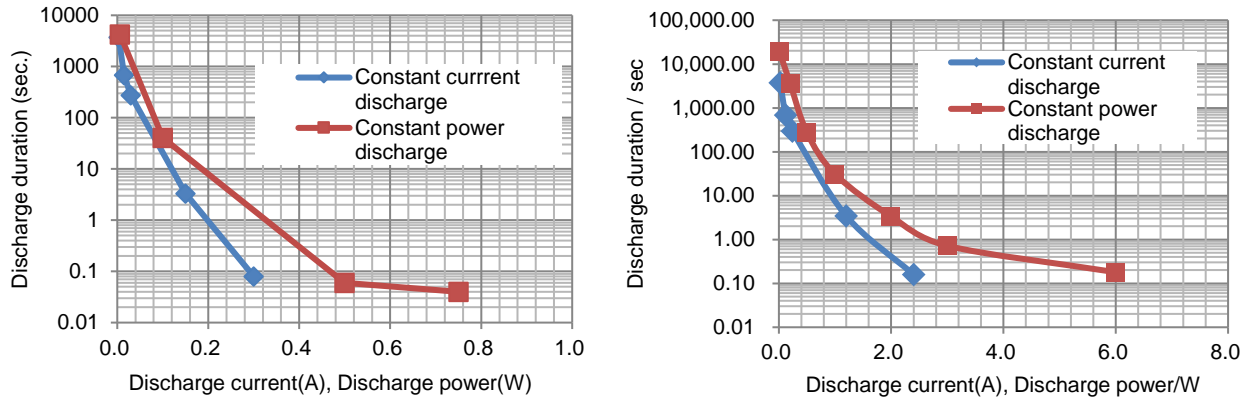

**Fig. 9: Discharge current(A), discharge power(W), and discharge time(sec.)
 (Left: UMAC040130A003TA01, Right: UMAL361421B024TA01)**

In sum, UMA series is a new energy device combining the beneficial features of Li-ion secondary battery and supercapacitor.

Therefore UMA series is suitable for the following applications.

- (1) Charge rapidly at high current and discharge at low current for long time operation
- (2) Charge at low current for a long time and discharge rapidly at high current
- (3) Charge rapidly at high current and discharge rapidly at high current

4. Comparison of Murata’s lithium ion secondary battery and other devices

4.1 Advantages compared to supercapacitors

4.1.1 High energy density

UMA series has 40 times higher energy density than same size supercapacitor (Murata’s product). Because of this ultra-high energy density, UMA series can run devices for a longer time than a supercapacitor.

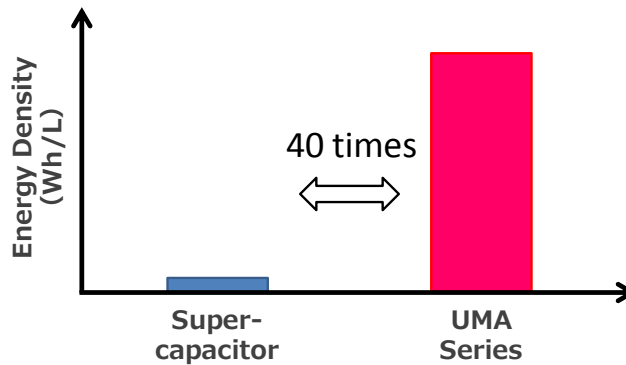

Fig.10: Energy density comparison of supercapacitor and UMA series

4.1.2 Low self-discharge : Excellent charge storage characteristic

UMA series has lower self-discharge characteristic than supercapacitors because Li-ion absorption/desorption occurs by the electrochemical reaction as explained in “1.4 Constituent materials of Murata’s lithium ion secondary battery”. Because lithium titanate is used for negative electrode, charge (capacity) retention rate is high even at high temperature.

“Charge (capacity) retention rate = discharge capacity after exposed under each condition / Charge capacity before exposure ×100”

Fig.11 and **Fig.12** show examples of charge (capacity) retention rate of UMAC040130A003TA01 and UMAL361421B024TA01 exposed at each temperature after full charge.

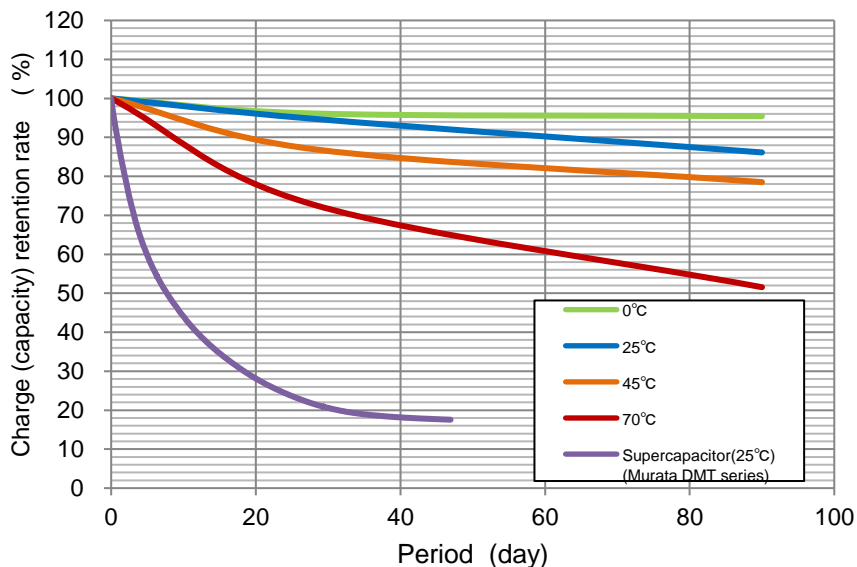

Fig.11 : Charge (capacity) retention rate of UMAC040130A003TA01 exposed at each temperature after full charge

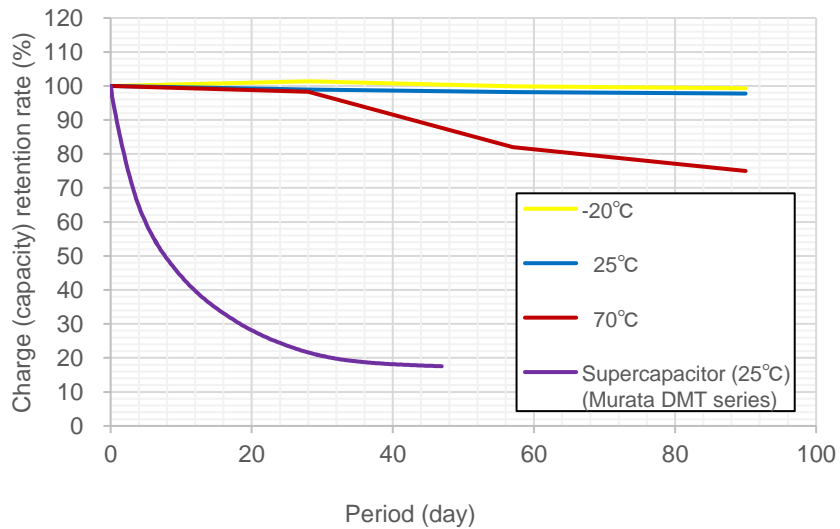

Fig.12 : Charge (capacity) retention rate of UMAC040130A003TA01 exposed at each temperature after full charge

The result shows both UMAC040130A003TA01 and UMAC040130A003TA01 have very high charge (capacity) retention rate;

UMAC040130A003TA01: over 80% after 90 days at 25°C, 50% after 90 days at 70°C.
 UMAC040130A003TA01: over 90% after 90 days at 25°C, 75% after 90 days at 70°C. Calculated from the charge (capacity) retention rate after full charge at 25°C, the leakage current of UMAC040130A003TA01 is about 200nA and that of UMAC040130A003TA01 is about 500nA.

Thus, because of low self- discharge characteristic, charged energy can be kept for a long time and used effectively even under the situation such as energy harvesting system where UMA series may be exposed for a long time without charging.

4.1.3 Charge-discharge characteristic having stable voltage range: Constant output voltage

UMA series has the discharge curve having flat voltage potential curve around 2.3V. Unlike supercapacitor which has a linear discharge curve, UMA series can drive device whose working voltage is around 2.0V without boosting voltage by DC/DC converter (black dot line in Fig.13).

Fig.13 shows the discharge curve of UMAC040130A003TA01 and 3F supercapacitor.

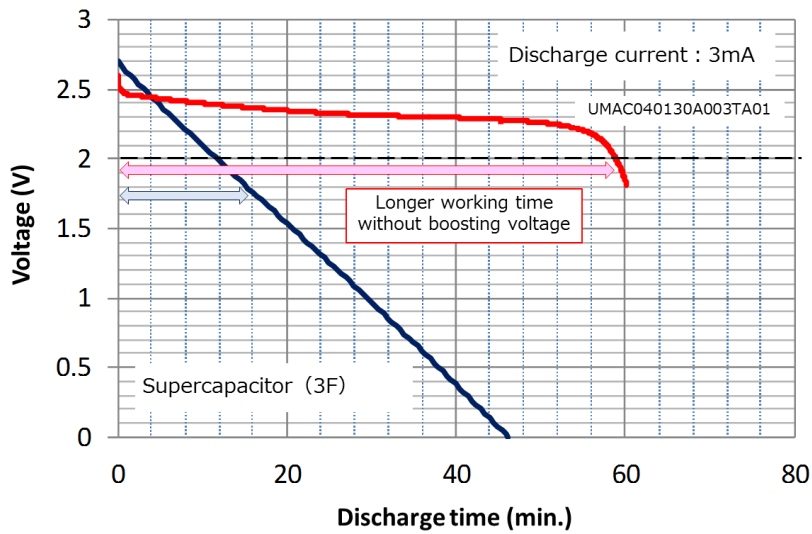

Fig.13: Discharge curves of UMAC and supercapacitor(capacitance:3F)

Compared to general supercapacitors, UMA series has much higher capacity which can be used without voltage boost.

It takes time and energy to charge a supercapacitor which has a linear charge-discharge curve to 2.0V. On the other hand, because UMAC040130A003TA01 has flat voltage potential curve around 2.3V, its voltage becomes 2.3V soon after charge for a short time. Therefore UMAC040130A003TA01 can drive the device whose working voltage is around 2.0V soon after short-time charge. **Fig.14** shows the 3mA charge curve of UMAC040130A003TA01 and 3F supercapacitor.

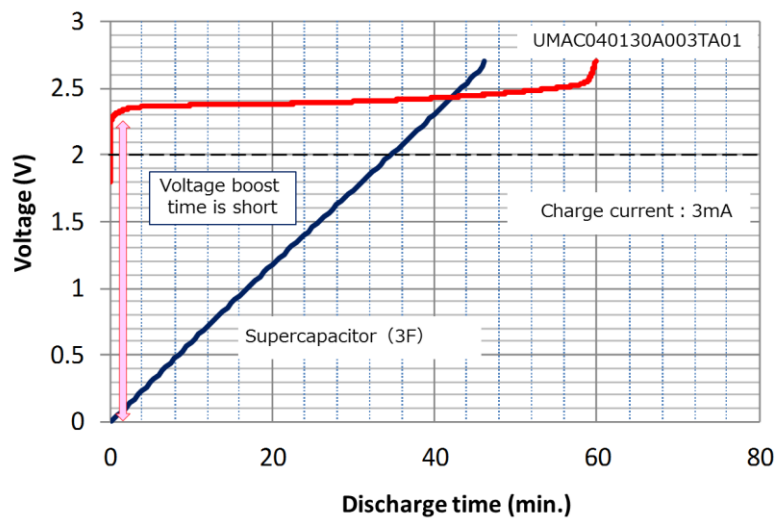

Fig.14: Charge curves of UMAC040130A003TA01 and supercapacitor (capacitance: 3F)

4.2 Advantages compared to conventional Li-ion secondary batteries

4.2.1 Quick Charge

While it takes about one hour to charge conventional Li-ion secondary battery, UMA series can be charged very quickly.

Charge characteristic of UMAC040130A003TA01 is shown in Fig.15. When charging UMAC040130A003TA01 by CV charge (constant voltage charge), over 90% of total capacity is charged in five minutes.

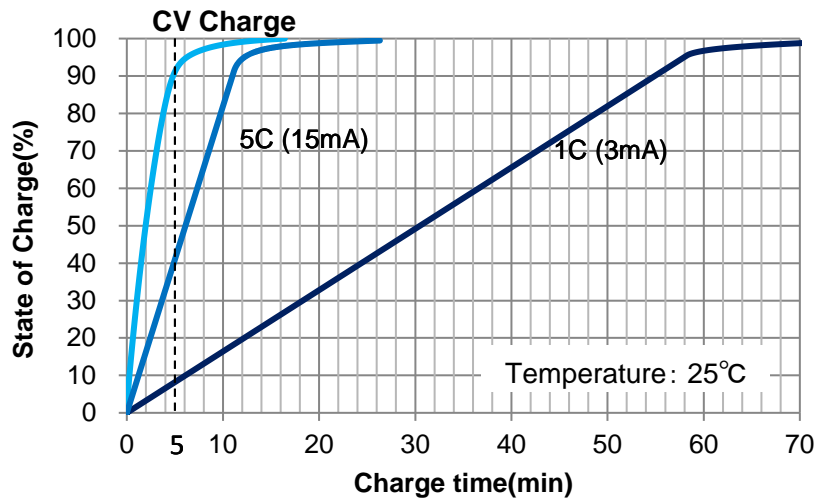

Fig.15: Quick charge at 25°C(UMAC040130A003TA01)

Charge characteristic of UMAL361421B024TA01 is shown in Fig.16. When charging UMAL361421B024TA01 by CV charge, over 95% of total capacity is charged in five minutes.

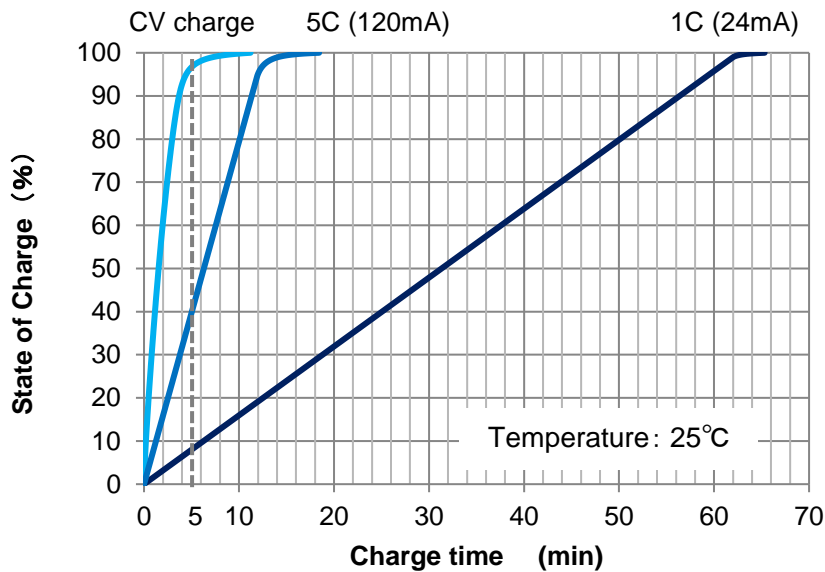

Fig.16: Quick charge at 25°C(UMAL361421B024TA01)

Therefore, UMA series can drive device soon by quick charge in case of run out.

4.2.2 Long cycle life

UMA series has very superior cycle characteristic compared to conventional Li-ion secondary batteries. It keeps good cycle characteristic even after repeated quick charge-discharge cycles.

Cycle characteristic of UMAC040130A003TA01 after repeated quick charge-discharge cycle is shown in Fig. 17. For comparison, 0.5C charge-discharge cycle characteristic of conventional Li-ion secondary battery(LIB) is also shown in Fig. 17.

“0.5C charge-discharge” means repeating charge-discharge at low current that takes two hours for charge and two hours for discharge. Generally speaking, high current charge-discharge is not applied to LIB because it deteriorates battery performance quickly. As explained in “1.4 Constituent materials of Murata’s lithium ion secondary battery”, UMA series has low reaction resistance because of its thin SEI layer. Therefore it can be charged by quick charge at high current.

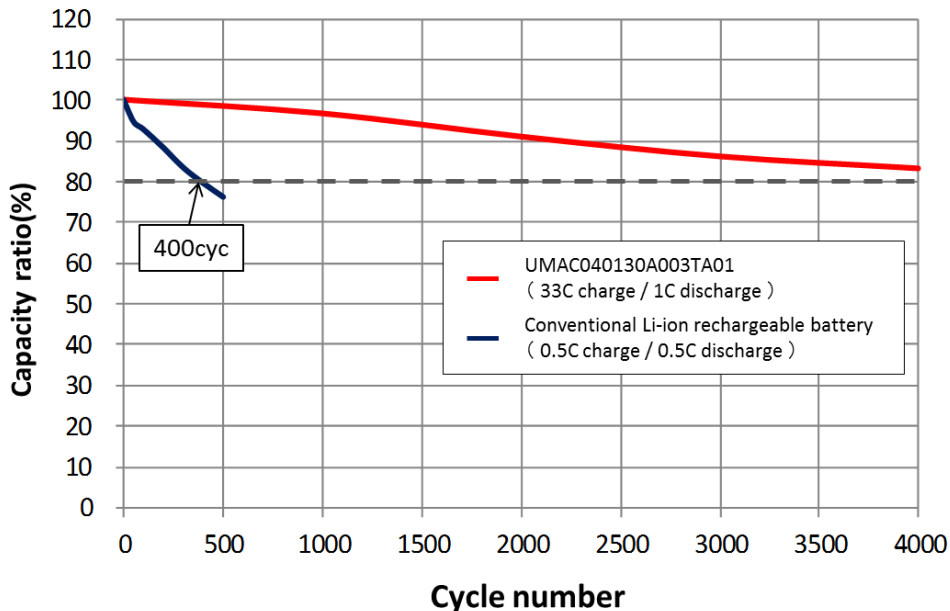

Fig. 17: Charge-discharge cycle characteristic of UMAC040130A003TA01 after repeated quick charge-discharge cycle (Capacity ratio vs. initial value)

Capacity of conventional Li-ion secondary battery is deteriorated by repeated charge-discharge even at slow charge condition. On the other hand, UMA series can keep high capacity(charge) ratio even after repeated quick charge-discharge. It means UMA series can be used for long time even when quick charge-discharge cycle is repeated.

4.2.3 Resistant to low and high temperatures

Fig. 18 and Fig.19 show the charge-discharge curves of UMAC040130A003TA01 at 0°C~70°C.

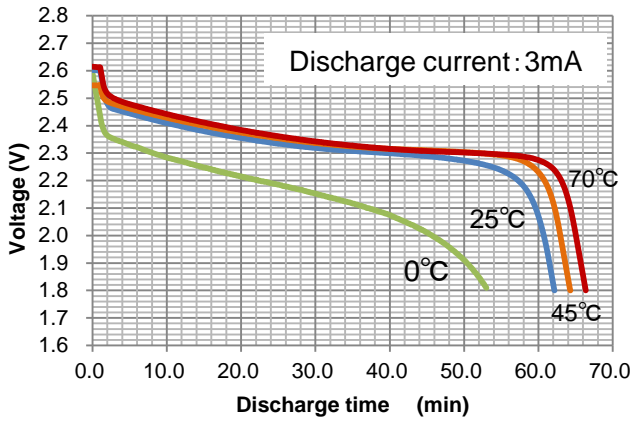

Fig. 18: Discharge curve at 0°C~70°C (UMAC040130A003TA01)

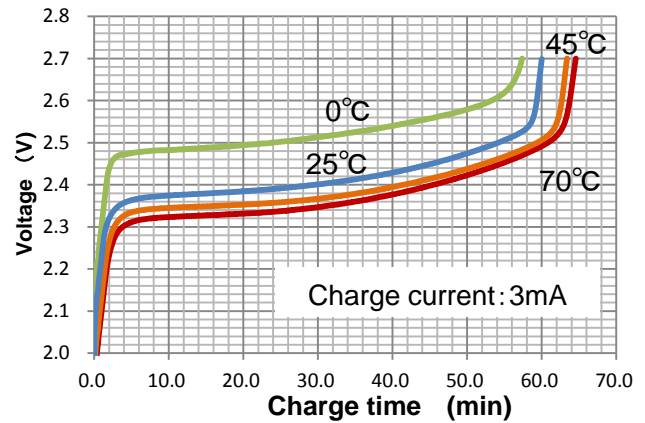

Fig. 19: Charge curve at 0°C~70°C (UMAC040130A003TA01)

Fig. 20 and Fig. 21 show the charge-discharge curves of UMAL at 0°C~70°C.

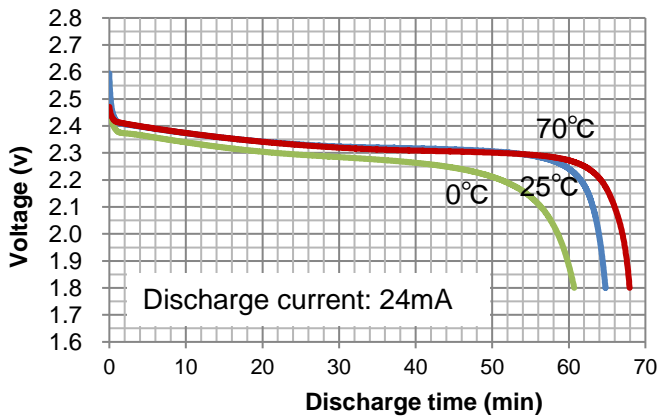

Fig. 20: Discharge curve at 0°C~70°C (UMAL361421B024TA01)

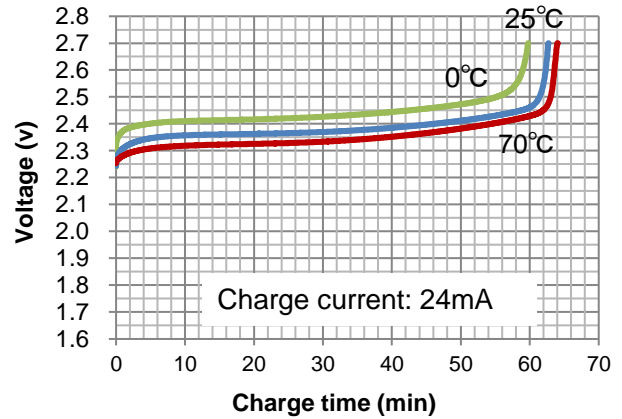

Fig. 21 : Charge curve at 0°C~70°C (UMAL361421B024TA01)

Fig. 22 shows the discharge curves of UMAC040130A003TA01 when it is discharged by 0.6mA continuously at -20°C. In addition, Fig. 23 shows the discharge curves of UMAC040130A003TA01 when it is pulse discharged pulse discharged by the cycle of (1)30mA, 10msec discharge (2) Rest 15sec. at -20°C. Compared to conventional lithium ion batteries, UMA series can charge-discharge higher power even at low temperatures.

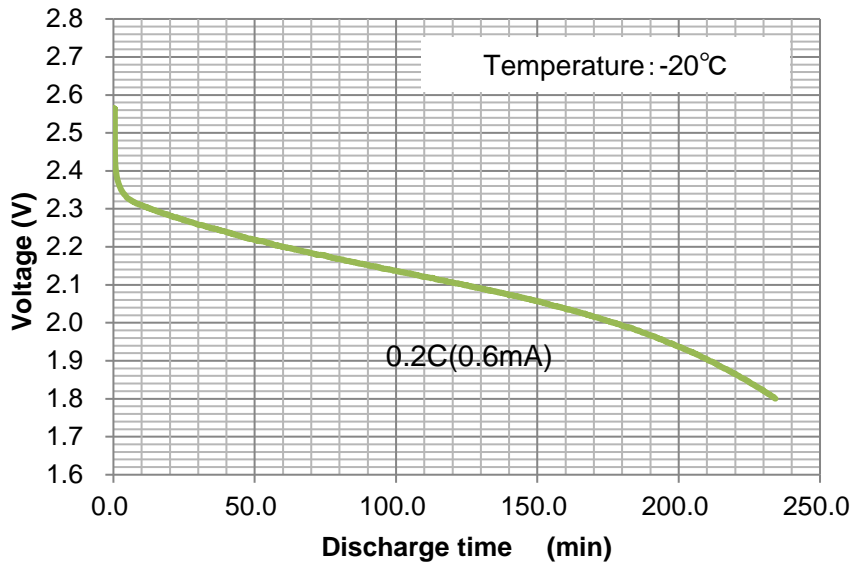

Fig. 22 Discharge curve at -20°C (UMAC040130A003TA01)

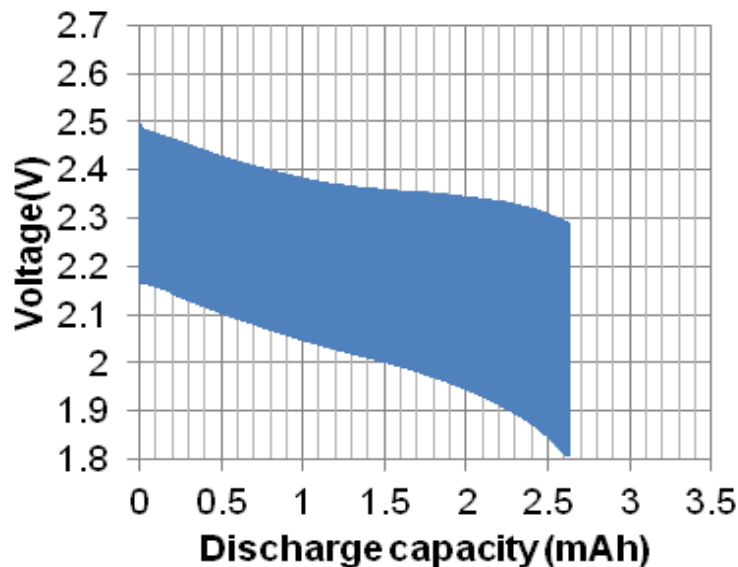

Fig. 23 Pulse discharge by the cycle of (1)30mA, 10msec discharge (2) Rest 15sec. at -20°C (UMAC040130A003TA01)

As shown in these graphs, UMA series can keep its performance at wide temperature range between -20°C to 70°C. Therefore UMA series can be used under various conditions or in various areas.

4.2.4 Resistant to excessive discharge

UMA series has higher resistant to excessive discharge compared to conventional Li-ion secondary batteries.

Recommended cut-off voltage of UMA series is 1.8V at which UMA series can provide its performance fully. However, even if UMA series is stored at 0V (short circuited) for a long time or discharged excessively to 0V, it can be charged again dozens of times.

For example, voltage of UMA series may be fully discharged to 0V if it is stored without charge for a long time and IC or other part consumes charge in UMA series. Even if this case occurs several times in one year, UMA series can be charged again up to dozens of times.

Fig. 24 shows the test result of charge-discharge cycle test where UMAC040130A003TA01 was excessively discharged to 0V. Even after 10 cycles of excessive discharge to 0V, capacity is about 99% of the initial value.

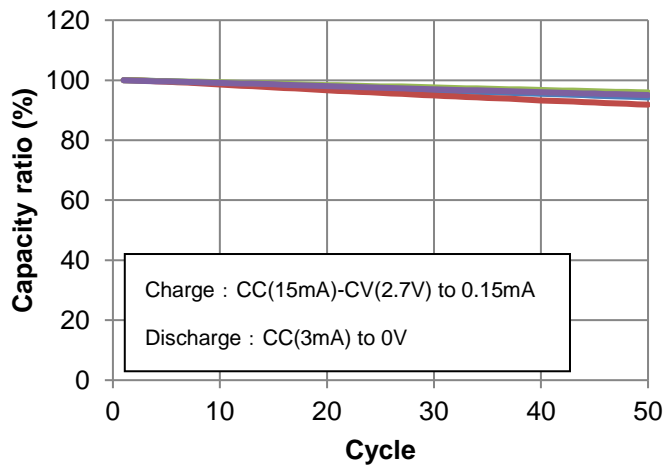

Fig. 24 Capacity ratio (vs. initial value) in the excessive discharge cycle test

In conventional Li-ion secondary batteries, copper foils are used as collectors because graphite is used as negative electrode active material. Aluminum foils cannot be used (Fig. 25). This is because the electric potential at which graphite reacts with Li-ion is same as the potential at which aluminum foil alloys react with lithium. Conventional Li-ion secondary batteries cannot be discharged excessively because the copper foils are dissolved and the copper precipitate may cause short circuit when battery voltage becomes 0V.

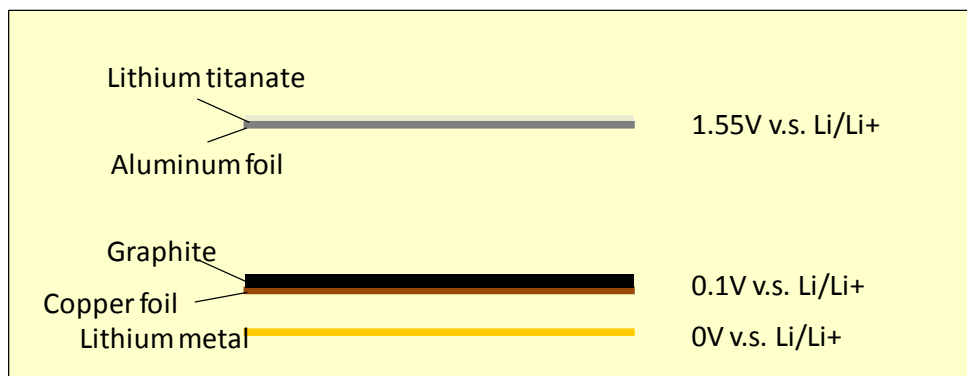

Fig. 25: Negative electrode active material and electrode foil

On the other hand, in UMA series, aluminum foils can be used because lithium titanate, whose electric potential at which it reacts with Li-ion is high, is used as negative electrode active material. UMA series does not short circuit even if its voltage becomes 0V because aluminum foils are not dissolved.

5. Usage and features of Murata’s small energy device

5.1 Charge

UMA series should be charged by CC-CV charge or CV charge. In CC-CV charge method, a device is charged at constant current until its voltage reaches upper voltage of 2.7V (Constant current (CC) charge). Then it is kept charged without further increase in voltage (Constant voltage (CV Charge)). In CV charge method, a device is charged at constant voltage of 2.7V (Constant voltage (CV Charge)).

For setting upper current and voltage, please refer to the maximum charge current and maximum charge voltage of UMA series shown in Table 1 and Table 2. **Fig. 26** shows an example of transition of battery voltage and charge current. UMAL361421B024TA01 is charged at 2.7V by CC-CV charge.

【Charge condition(CC-CV charge) of UMAL361421B024TA01】

Mode	Current	Charge voltage	Cut-off current	Temperature
Charge	24.0mA	2.7V	0.60mA	25°C

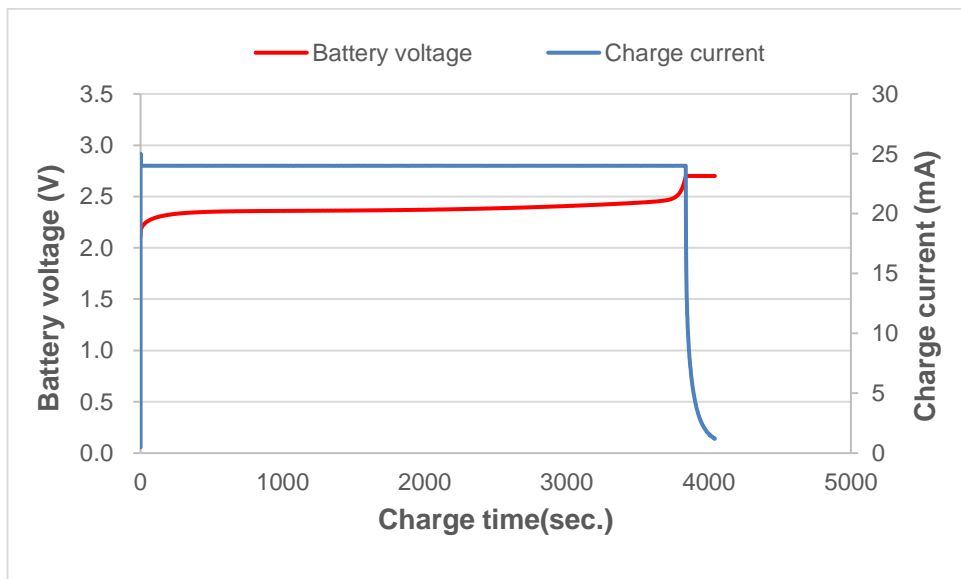

Fig. 26: Charge time, charge voltage and charge current (CC-CV charge of UMAL361421B024TA01)

As shown in Fig. 26, in CC- CV charge method, constant current of 24.0mA is applied up to 2.7V at 25°C (CC charge). Then keep the constant voltage of 2.7V after the voltage reaches 2.7V. Stop charge when charge current gradually drop to 0.60mA.

Fig. 27 shows an example of transition of battery voltage and charge current when charging UMAL361421B024TA01 at 2.7V by CV charge.

【Charge condition(CV charge) of UMAL361421B024TA01】

Mode	Current	Charge voltage	Cut-off current	Temperature
Charge	-	2.7V	1.2mA	25°C

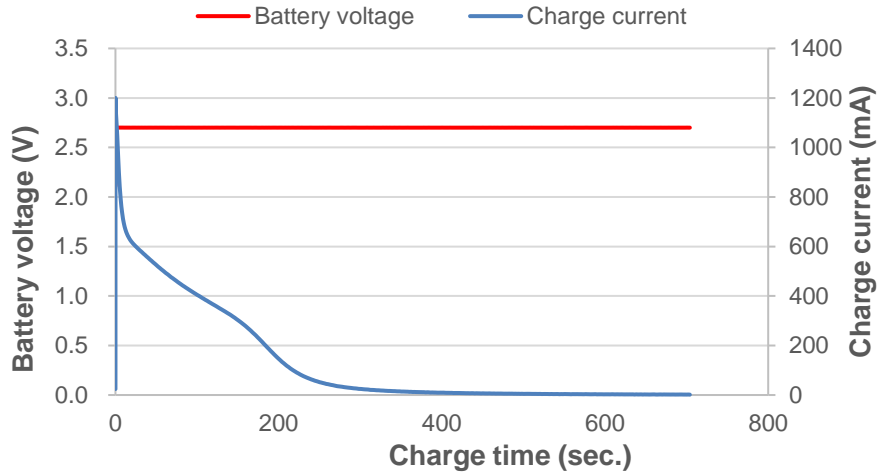

Fig. 27 Charge time, charge voltage and charge current (CV charge of UMAL361421B024TA01)

As shown in Fig. 27, in CV charge method at 2.7V, Charge UMAL with keeping the constant voltage of 2.7V and stop charging when charge current gradually drop to 0.60mA.

5.2 Charge voltage and state of charge

Charge capacity varies depending on charge voltage. Fig. 28 shows the relationship between charge voltage and state of charge (UMAC040130A003TA01).

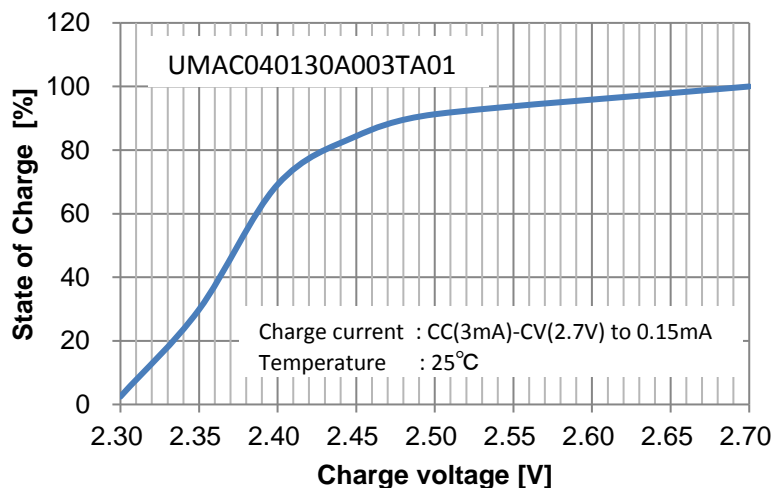

Fig. 28 Charge voltage and state of charge (UMAC040130A003TA01)

UMA series cannot be necessarily charged at charge voltage(2.7V). However, please be aware when charge capacity is small, available discharge capacity is also small.

5.3 Discharge

When the voltage of UMA series lowers than 1.8V, cycle characteristic is deteriorated. Therefore please be sure to set cut-off voltage to 1.8V or more. Discharge time depends on discharge current.

Fig. 29 and Fig. 30 show an example of discharge condition, transition of battery voltage and discharge capacity.

【Discharge characteristic (Depending on current)】

Mode	Current	Cut-off voltage	Cut-off current	Temperature
Discharge	each current	1.8V	-	25°C

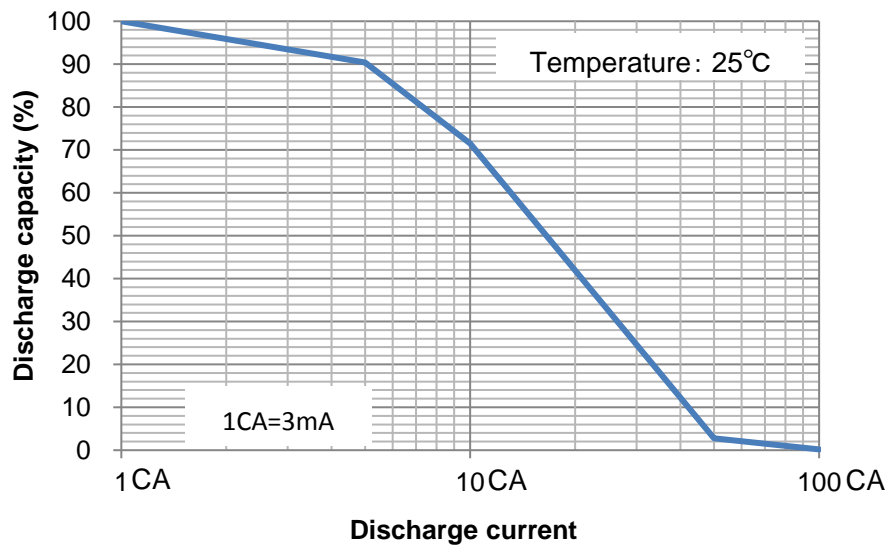
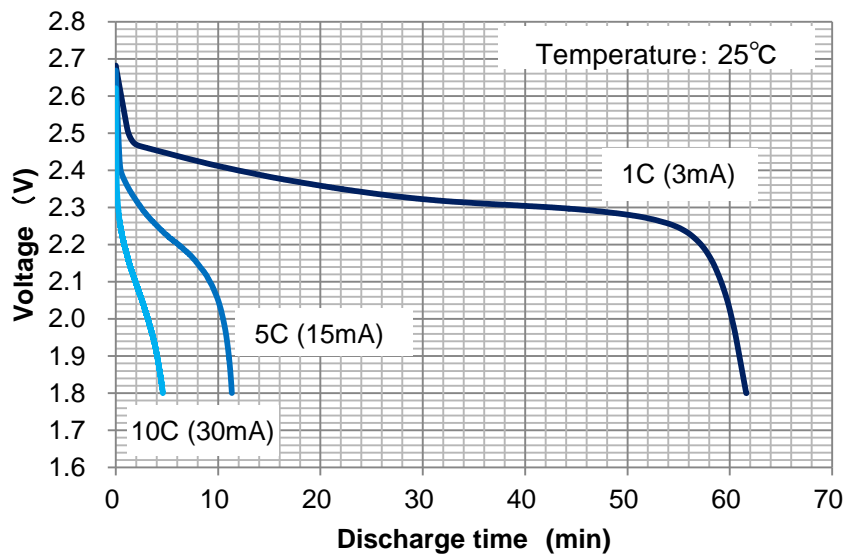

Fig. 29: Relationship between discharge current and discharge capacity (UMAC040130A003TA01)

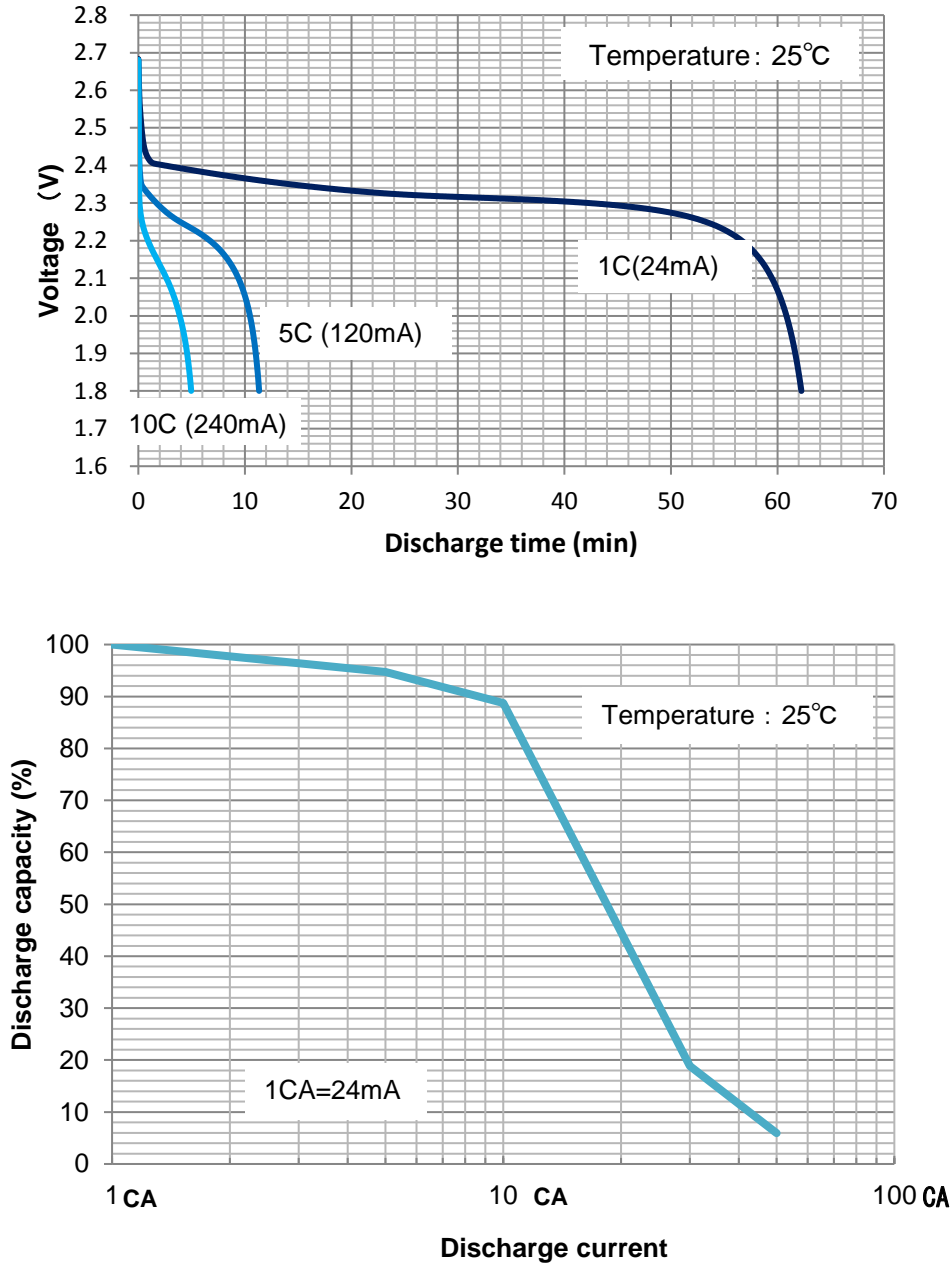

Fig. 30: Relationship between discharge current and discharge capacity (UMAL361421B024TA01)

As shown in Fig. 29 and Fig. 30, UMAC040130A003TA01 can discharge for about one hour at 3mA, for about 250 seconds (about four minutes) at 30mA. UMAL361421B024TA01 can discharge for about one hour at 24mA, for about 300 seconds (about five minutes) at 240mA. Because of internal resistance of battery, battery voltage drops to 1.8V quickly when discharge current is high. Therefore discharge capacity becomes low when discharge current is high.

Table 3 shows some examples of ICs which can control charge-discharge of UMA series. Murata has already performed an operation check of the described ICs below; however, we do not guarantee on the IC operation. Please confirm the operation by yourself when you consider these ICs.

Table 3: Recommended IC and changes of peripheral circuits

Supplier	Part #	Adjustment	OVP	UVP
Analog Devices	ADP5090	RTerm1=2.2MΩ RTerm2=4.7MΩ RSD1=3.3MΩ RSD2=4.7MΩ	2.66V	2.06V
Analog Devices	ADP5091 ADP5092	RTerm1=3.9MΩ RTerm2=5.1MΩ RSD1=3.3MΩ RSD2=4.7MΩ	2.68V	2.02V
LinearTechnology	LTC3105	R1=560kΩ R2=330kΩ	2.7V	- (No UVP control)
STMicro Electronics	SPV1050	R4=6.2MΩ R5=1.4MΩ R6=6.4MΩ	2.69V	2.2V
TI	BQ25504	ROV1=4.7MΩ ROV2=2MΩ	2.66V	2.2V
TI	BQ25505	ROV1=4.7MΩ ROV2=2.2MΩ	2.66V	1.95V
TI	BQ25570	ROV1=4.7MΩ ROV2=2.2MΩ	2.66V	1.95V

5.4 Temperature characteristic

5.4.1 Charge temperature characteristic

Moving speed of Li-ion in electrolyte is dependent on temperature. Thus, battery internal resistance is also dependent on temperature. Therefore charge capacity or discharge capacity may vary according to temperature.

Fig.31 shows an example of transition of charge capacity under several charge conditions.

【Charge characteristic (Charge characteristic)】

Mode	Current	Charge voltage	End of CV charge	Temperature
Charge	3.0mA	2.7V	0.15mA or 30 minutes	Each temperature

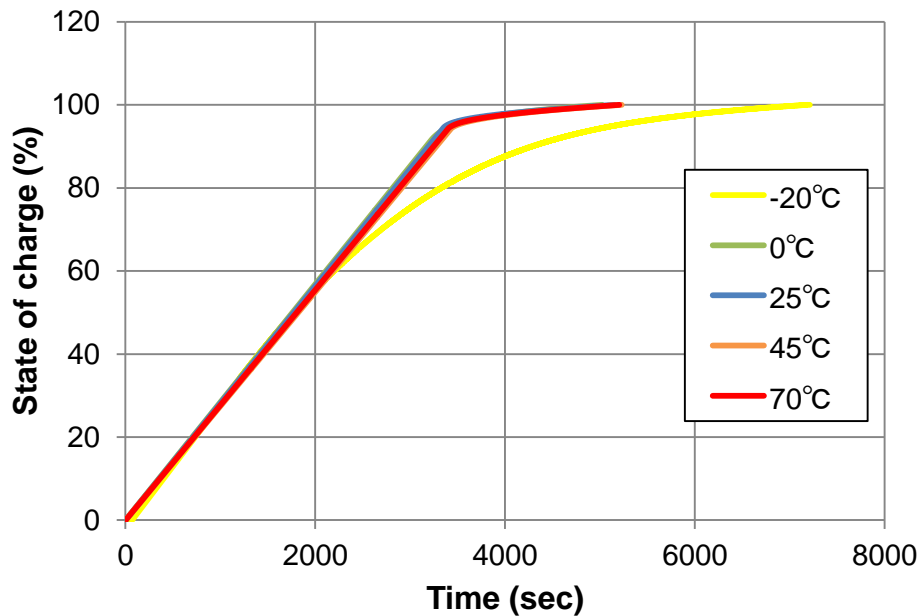

Fig.31: Relationship between temperature and charge capacity (UMAC040130A003TA01)

When battery temperature becomes low, internal resistance increases because moving speed of Li-ion in the electrolyte becomes slow. As a result, it takes more time to charge UMA series fully at low temperatures.

5.4.2 Discharge temperature characteristic

As is the case with charge characteristic, when battery temperature becomes low, internal resistance increases because moving speed of Li-ion in electrolyte becomes low. Then at low temperature battery voltage becomes low from the beginning of discharge. As a result, the overall discharge capacity becomes low because it is discharged to 1.8V (discharge cut-off voltage) earlier than at normal temperature.

Fig.32 and Fig. 33 shows an example of transition of discharge capacity under several charge conditions.

【Discharge characteristic (temperature characteristic)】

Mode	Current	Discharge cut-off voltage	Cut-off current	Temperature
Discharge	3.0mA / 24mA	1.8V	-	Each temperature

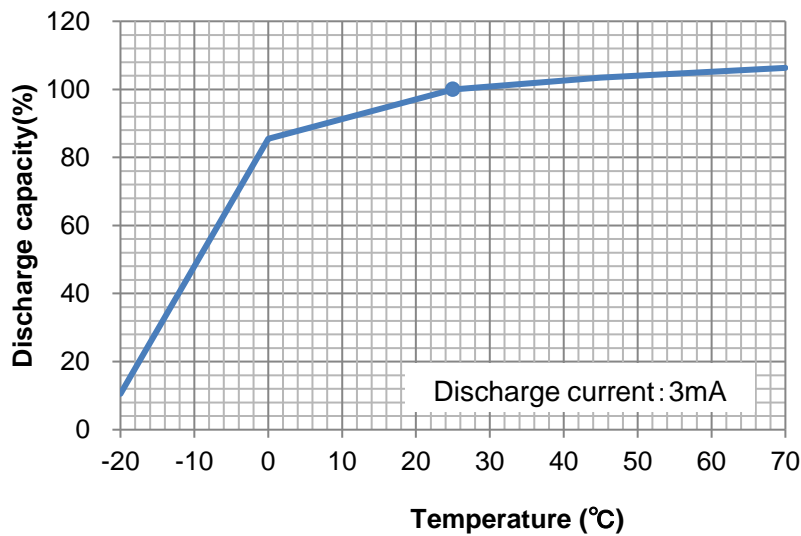

Fig.32: Relationship between temperature and discharge capacity (UMAC040130A003TA01)

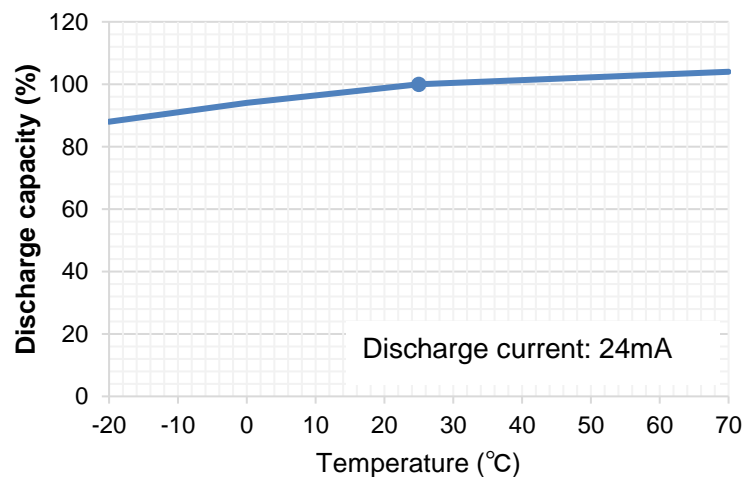

Fig. 33: Relationship between temperature and discharge capacity (UMAL361421B024TA01)

The discharge capacity (mAh) of UMAC040130A003TA01 at 3mA at 25°C decreases by about 17% at 0°C. The discharge capacity (mAh) of UMAL361421B024TA01 at 12mA at 25°C decreases by about 13% at 0°C.

5.5 Reliability

As explained in “1.4 Constituent materials of Murata’s lithium ion secondary battery”, because of using lithium titanate whose reaction potential of Li-ion absorption/desorption is relatively high, UMA series has low resistance, high temperature endurance, and excellent cycle characteristic.

In the following section, charge storage characteristic, discharge storage characteristic, load characteristic, and cycle characteristic are explained.

5.5.1 Charge storage characteristic

Charge storage characteristic shows battery performance after charged and stored for a long time without being connected to any load. There are two indexes: Charge(capacity) retention rate(%) and Charge(capacity) recovery rate(%).

Charge(capacity) retention rate(%) is how much capacity a battery can deliver after a period of storage of a fully charged battery without subsequent recharging as a percentage of the rated capacity.

Charge(capacity) recovery rate(%) is how much battery capacity recovers. It is obtained by comparing the initial capacity and the capacity when discharged to 1.8V after charged and stored. The capacity is measured at normal condition*2. In other words, charge(capacity) recovery rate(%) shows how a fully charged battery mounted in device deteriorates when stored for a long time without being connected to any load.

Fig. 34 to Fig.37 show charge(capacity) retention rate(%) and charge(capacity) recovery rate(%) of UMAC040130A003TA01 and UMAL361421B024TA01 after fully charged and stored for a certain period.

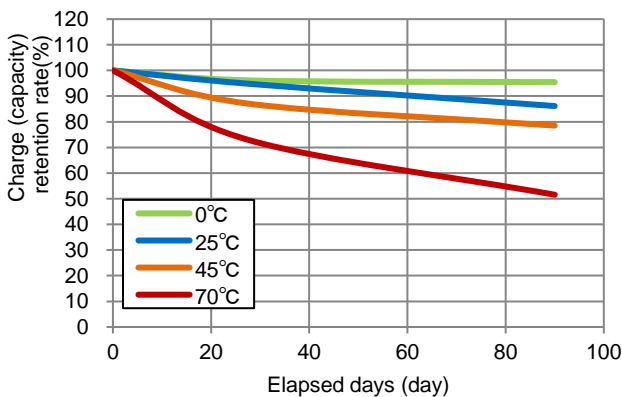

Fig. 34: Charge(capacity) retention rate (UMAC040130A003TA01)

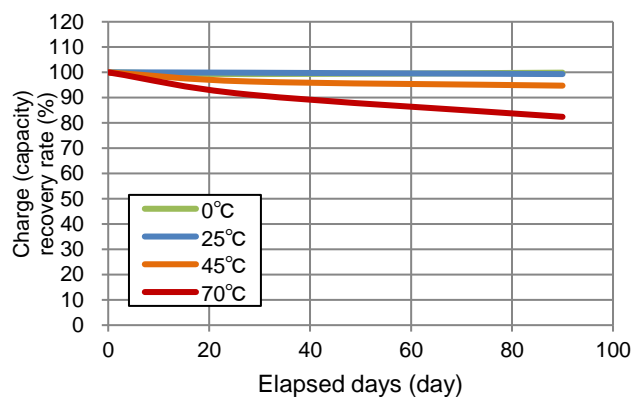

Fig. 35: Charge(capacity) recovery rate (UMAC040130A003TA01)

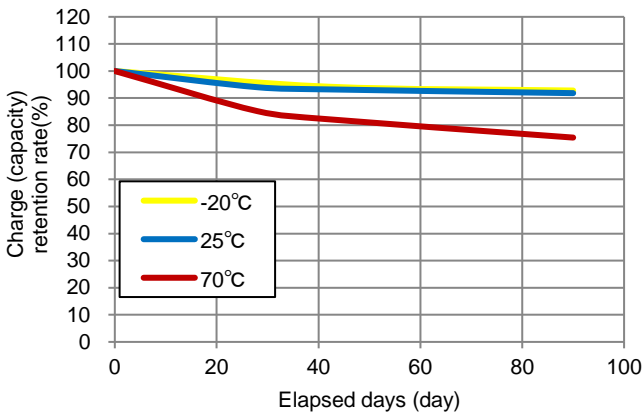

Fig. 36: Charge(capacity) retention rate (UMAL361421B024TA01)

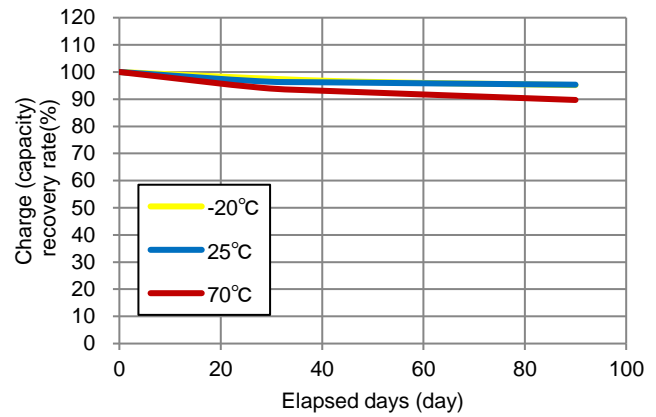

Fig. 37: Charge(capacity) recovery rate (UMAL361421B024TA01)

As temperature becomes low, both charge(capacity) retention rate(%) and charge(capacity) recovery rate tend to be higher. In the case of UMAC040130A003TA01, charge(capacity) retention rate(%) is 86% and charge(capacity) recovery rate is 99% after 90 days storage at 25°C. In the case of UMAL361421B024TA01, charge(capacity) retention rate(%) is 98% and charge(capacity) recovery rate is 100%. Even at high temperature UMA series shows excellent charge storage characteristic. After 90 days storage at 70°C, charge(capacity) retention rate(%) of UMAC040130A003TA01 is 51% and charge(capacity) recovery rate is 82%. Also, charge(capacity) retention rate(%) of UMAL361421B024TA01 is 75% and charge(capacity) recovery rate is 91%.

*2Normal condition of Measuring:

[Pretreatment]

<Discharge>Discharge down to 1.8V at 1CA/ Temp. : 25°C ⇒<Rest>30sec./Temp.:25°C

⇒ <Charge> CC Charge to 2.7V at 1CA. Then CV charge at 2.7V. CV charge end: until charge current becomes 0.05CA or after 30 minutes /Temp : 25°C ⇒ <Rest>30sec/Temp.:25°C

⇒[Measurement] <Discharge>Discharge down to 1.8V at 1CA/ Temp. : 25°C

5.5.2 Discharge storage characteristic

Discharge storage characteristic shows battery performance after discharged and stored for a long time without being connected to any load. The index is charge(capacity) recovery rate (%).

Charge(capacity) recovery rate is how much capacity a battery can deliver when charging after discharged and stored for a certain period as a percentage of the rated capacity. The capacity is measured at normal condition^{*2}. Charge(capacity) recovery rate shows how a discharged battery mounted in device deteriorates when stored for a long time without being connected to any load.

Fig.38 and Fig. 39 show a charge(capacity) recovery rate(%) of UMA series after discharged and stored for a certain period.

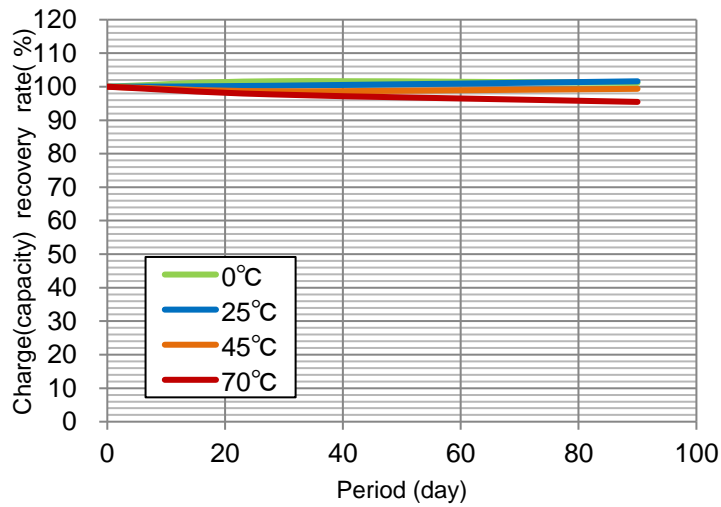

Fig.38: Charge(capacity) recovery rate(%) (UMAC040130A003TA01)

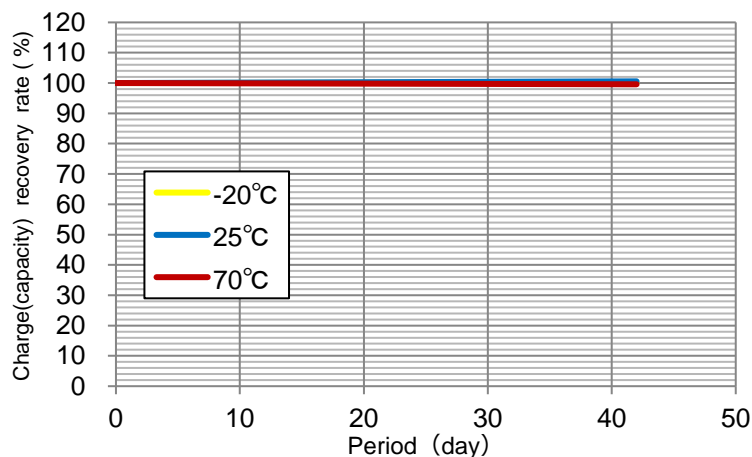

Fig. 39: Charge(capacity) recovery rate(%) (UMAL361421B024TA01)

As shown in Fig.38, After 90 days storage at 25°C, charge(capacity) recovery rate(%) of UMAC040130A003TA01 is 100% and it is 95% even at 70°C. As shown in Fig. 39, after 42days storage at 25°C, charge(capacity) recovery rate(%) of UMAL361421B024TA01 is 100% and it is still 100% even at 70°C. Thus UMA series has excellent discharge storage characteristic.

5.5.3 Load characteristic

Load characteristic shows battery performance after continuously applying load by keeping charge voltage of 2.7V. The index is capacity ratio(%) versus initial capacity.

It shows how much capacity a battery can keep after loading test when charging battery under the same condition as a percentage of the initial capacity. The capacity is measured at normal condition*2. For example, you can see how battery deteriorates after fully charged and being connected to load when using battery for backup applications.

Fig.40 and Fig. 41 shows a capacity ratio (%) of UMAC040130A003TA01 and UMAL361421B024TA01 after continuously applying charge voltage of 2.7V.

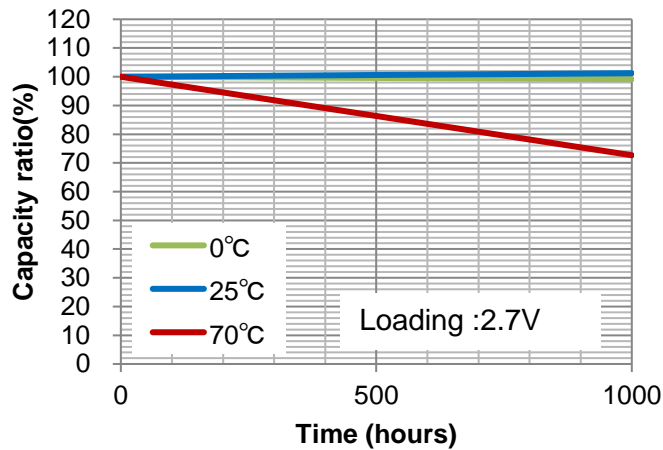

Fig.40: Capacity ratio after applying charge voltage(2.7V) continuously (UMAC040130A003TA01)

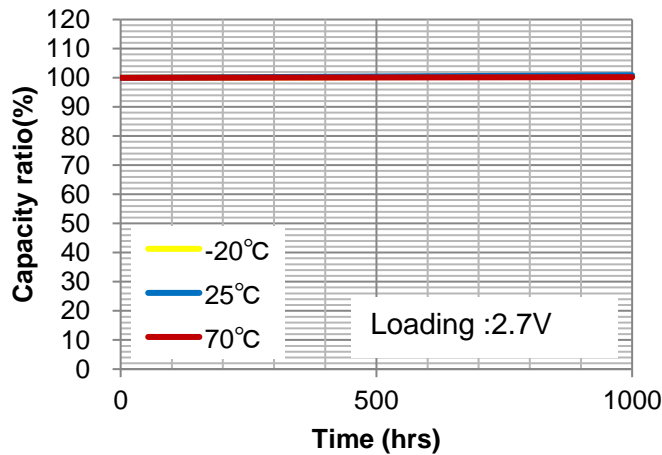

Fig. 41 Capacity ratio after applying charge voltage(2.7V) continuously (UMAL361421B024TA01)

As shown in Fig.40, after applying voltage continuously at 25°C, capacity ratio (%) of UMAC040130A003TA01 is 99% and it is 71% even at 70°C. Similarly, as shown in Fig. 41, after applying voltage continuously at 25°C, capacity ratio(%) of UMAL361421B024TA01 is 99% and it is still 99% even at 70°C. Thus, UMA series has excellent load characteristic. However please note that the higher the temperature is, the more reactive the electrode materials become. As a result, the capacity ratio becomes lower because side reaction occurs on electrodes. For long-term use at high temperature, this point should be considered.

5.5.4 Cycle characteristic

Cycle characteristic means how much a battery can keep its performance after repeating charge-discharge cycles. The index is capacity ratio(%) versus initial capacity.

It shows how much capacity a battery can keep after the cycle test when charging battery under the same condition as a percentage of the initial capacity. The capacity is measured at normal condition². Fig. 42 shows a capacity ratio(%)of UMAC040130A003TA01 after cycle test at 100mA(quick charge).

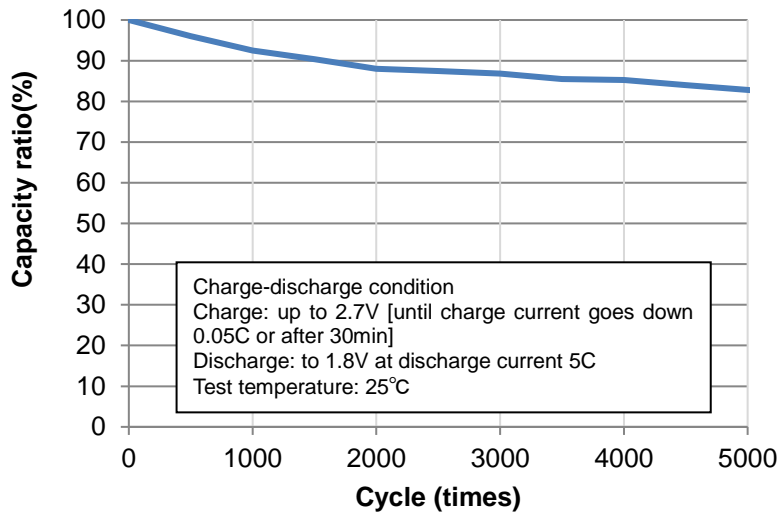

Fig. 42: Capacity ratio (%) of UMAC040130A003TA01 after cycle test at 100mA(Quick charge)

As shown in Fig. 42, UMAC040130A003TA01 has excellent cycle characteristics. After 1500 cycles at 25°C, capacity ratio (%) is over 90%.

Fig. 43 shows the capacity ratio of UMAL when charging UMAL361421B024TA01 cyclically by CV charge (Max.1200mA, 2.7V, Until charge current goes down 0.60mA or after 30min.).

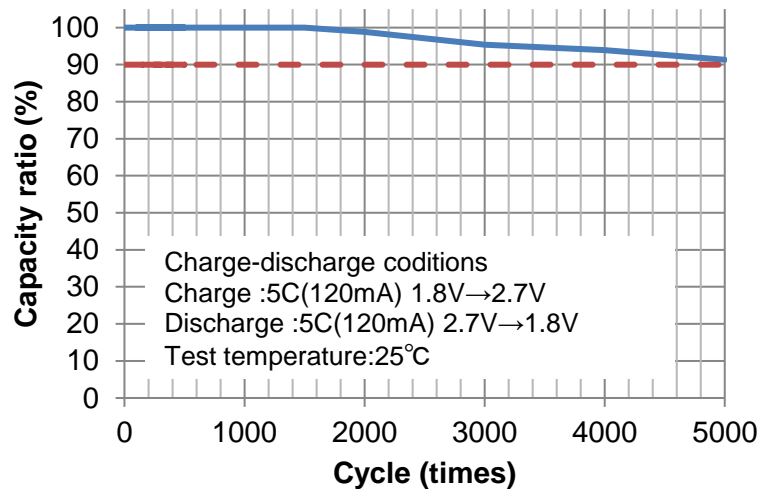

Fig. 43 Capacity ratio of CV charge cycle(%) (UMAL361421B024TA01)

As shown in Fig. 43, UMAL361421B024TA01 has also excellent cycle characteristics. After 2000 cycles at 25°C, capacity ratio (%) is 99%.

6. Safety

6.1 High safety design of UMA series

In UMA series, lithium titanate is used as active material for the negative electrode. As explained in “1.4 Constituent materials of Murata’s lithium ion secondary battery”, UMA series has high safety by using high safety materials. In fact, it passed various safety tests such as external short circuit test or abnormal charge test.

6.2 Safety standard of UMA Series

UMA series received the safety standard, UL1642 and IEC62133 certification.

The safety of UMA series is adequately checked by performing many safety tests in reference to safety standard, UL1642 certification.

Table 4 Safety test items of UMA series

No	Item	Characteristics	Test Condition
1	Short-Circuit Test	The samples shall not explode or catch fire. Case surface temperature shall not exceed 150°C.	<ul style="list-style-type: none"> ✓ Each fully charged battery, in turn, is to be short-circuited by connecting the positive and negative terminals of the battery with a circuit load having a resistance load of 80 ±20 mohm. ✓ The temperature of the battery case is to be recorded during the test. The battery is to discharge until a fire or explosion is obtained, or until it has reached a completely discharged state of less than 0.2 V and the battery case temperature has returned to ±10°C of ambient temperature. ✓ Tests are to be conducted at 20±5°C and at 55 ±5°C.
2	Abnormal Charging Test	The samples shall not explode or catch fire.	<ul style="list-style-type: none"> ✓ The batteries are to be tested in an ambient temperature of 20±5°C. Each test sample battery is to be discharged at a constant current of 0.2 CA, to Murata specified cut-off voltage ^{(*)3}. ✓ The cell or battery is then to be charged with a constant maximum specified output voltage ^{(*)3} and a current limit of three times the maximum charging current ^{(*)3}, specified by Murata. Charging duration is to be 7 h or the time required to reach Murata’s specified end-of-charge condition ^{(*)4}, whichever is greater.
3	Forced-Discharge Test	The samples shall not explode or catch fire.	<ul style="list-style-type: none"> ✓ A fully discharged cell is to be force-discharged by connecting it in series with fully charged cells of the same kind. Cells are to be fully discharged, at room temperature. ✓ Once the fully discharged cell is connected in series with the specified number of fully charged cells the resultant battery pack is to be short circuited. ✓ The positive and negative terminals of the sample are to be connected with a resistance load of 80±20 mohm. The sample is to discharge until a fire or explosion is obtained, or until it has reached a completely discharged state of less than 0.2 V and the battery case temperature has returned to ±10°C of ambient temperature.

No	Item	Characteristics	Test Condition
4	Crush Test	The samples shall not explode or catch fire.	<ul style="list-style-type: none"> ✓ A fully charged battery is to be crushed between two flat surfaces. The force for the crushing is to be applied by a hydraulic ram or similar force mechanism. The flat surfaces are to be brought in contact with the cells and the crushing is to be continued until an applied force of 13±1 kN is reached. Once the maximum force has been obtained it is to be released. ✓ For lithium ion systems, a cylindrical cell is to be crushed with its longitudinal axis parallel to the flat surfaces of the crushing apparatus. Each sample is to be subjected to a crushing force in only one direction. Cells shall be tested at a temperature of 20±5°C.
5	Impact Test	The samples shall not explode or catch fire.	<ul style="list-style-type: none"> ✓ A fully charged battery is to be placed on a flat surface. A 15.8±0.1 mm diameter bar is to be placed across the center of the sample. A 9.1 ±0.46 kg weight is to be dropped from a height of 610±25 mm onto the sample. ✓ Cells shall be tested at a temperature of 20 ±5°C.
6	Shock Test	The samples shall not explode or catch fire and shall not vent or leak.	<ul style="list-style-type: none"> ✓ The fully charged cell shall be tested at a temperature of 20±5°C. ✓ The shocks are to be applied in each of three mutually perpendicular directions. For each shock the cell is to be accelerated in such a manner that during the initial 3 ms the minimum average acceleration is 75 G. ✓ The peak acceleration shall be between 125 and 175 G.
7	Vibration Test	The samples shall not explode or catch fire and shall not vent or leak.	<ul style="list-style-type: none"> ✓ A fully charged battery is to be subjected to simple harmonic motion with amplitude of 0.8 mm [1.6mm total maximum excursion]. ✓ The frequency is to be varied at the rate of 1 Hz/min between 10 and 55 Hz, and return in not less than 90 nor more than 100 min. The battery is to be tested in three mutually perpendicular directions.
8	Low Pressure Test	The samples shall not explode or catch fire and shall not vent or leak.	<ul style="list-style-type: none"> ✓ Fully charged batteries are to be stored for 6 hours at an absolute pressure of 11.6 kPa and a temperature of 20±3°C.
9	Projectile Test	No part of an exploding cell or battery shall penetrate the wire screen such that some or all of the cell or battery protrudes through the screen.	<ul style="list-style-type: none"> ✓ Fully charged cell or battery is to be placed on a screen that covers a 102-mm diameter hole in the center of a platform table. The screen is to be mounted 38 mm (1-1/2 in) above a burner. The sample is to be heated and shall remain on the screen until it explodes or the cell or battery has ignited and burned out.

No	Item	Characteristics	Test Condition
10	Heating Test	The samples shall not explode or catch fire.	✓ A fully charged battery is to be heated in a gravity convection or circulating air oven with an initial temperature of 20±5°C. The temperature of the oven is to be raised at a rate of 5±2°C per minute to a temperature of 130±2°C and remain for 10 min. The sample shall return to room temperature (20±5°C) and then be examined.
11	Temperature Cycling Test	The samples shall not explode or catch fire and shall not vent or leak.	The fully charged batteries are to be placed in a test chamber and subjected to the following cycles: ✓ Raising the chamber-temperature to 70±3°C within 30 min and maintaining this temperature for 4 h. ✓ Reducing the chamber temperature to 20±3°C within 30 min and maintaining this temperature for 2 h. ✓ Reducing the chamber temperature to minus 40 ±3°C within 30 min and maintaining this temperature for 4 h. ✓ Raising the chamber temperature to 20±3°C within 30 min. ✓ Repeating the sequence for a further 9 cycles. ✓ After the 10th cycle, storing the batteries for a minimum of 24 h, at a temperature of 20±5°C prior to examination.

(³) Murata specified cut-off voltage is minimum voltage of operating voltage range. Maximum specified output voltage is maximum voltage of operating voltage range. Please refer to operating voltage range and Max. Charge Current (Table 1 and Table 2).
 (⁴) Murata specified end-of-charge condition is when the charge current would reach <0.05CA.

Murata has also conducted safety tests based on “United Nations Recommendations on the Transport of Dangerous Goods (UN38.1)”. Fig. 44 shows the result of external short circuit test on UMAL361421B024TA01.

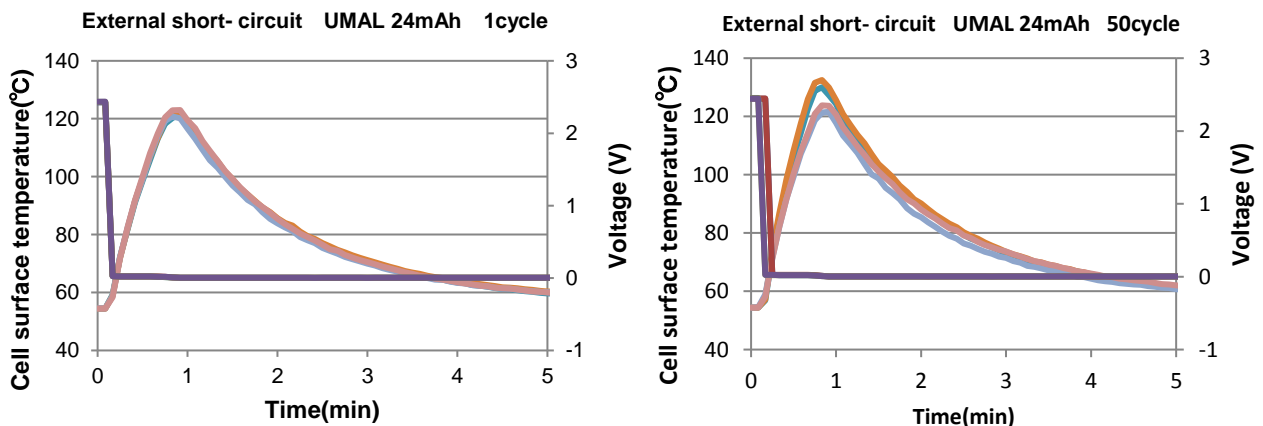

<Judgment criteria>

Surface temperature does not exceed 170°C.

No rupture, no disassembly and no ignition occurs during the test or within 6 hours after the test.

<Result>

Pretreatment	Number of samples	During the test or within 6 hours after the test			Surface temperature 170°C or less
		Rupture	Disassembly	Ignition	
1st cycle	6	G	G	G	G
50th cycle	6	G	G	G	G

Fig. 44 Result of the external circuit test (“United Nations Recommendations on the Transport of Dangerous Good. UN38.4) (UMAL361421B024TA01)

7. Caution for Use

7.1 Limitation of Applications

Please contact us before using our products for the applications listed below which may require especially high reliability for the prevention of defects which might directly cause damage to the end-users' life, body or property.

- ①Aircraft equipment ②Aerospace equipment ③Undersea equipment
- ④Power plant control equipment ⑤Medical equipment
- ⑥Transportation equipment(vehicles, trains, ships, etc.) ⑦Traffic signal equipment
- ⑧Disaster prevention / crime prevention equipment ⑨Data-processing equipment ⑩Vehicles
- ⑪Application of similar complexity and/or reliability requirements to the applications listed in above.

Please do not use this product for any applications related to the following.

- ①Military equipment

7.2 Storage Condition

7.2.1 Storage conditions before opening the packaging

Term of warranty for this product is 6 months after packaging under the conditions below with sealed package.

Recommended storage environment: Room temperature: 30 °C

Humidity: No more than 60%RH

This product cannot be baked

7.2.2 Storage conditions after opening the packaging.

(1) Term of warranty of this product is 3 months after opening sealed package.

(2) Please keep product under the following conditions in sealed package.

Temperature: 5-35°C

Humidity: No more than 70%RH. No condensation.

Avoid any acidic or alkaline environment.

Avoid excessive external force on this product while in storage.

(3)Please keep product in sealed packaging before use.

7.3. Cautions for design

(1) Operating voltage range

This product should be used within specified operating voltage range. If it is used with voltage out of the range, deformation or leakage may occur. Please do not short circuit the positive and negative terminals. It may cause product deformation or leakage.

(2) Polarity

This product has a polarity. Please do not reverse the polarity when in use. Reverse polarity may damage electrolyte or the electrode inside. Please verify the orientation of the device before use.

(3) Self heating temperature

When repeating charge and discharge in a short cycle, self heating is generated by internal resistance.

The product temperature should not exceed 70°C, including any self heating.

(4) This product cannot be used under any acidic or alkaline environment.

(5) At extremely low pressure, this product may not be able to provide expected performance. If you would like to use this product at low pressure environment continuously, please consult us first.

(6) Charge voltage

In order to charge this product up to 80% of full capacity, it should be charged at a voltage between 2.45V and 2.7V (charge voltage).

7.4. Soldering and Assembling

(1) Reflow and flow soldering cannot be used because product body temperature will rise beyond maximum allowable temperature. Please use other mounting methods. These may include hand soldering, connector mounting, etc.

(2) Please do not apply excessive force to the product during insertion as well as after soldering. The excessive force may result in damage to electrode terminals and/or degradation of electrical performance.

(3) Manual Soldering

The following conditions are recommended;

Solder Type: Resin flux cored solder wire (ϕ 1.2mm)

Solder: Lead-free solder: Sn-3Ag-0.5Cu

Soldering iron temperature: 350 °C \pm 10 °C

Solder Iron wattage: 70W max.

Soldering time: 3~4 sec per one terminal

Allowable soldering frequencies: 2 times maximum per one terminal.

Allowable cumulative soldering time per device: 20 sec max total.

- i. Please do not touch product body directly by solder iron.
- ii. <UMAC only> If terminals are vended after soldering, the product may break if excessive force is applied to the edge of terminals. Therefore please vend terminals before soldering without applying excessive force to the edge of terminals.
- iii. <UMAL only> Do not vend the terminals. The product may break if excessive force is applied to the terminals

- (4) Please do not wash the device after soldering.
- (5) <UMAC only> Please insulate the area where the product body becomes in contact with other parts in order to prevent electrical contact.
(e.g.) Resist coating on the circuit board (Fig. 45)

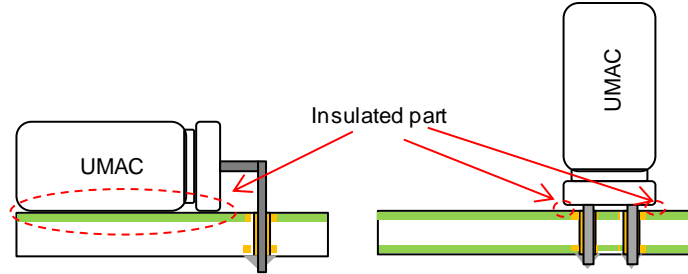

Fig. 45: Resist coating

7.5 Resin Coating

If coating/molding the device with resin, there is a risk that some resins may erode metal, or cure-stress of resin may distort terminal or package shape. Therefore please pay careful attention in selecting resin. Prior to use, please make the reliability evaluation with the device mounted in your set.

7.6 Disassembly

Please do not disassemble this product. It may cause electrolyte leakage or failure.

7.7 Disposal

This device should be disposed of as industrial waste in accordance with local laws and regulations. Never throw this device into fire.

7.8 Air transportation

Murata's lithium ion battery is proven to meet the requirements of each test in the UN Manual of tests and Criteria, Part III, sub-section 38.3. Therefore, in the case of air transportation, the packing standard of the Section II of PI965 (Packing Instruction 965) IATA dangerous materials rule (IATA-DGR) is applied. Please consult with us when air transportation is needed.



Fig. 46: UN caution label

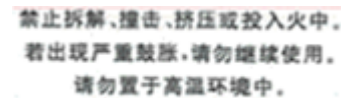

Fig. 47: China caution label

7.9 Return of damaged or defective products

Air transportation of damaged or defective lithium ion battery is strictly prohibited by the IATA Dangerous Goods Regulations. Please consult with us in advance when returning the product.

7.10 Recycle

(Japan)

Lithium-Ion batteries can be recycled. Please bring redundant batteries to a partner company to support the recycling of rechargeable batteries. We are affiliated with JBRC(Japan Portable Rechargeable Battery Recycle Center) and conduct recycling activities. We would be grateful for your cooperation in the recycling of redundant rechargeable battery.

Please visit JBRC website to confirm a partner company to support recycling rechargeable batteries.

<http://www.jbrc.com/>

(Outside of Japan)

Lithium-Ion batteries can be recycled. Regulations and laws related to the recycling of lithium ion batteries vary from country to country as well as by state and local governments. Please check the laws and regulations of the products' final use areas.