

# BLF4G22-130; BLF4G22LS-130

UHF power LDMOS transistor

Rev. 01 — 3 July 2007

Product data sheet

## 1. Product profile

### 1.1 General description

130 W LDMOS power transistor for base station applications at frequencies from 2000 MHz to 2200 MHz.

**Table 1. Typical performance**

*T<sub>case</sub> = 25 °C in a common source class-AB test circuit.*

Mode of operation	f (MHz)	V <sub>DS</sub> (V)	P <sub>L(AV)</sub> (W)	G <sub>p</sub> (dB)	η <sub>D</sub> (%)	IMD3 (dBc)	ACPR (dBc)
2-carrier W-CDMA <sup>[1]</sup>	f <sub>1</sub> = 2135; f <sub>2</sub> = 2145	28	33	13.5	26	-37	-41

[1] 10 MHz carrier spacing PAR 7 dB at 0.01 % probability on CCDF, 3GPP test model 1, 1 - 64 DPCH.

#### CAUTION



This device is sensitive to ElectroStatic Discharge (ESD). Therefore care should be taken during transport and handling.

### 1.2 Features

- Typical 2-carrier W-CDMA performance at a supply voltage of 28 V and an I<sub>DQ</sub> of 1150 mA:
  - ◆ Average output power = 33 W
  - ◆ Power gain = 13.8 dB
  - ◆ Efficiency = 26 %
  - ◆ ACPR = -41 dBc
  - ◆ IMD3 = -37 dBc
- Easy power control
- Integrated ESD protection
- Excellent ruggedness (> 10 : 1 VSWR at 130 W (CW))
- High efficiency
- High peak power capability (> 190 W)
- Excellent thermal stability
- Designed for broadband operation (2000 MHz to 2200 MHz)
- Internally matched for ease of use

## 1.3 Applications

- RF power amplifiers for W-CDMA base stations and multi carrier applications in the 2000 MHz to 2200 MHz frequency range.

## 2. Pinning information

**Table 2. Pinning**

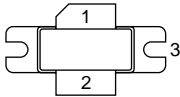
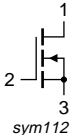
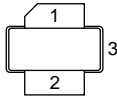
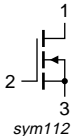
Pin	Description	Simplified outline	Symbol
<b>BLF4G22-130 (SOT502A)</b>			
1	drain		 sym112
2	gate		
3	source		
<b>BLF4G22LS-130 (SOT502B)</b>			
1	drain		 sym112
2	gate		
3	source		

[1] Connected to flange

## 3. Ordering information

**Table 3. Ordering information**

Type number	Package		
	Name	Description	Version
BLF4G22-130	-	flanged LDMOST ceramic package; 2 mounting holes; 2 leads	SOT502A
BLF4G22LS-130	-	earless flanged LDMOST ceramic package; 2 leads	SOT502B

## 4. Limiting values

**Table 4. Limiting values**

In accordance with the Absolute Maximum Rating System (IEC 60134).

Symbol	Parameter	Conditions	Min	Max	Unit
$V_{DS}$	drain-source voltage		-	65	V
$V_{GS}$	gate-source voltage		-0.5	+15	V
$I_D$	drain current		-	15	A
$T_{stg}$	storage temperature		-65	+150	°C
$T_j$	junction temperature		-	200	°C

## 5. Thermal characteristics

**Table 5: Thermal characteristics**

Symbol	Parameter	Conditions	Type	Typ	Max	Unit
$R_{th(j-case)}$	thermal resistance from junction to case	$T_{case} = 80\text{ °C};$ $P_L = 33\text{ W}$	BLF4G22-130	0.56	0.65	K/W
			BLF4G22LS-130	0.50	0.59	K/W

## 6. Characteristics

**Table 6. Characteristics**

$T_j = 25\text{ °C}$  unless otherwise specified

Symbol	Parameter	Conditions	Min	Typ	Max	Unit
$V_{(BR)DSS}$	drain-source breakdown voltage	$V_{GS} = 0\text{ V}; I_D = 2.1\text{ mA}$	65	-	-	V
$V_{GS(th)}$	gate-source threshold voltage	$V_{DS} = 10\text{ V}; I_D = 230\text{ mA}$	2.5	3.1	3.5	V
$I_{DSS}$	drain leakage current	$V_{GS} = 0\text{ V}; V_{DS} = 28\text{ V}$	-	-	5	$\mu\text{A}$
$I_{DSX}$	drain cut-off current	$V_{GS} = V_{GS(th)} + 6\text{ V};$ $V_{DS} = 10\text{ V}$	35	44	-	A
$I_{GSS}$	gate leakage current	$V_{GS} = +15\text{ V}; V_{DS} = 0\text{ V}$	-	-	420	nA
$g_{fs}$	forward transconductance	$V_{DS} = 10\text{ V}; I_D = 12.8\text{ A}$	-	11	-	S
$R_{DS(on)}$	drain-source on-state resistance	$V_{GS} = V_{GS(th)} + 6\text{ V};$ $I_D = 7.7\text{ A}$	-	0.07	-	$\Omega$
$C_{rs}$	feedback capacitance	$V_{GS} = 0\text{ V}; V_{DS} = 28\text{ V};$ $f = 1\text{ MHz}$	-	3.4	-	pF

## 7. Application information

**Table 7. Application information**

Mode of operation: 2-carrier W-CDMA, PAR 7 dB at 0.01 % probability on CCDF, 3GPP test model 1, 1-64 DPCH;  $f_1 = 2112.5\text{ MHz}; f_2 = 2122.5\text{ MHz}; f_3 = 2157.5\text{ MHz}; f_4 = 2167.5\text{ MHz}.$

Symbol	Parameter	Conditions	Min	Typ	Max	Unit
$G_p$	power gain	$P_{L(AV)} = 33\text{ W}$	12.5	13.5	-	dB
$RL_{in}$	input return loss	$P_{L(AV)} = 33\text{ W}$	-9	-15	-	dB
$\eta_D$	drain efficiency	$P_{L(AV)} = 33\text{ W}$	24	26	-	%
IMD3	third order intermodulation distortion	$P_{L(AV)} = 33\text{ W}$	-	-37	-34	dBc
ACPR	adjacent channel power ratio	$P_{L(AV)} = 33\text{ W}$	-	-41	-39	dBc

### 7.1 Ruggedness in class-AB operation

The BLF4G22-130 and the BLF4G22LS-130 are capable of withstanding a load mismatch corresponding to VSWR = 10 : 1 through all phases under the following conditions:  $V_{DS} = 28\text{ V}; I_{Dq} = 1150\text{ mA}; P_L = 130\text{ W (CW)}.$

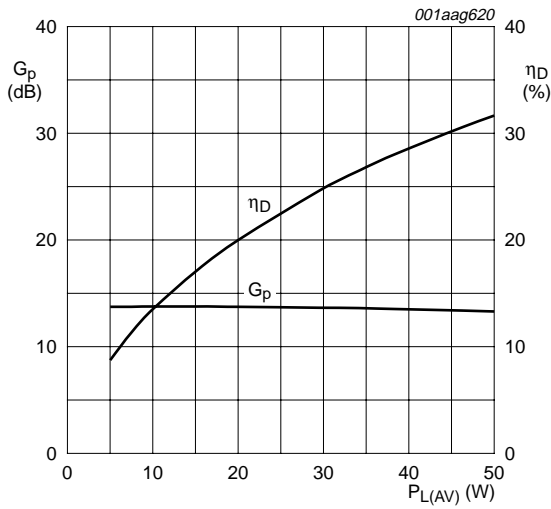

$V_{DS} = 28\text{ V}$ ;  $I_{DQ} = 900\text{ mA}$ ;  $T_{case} = 25\text{ }^\circ\text{C}$ ;  
 $f = 1990\text{ MHz}$ .

**Fig 1. 2-Carrier W-CDMA power gain and drain efficiency as functions of average load power; typical values**

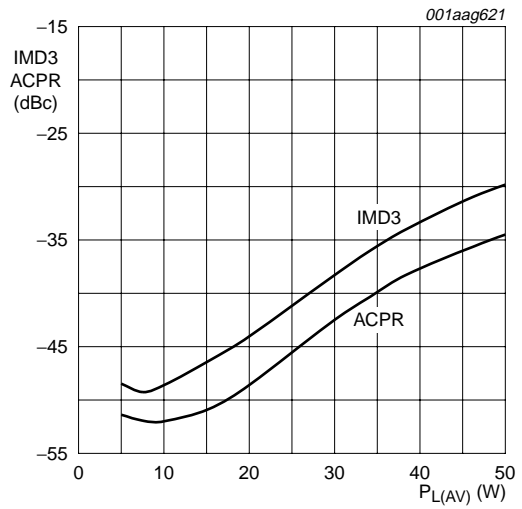

$V_{DS} = 28\text{ V}$ ;  $I_{DQ} = 900\text{ mA}$ ;  $T_{case} = 25\text{ }^\circ\text{C}$ ;  
 $f = 1990\text{ MHz}$ .

**Fig 2. 2-Carrier W-CDMA IMD3 and ACPR as functions of average load power; typical values**

**Table 8. Typical impedance**

$V_{DS} = 28\text{ V}$ ;  $I_{DQ} = 1150\text{ mA}$ ;  $P_{L(AV)} = 33\text{ W}$ ;  $T_{case} = 25\text{ }^\circ\text{C}$ .

f	$Z_S$	$Z_L$
MHz	$\Omega$	$\Omega$
2110	1.9 – j2.8	1.7 – j1.8
2140	1.8 – j2.7	1.6 – j1.6
2170	1.7 – j2.6	1.5 – j1.4

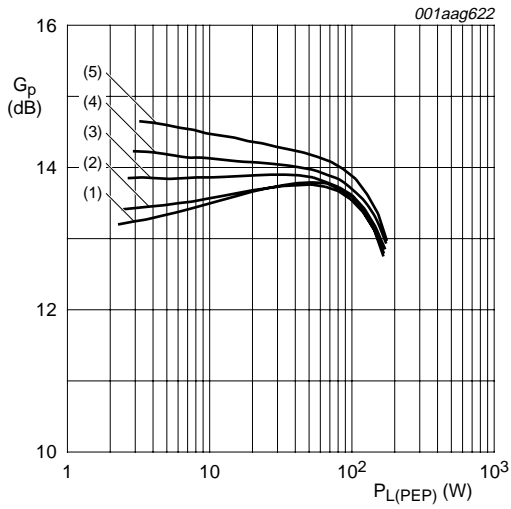

(1)  $I_{Dq} = 850 \text{ mA}$   
 (2)  $I_{Dq} = 975 \text{ mA}$   
 (3)  $I_{Dq} = 1150 \text{ mA}$   
 (4)  $I_{Dq} = 1350 \text{ mA}$   
 (5)  $I_{Dq} = 1550 \text{ mA}$   
 $V_{DS} = 28 \text{ V}; f_1 = 2140.0 \text{ MHz}; f_2 = 2140.1 \text{ MHz}.$

**Fig 3. Two-tone power gain as a function of peak envelope load power; typical values**

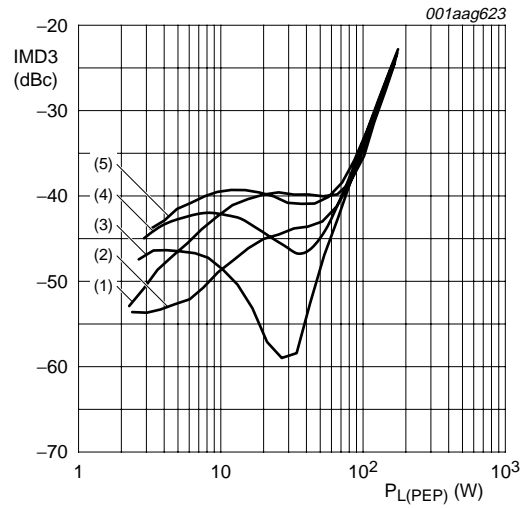

(1)  $I_{Dq} = 850 \text{ mA}$   
 (2)  $I_{Dq} = 975 \text{ mA}$   
 (3)  $I_{Dq} = 1150 \text{ mA}$   
 (4)  $I_{Dq} = 1350 \text{ mA}$   
 (5)  $I_{Dq} = 1550 \text{ mA}$   
 $V_{DS} = 28 \text{ V}; f_1 = 2140.0 \text{ MHz}; f_2 = 2140.1 \text{ MHz}.$

**Fig 4. Third order intermodulation distortion as a function of peak envelope load power; typical values**

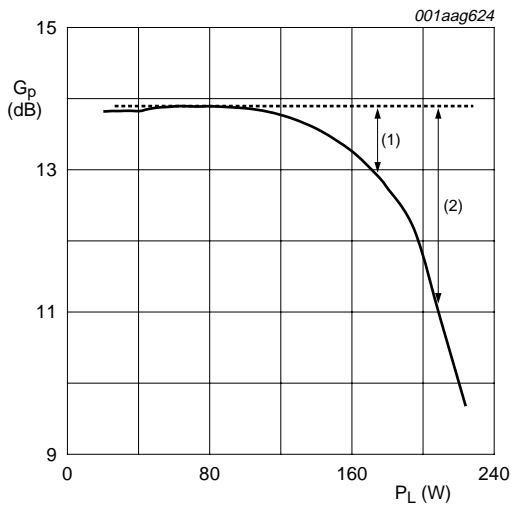

$t_{on} = 8 \mu\text{s}; t_{off} = 1 \text{ ms}.$   
 (1)  $P_{L(1dB)} = 174 \text{ W} (= 52.4 \text{ dBm})$   
 (2)  $P_{L(3db)} = 209 \text{ W} (= 53.2 \text{ dBm})$

**Fig 5. Pulsed peak power capability; typical values**

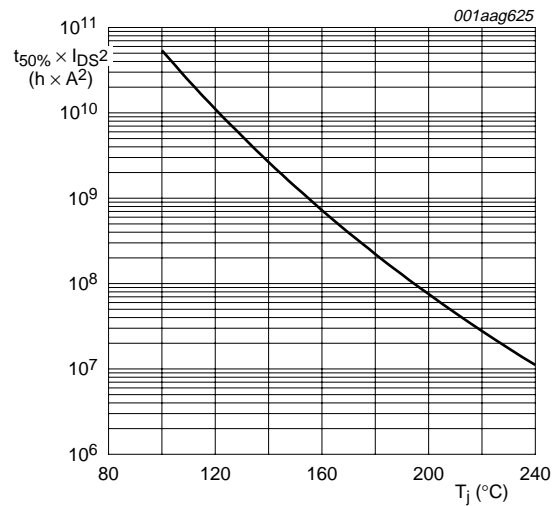

**Fig 6. Time in hours to 50 % cumulative failure ( $t_{50\%}$ ) due to electromigration as function of junction temperature**

8. Test information

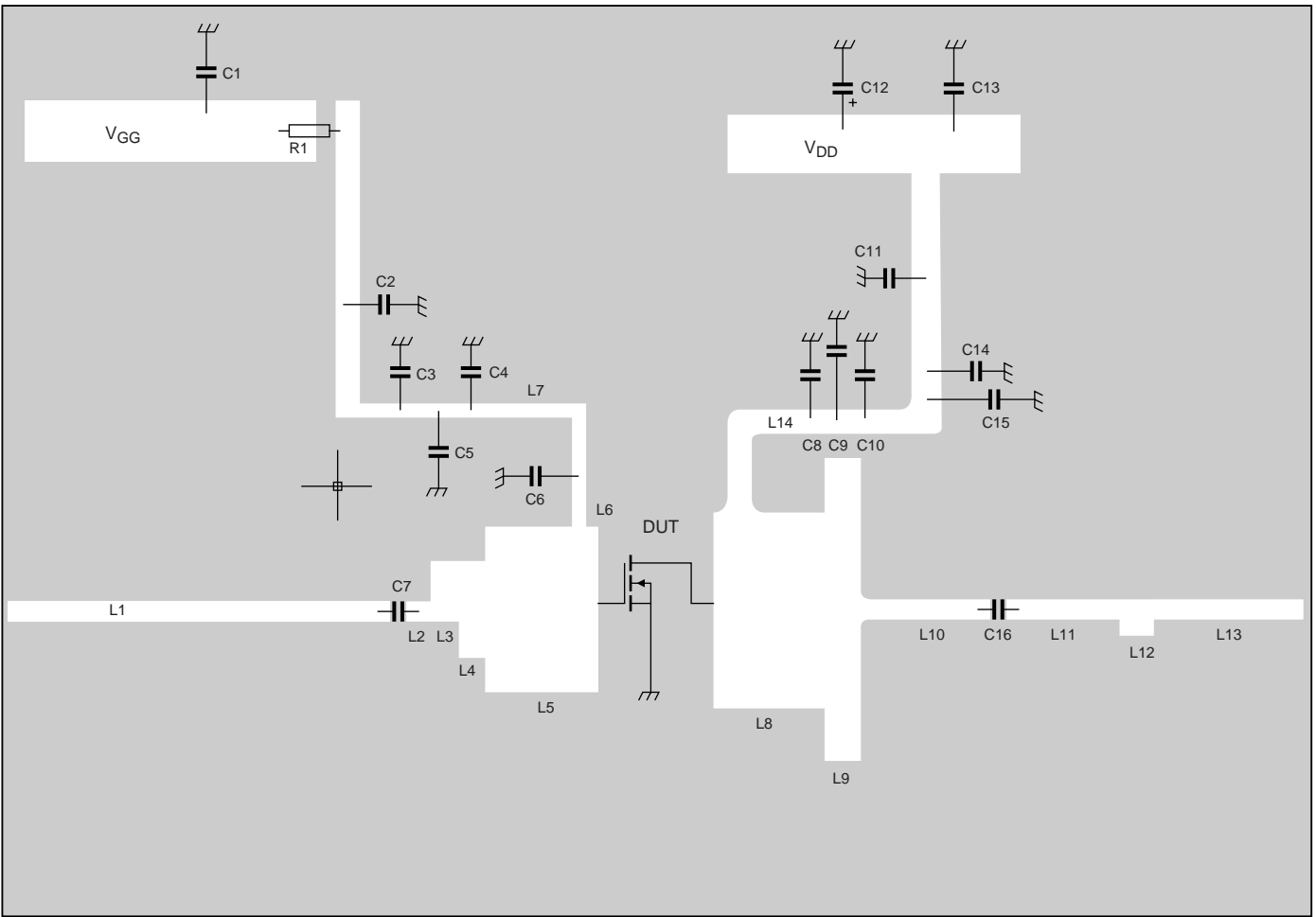

001aac275

See [Table 9](#) for list of components.

**Fig 7. Schematic test circuit for operation at 2.14 GHz**

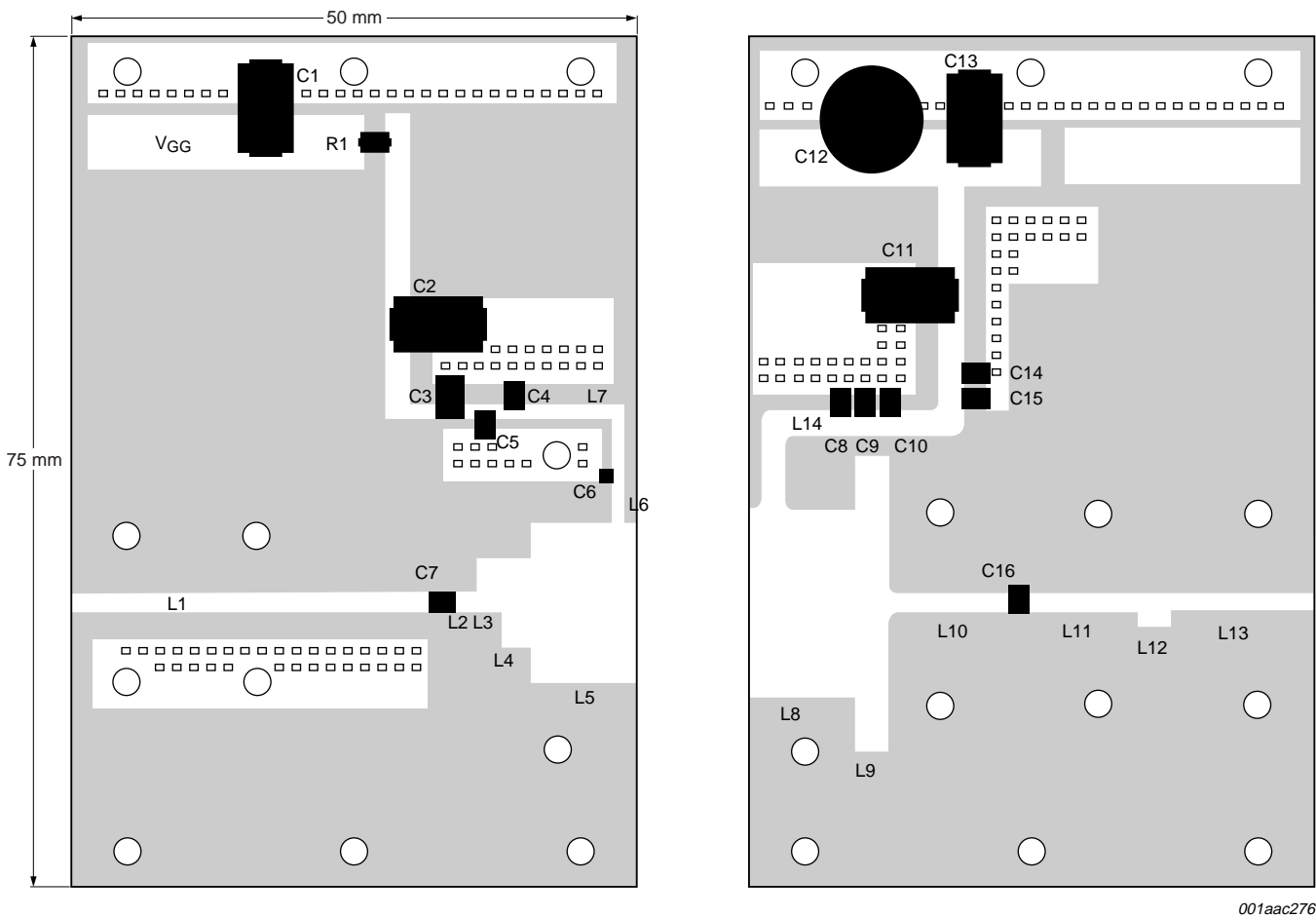

The components are situated on a double copper-clad Taconic RF35 Printed-Circuit Board (PCB) ( $\epsilon_r = 3.5$ ); thickness = 0.76 mm. The other side is unetched and serves as a ground plane.

See [Table 9](#) for list of components.

**Fig 8. Component layout for 2.14 GHz test circuit**

Table 9. List of components (see Figure 7 and Figure 8)

Component	Description	Value	Remarks
C1, C2, C11	tantalum capacitor	10 $\mu$ F; 35 V	
C3	multilayer ceramic chip capacitor	4.7 $\mu$ F; 25 V	
C4, C10	multilayer ceramic chip capacitor	8.2 pF	[2]
C5, C8, C14, C15	multilayer ceramic chip capacitor	1.5 $\mu$ F; 50 V	
C6	multilayer ceramic chip capacitor	0.6 pF	[1]
C7	multilayer ceramic chip capacitor	4.7 pF	[2]
C9	multilayer ceramic chip capacitor	220 nF; 50 V	
C12	electrolytic capacitor	220 $\mu$ F; 63 V	
C13	tantalum capacitor	4.7 $\mu$ F; 50 V	
C16	multilayer ceramic chip capacitor	7.5 pF	[1] ATC180R
L1	stripline	$Z_0 = 50 \Omega$	[3] (W $\times$ L) 32.3 mm $\times$ 1.7 mm
L2	stripline	$Z_0 = 50 \Omega$	[3] (W $\times$ L) 2.2 mm $\times$ 1.7 mm
L3	stripline	$Z_0 = 24 \Omega$	[3] (W $\times$ L) 2.3 mm $\times$ 4.8 mm
L4	stripline	$Z_0 = 15 \Omega$	[3] (W $\times$ L) 2.4 mm $\times$ 8 mm
L5	stripline	$Z_0 = 9.5 \Omega$	[3] (W $\times$ L) 9.3 mm $\times$ 14 mm
L6	stripline	$Z_0 = 60 \Omega$	[3] (W $\times$ L) 4 mm $\times$ 1.2 mm
L7	stripline	$Z_0 = 60 \Omega$	[3] (W $\times$ L) 14.5 mm $\times$ 1.2 mm
L8	stripline	$Z_0 = 8.2 \Omega$	[3] (W $\times$ L) 9.3 mm $\times$ 16.8 mm
L9	stripline	$Z_0 = 5.5 \Omega$	[3] (W $\times$ L) 3 mm $\times$ 25.8 mm
L10	stripline	$Z_0 = 50 \Omega$	[3] (W $\times$ L) 11 mm $\times$ 1.7 mm
L11	stripline	$Z_0 = 50 \Omega$	[3] (W $\times$ L) 9.5 mm $\times$ 1.7 mm
L12	stripline	$Z_0 = 34 \Omega$	[3] (W $\times$ L) 3 mm $\times$ 3 mm
L13	stripline	$Z_0 = 50 \Omega$	[3] (W $\times$ L) 12.7 mm $\times$ 1.7 mm
L14	stripline	$Z_0 = 43 \Omega$	[3] (W $\times$ L) 13.5 mm $\times$ 2.1 mm
R1	SMD resistor	4.7 $\Omega$ ; 0.1 W	

[1] American Technical Ceramics type 100A or capacitor of same quality.

[2] American Technical Ceramics type 100B or capacitor of same quality.

[3] Striplines are on a double copper-clad Taconic RF35 Printed-Circuit Board (PCB) ( $\epsilon_r = 3.5$ ); thickness = 0.76 mm.



**9. Package outline**

Flanged LDMOST ceramic package; 2 mounting holes; 2 leads

SOT502A

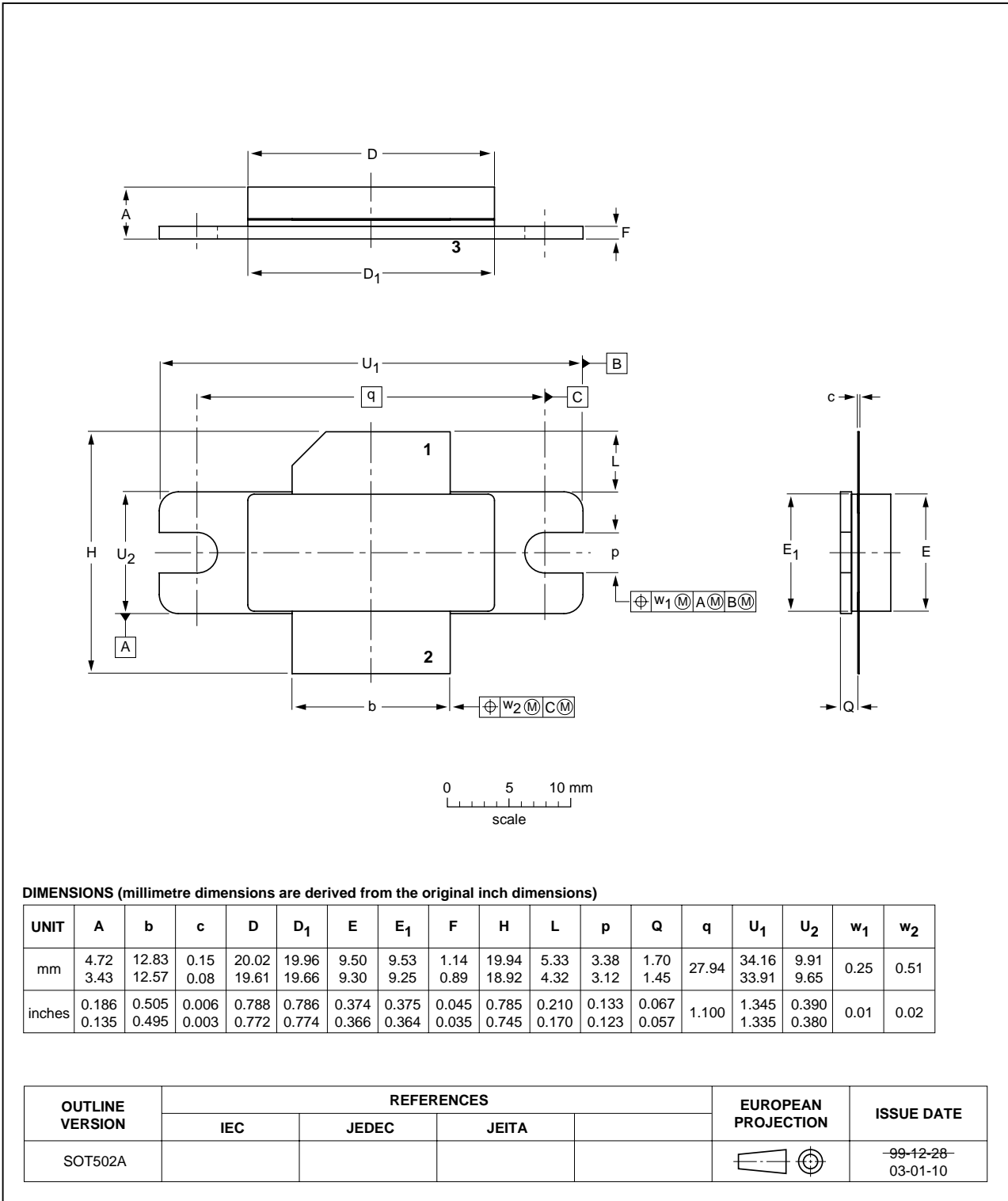

Fig 9. Package outline SOT502A

Earless flanged LDMOST ceramic package; 2 leads

SOT502B

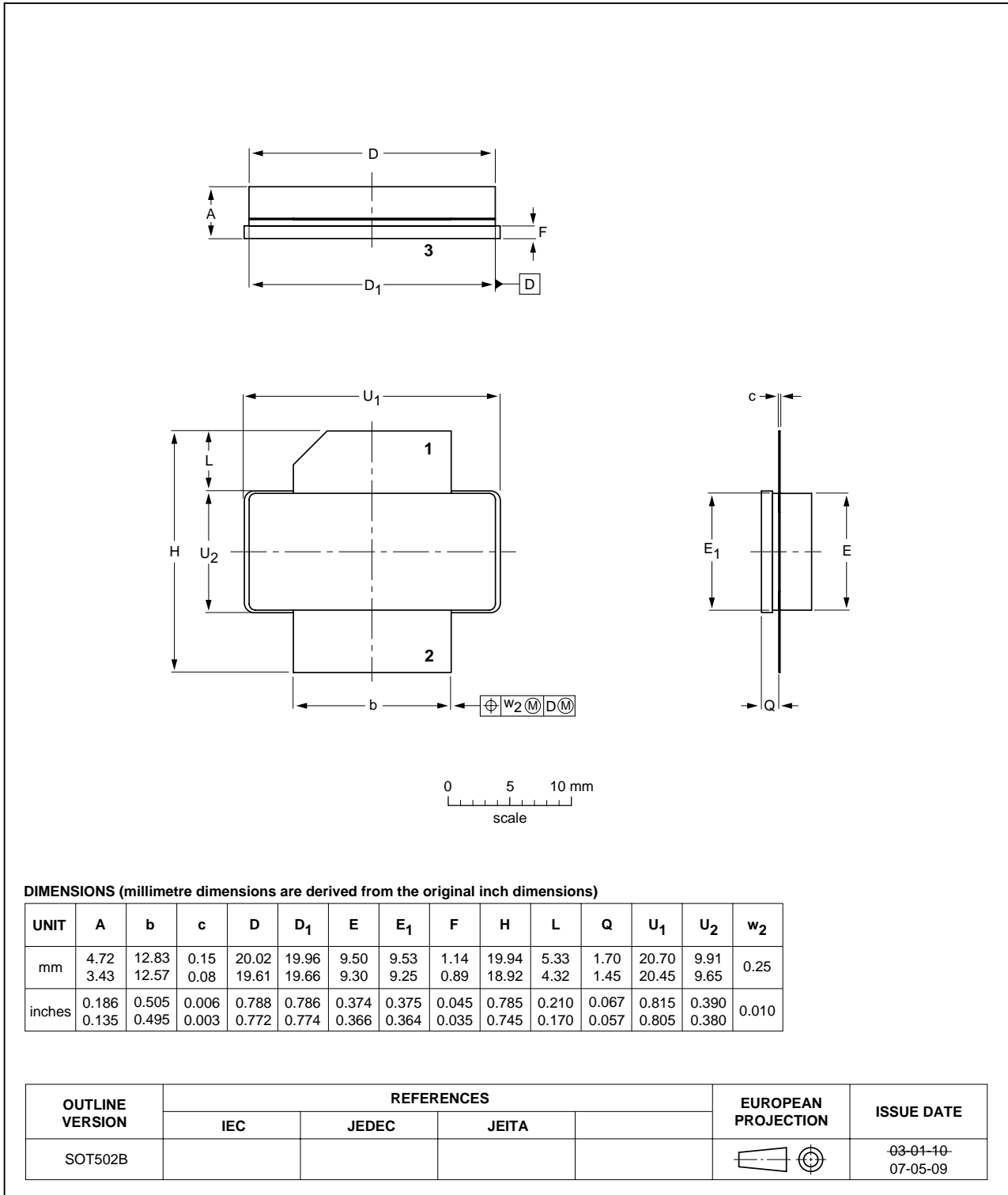

Fig 10. Package outline SOT502B

## 10. Abbreviations

**Table 10. Abbreviations**

Acronym	Description
3GPP	Third Generation Partnership Project
ACPR	Adjacent Channel Power Ratio
CCDF	Complementary Cumulative Distribution Function
CW	Continuous Wave
DPCH	Dedicated Physical CHannel
EDGE	Enhanced Data rates for GSM Evolution
EVM	Error Vector Magnitude
GSM	Global System for Mobile communications
LDMOS	Laterally Diffused Metal Oxide Semiconductor
LDMOST	Laterally Diffused Metal-Oxide Semiconductor Transistor
PAR	Peak-to-Average power Ratio
RF	Radio Frequency
VSWR	Voltage Standing Wave Ratio
W-CDMA	Wideband Code Division Multiple Access

## 11. Revision history

**Table 11. Revision history**

Document ID	Release date	Data sheet status	Change notice	Supersedes
BLF4G22-130_4G22LS-130_1	20070703	Product data sheet	-	-

## 12. Legal information

### 12.1 Data sheet status

Document status <sup>[1][2]</sup>	Product status <sup>[3]</sup>	Definition
Objective [short] data sheet	Development	This document contains data from the objective specification for product development.
Preliminary [short] data sheet	Qualification	This document contains data from the preliminary specification.
Product [short] data sheet	Production	This document contains the product specification.

[1] Please consult the most recently issued document before initiating or completing a design.

[2] The term 'short data sheet' is explained in section "Definitions".

[3] The product status of device(s) described in this document may have changed since this document was published and may differ in case of multiple devices. The latest product status information is available on the Internet at URL <http://www.nxp.com>.

### 12.2 Definitions

**Draft** — The document is a draft version only. The content is still under internal review and subject to formal approval, which may result in modifications or additions. NXP Semiconductors does not give any representations or warranties as to the accuracy or completeness of information included herein and shall have no liability for the consequences of use of such information.

**Short data sheet** — A short data sheet is an extract from a full data sheet with the same product type number(s) and title. A short data sheet is intended for quick reference only and should not be relied upon to contain detailed and full information. For detailed and full information see the relevant full data sheet, which is available on request via the local NXP Semiconductors sales office. In case of any inconsistency or conflict with the short data sheet, the full data sheet shall prevail.

### 12.3 Disclaimers

**General** — Information in this document is believed to be accurate and reliable. However, NXP Semiconductors does not give any representations or warranties, expressed or implied, as to the accuracy or completeness of such information and shall have no liability for the consequences of use of such information.

**Right to make changes** — NXP Semiconductors reserves the right to make changes to information published in this document, including without limitation specifications and product descriptions, at any time and without notice. This document supersedes and replaces all information supplied prior to the publication hereof.

**Suitability for use** — NXP Semiconductors products are not designed, authorized or warranted to be suitable for use in medical, military, aircraft, space or life support equipment, nor in applications where failure or

malfunction of a NXP Semiconductors product can reasonably be expected to result in personal injury, death or severe property or environmental damage. NXP Semiconductors accepts no liability for inclusion and/or use of NXP Semiconductors products in such equipment or applications and therefore such inclusion and/or use is at the customer's own risk.

**Applications** — Applications that are described herein for any of these products are for illustrative purposes only. NXP Semiconductors makes no representation or warranty that such applications will be suitable for the specified use without further testing or modification.

**Limiting values** — Stress above one or more limiting values (as defined in the Absolute Maximum Ratings System of IEC 60134) may cause permanent damage to the device. Limiting values are stress ratings only and operation of the device at these or any other conditions above those given in the Characteristics sections of this document is not implied. Exposure to limiting values for extended periods may affect device reliability.

**Terms and conditions of sale** — NXP Semiconductors products are sold subject to the general terms and conditions of commercial sale, as published at <http://www.nxp.com/profile/terms>, including those pertaining to warranty, intellectual property rights infringement and limitation of liability, unless explicitly otherwise agreed to in writing by NXP Semiconductors. In case of any inconsistency or conflict between information in this document and such terms and conditions, the latter will prevail.

**No offer to sell or license** — Nothing in this document may be interpreted or construed as an offer to sell products that is open for acceptance or the grant, conveyance or implication of any license under any copyrights, patents or other industrial or intellectual property rights.

### 12.4 Trademarks

Notice: All referenced brands, product names, service names and trademarks are the property of their respective owners.

## 13. Contact information

For additional information, please visit: <http://www.nxp.com>

For sales office addresses, send an email to: [salesaddresses@nxp.com](mailto:salesaddresses@nxp.com)

## 14. Contents

<b>1</b>	<b>Product profile</b> .....	<b>1</b>
1.1	General description .....	1
1.2	Features .....	1
1.3	Applications .....	2
<b>2</b>	<b>Pinning information</b> .....	<b>2</b>
<b>3</b>	<b>Ordering information</b> .....	<b>2</b>
<b>4</b>	<b>Limiting values</b> .....	<b>2</b>
<b>5</b>	<b>Thermal characteristics</b> .....	<b>3</b>
<b>6</b>	<b>Characteristics</b> .....	<b>3</b>
<b>7</b>	<b>Application information</b> .....	<b>3</b>
7.1	Ruggedness in class-AB operation .....	3
<b>8</b>	<b>Test information</b> .....	<b>6</b>
<b>9</b>	<b>Package outline</b> .....	<b>9</b>
<b>10</b>	<b>Abbreviations</b> .....	<b>11</b>
<b>11</b>	<b>Revision history</b> .....	<b>11</b>
<b>12</b>	<b>Legal information</b> .....	<b>12</b>
12.1	Data sheet status .....	12
12.2	Definitions .....	12
12.3	Disclaimers .....	12
12.4	Trademarks .....	12
<b>13</b>	<b>Contact information</b> .....	<b>12</b>
<b>14</b>	<b>Contents</b> .....	<b>13</b>

Please be aware that important notices concerning this document and the product(s) described herein, have been included in section 'Legal information'.



© NXP B.V. 2007.

All rights reserved.

For more information, please visit: <http://www.nxp.com>

For sales office addresses, please send an email to: [salesaddresses@nxp.com](mailto:salesaddresses@nxp.com)

Date of release: 3 July 2007

Document identifier: BLF4G22-130\_4G22LS-130\_1