

Features

- Schottky Barrier Chip
- Guard Ring Die Construction for Transient Protection
- Ideally Suited for Automatic Assembly
- Low Power Loss, High Efficiency
- Surge Overload Rating to 50A Peak
- For Use in Low Voltage, High Frequency Inverters, Free Wheeling, and Polarity Protection Application
- High Temperature Soldering: 260°C/10 Second at Terminal
- Available in Lead Free Finish/RoHS Compliant Version (Note 3)

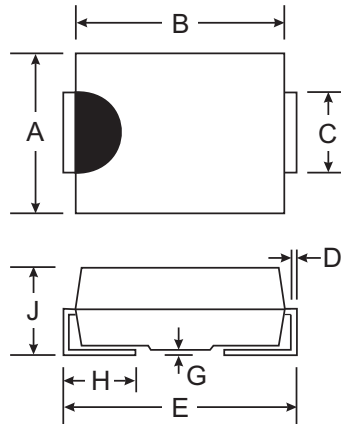

SMB		
Dim	Min	Max
A	3.30	3.94
B	4.06	4.57
C	1.96	2.21
D	0.15	0.31
E	5.00	5.59
G	0.10	0.20
H	0.76	1.52
J	2.00	2.62
All Dimensions in mm		

Mechanical Data

- Case: SMB
- Case Material: Molded Plastic. UL Flammability Classification Rating 94V-0
- Moisture Sensitivity: Level 1 per J-STD-020C
- Terminals: Solder Plated Terminal - Solderable per MIL-STD-202, Method 208
- Also Available in Lead Free Plating (Matte Tin Finish). Please See Ordering Information, Note 5, on Page 2
- Polarity: Cathode Band or Cathode Notch
- Marking: Type Number
- Weight: 0.093 grams (approximate)

Maximum Ratings and Electrical Characteristics @ T_A = 25°C unless otherwise specified

Single phase, half wave, 60Hz, resistive or inductive load.
For capacitive load, derate current by 20%.

Characteristic	Symbol	B270	B280	B290	B2100	Unit
Peak Repetitive Reverse Voltage	V _{RRM}	70	80	90	100	V
Working Peak Reverse Voltage	V _{RWM}					
DC Blocking Voltage	V _R					
RMS Reverse Voltage	V _{R(RMS)}	49	56	63	70	V
Average Rectified Output Current @ T _T = 125°C	I _O	2.0				A
Non-Repetitive Peak Forward Surge Current 8.3ms single half sine-wave superimposed on rated load (JEDEC Method)	I _{FSM}	50				A
Forward Voltage @ I _F = 2.0A @ T _A = 25°C @ T _A = 100°C	V _{FM}	0.79 0.69				V
Peak Reverse Current at Rated DC Blocking Voltage @ T _A = 25°C @ T _A = 100°C	I _{RM}	0.5 15				mA
Typical Total Capacitance (Note 2)	C _T	75				pF
Typical Thermal Resistance Junction to Terminal (Note 1)	R _{θJT}	15				°C/W
Operating and Storage Temperature Range	T _j , T _{STG}	-65 to +150				°C

- Notes:
1. Valid provided that terminals are kept at ambient temperature.
 2. Measured at 1.0 MHz and Applied Reverse Voltage of 4.0V DC.
 3. RoHS revision 13.2.2003. Glass and High Temperature Solder Exemptions Applied, see EU Directive Annex Notes 5 and 7.

Ordering Information (Note 4 & 5)

Device*	Packaging	Shipping
B2xxx-13	SMB	3000/Tape & Reel

* x = Device type, e.g. B270-13

- Notes:
4. For Packaging Details, go to our website at <http://www.diodes.com/datasheets/ap02007.pdf>.
 5. For Lead Free Finish/RoHS Compliant version part number, please add "-F" suffix to the part number above. Example: B270-13-F.

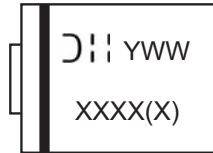

XXXX = Product type marking code, ex: B290 (SMB package)
D||| = Manufacturers' code marking
YWW = Date code marking
Y = Last digit of year ex: 2 for 2002
WW = Week code 01 to 52

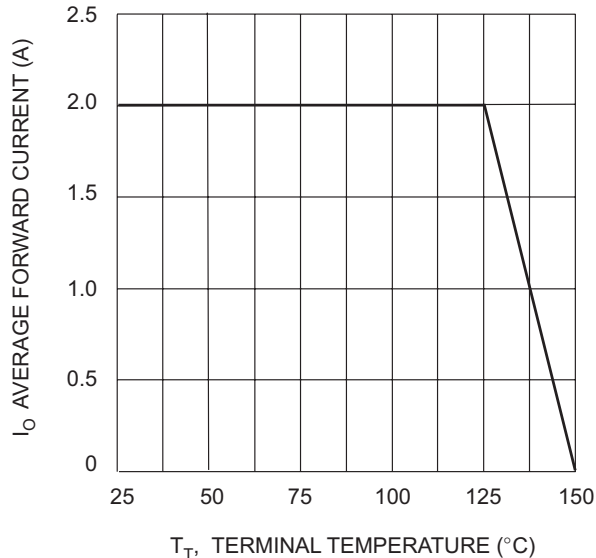

Fig. 1 Forward Current Derating Curve

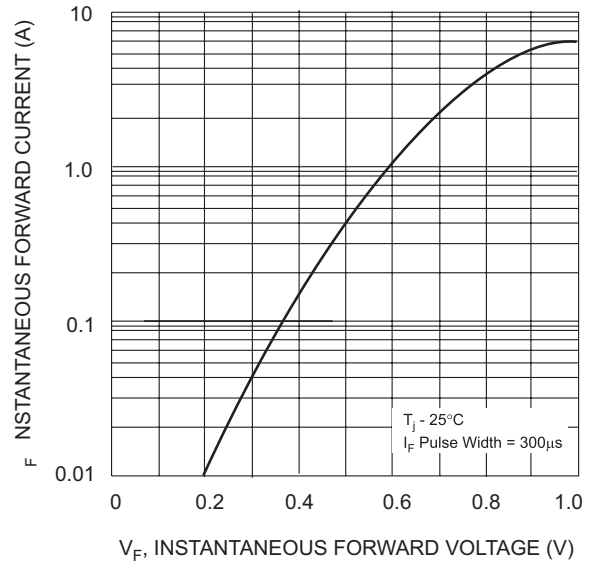

Fig. 2 Typical Forward Characteristics

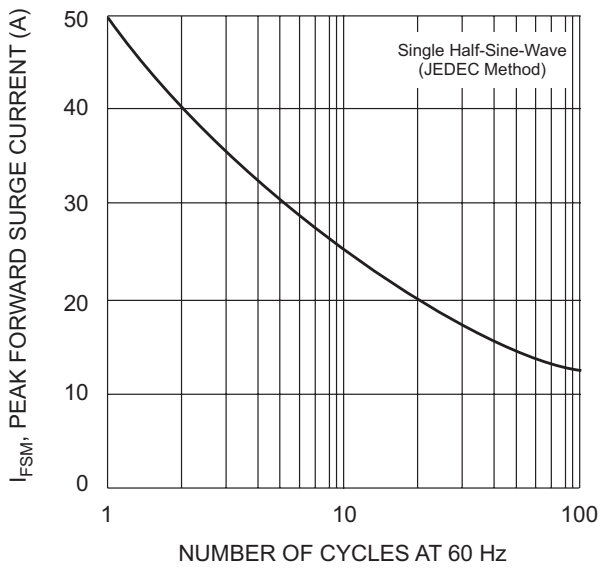

Fig. 3 Max Non-Repetitive Peak Forward Surge Current

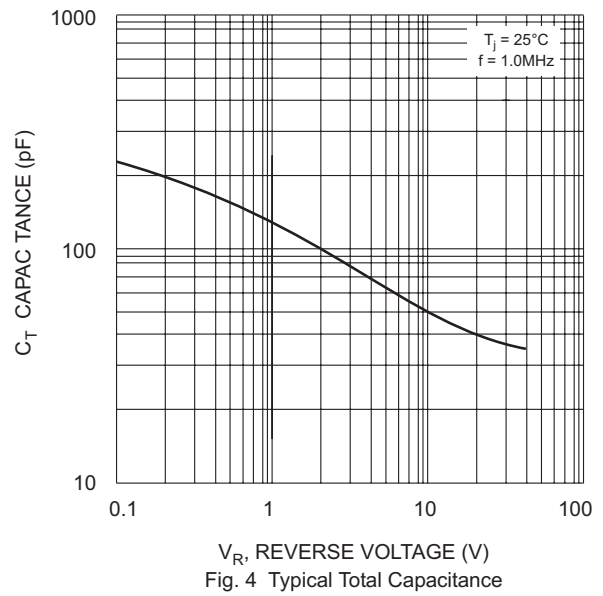

Fig. 4 Typical Total Capacitance

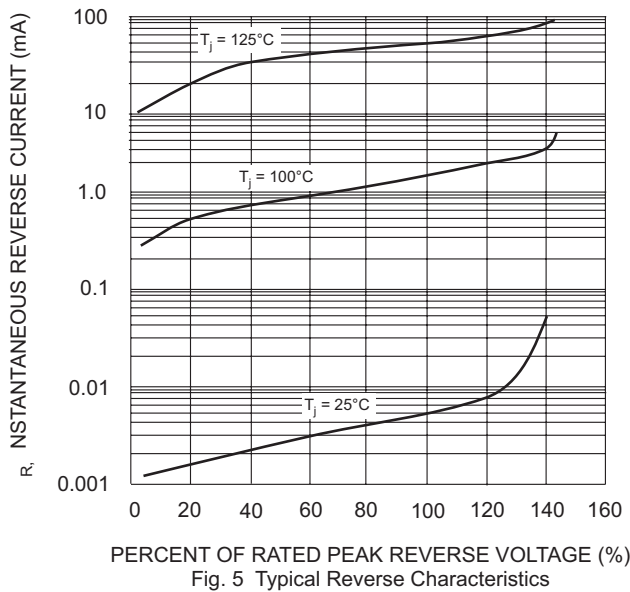

Fig. 5 Typical Reverse Characteristics