

LPC-H1114 development board

Users Manual



All boards produced by Olimex are ROHS compliant

Revision B, June 2012

Copyright(c) 2011, OLIMEX Ltd, All rights reserved

INTRODUCTION

LPC-P1114 is development board with LPC1114FBD48 ARM Cortex-M0 based microcontroller for embedded applications from NXP. LPC-P1114 featuring a high level of integration and low power consumption. This microcontroller supports various interfaces such as one Fast-mode Plus I2C-bus interface, one RS-485/EIA-485 UART, two SSP interfaces, four general purpose timers, a 10-bit ADC. On the board are available Debug Interface and extension headers for all microcontroller ports.

BOARD FEATURES

- MCU: **LPC1114FBD48/301/302** Cortex-M0, up to 50 Mhz, 32 kB Flash, 8kB SRAM, UART RS-485, two SSP, I²C/Fast+, ADC
- Debug interface – SWD (Serial Wire Debug)
- Extension connectors
- FR-4, 1.5 mm, soldermask, component print
- Dimensions:38.00x38.00mm (1.50 x 1.50")

ELECTROSTATIC WARNING

The **LPC-H1114** board is shipped in protective anti-static packaging. The board must not be subject to high electrostatic potentials. General practice for working with static sensitive devices should be applied when working with this board.

BOARD USE REQUIREMENTS

Cables: The cable you will need depends on the programmer/debugger you use. If you use [ARM-JTAG-EW](#), you will need USB A-B cable.

Hardware: Programmer/Debugger [ARM-JTAG-EW](#), which works with IAR for ARM up to version 6.20 or other compatible programming/debugging tool.

[ARM-USB-OCD](#), [ARM-USB-OCD-H](#), [ARM-USB-TINY](#), [ARM-USB-TINY-H](#) - JTAGs + [ARM-JTAG-SWD](#) adapter can be used with Rowley Crossworks.

PROCESSOR FEATURES

LPC-P1114 board use ARM Cortex™-M0 microcontroller **LPC1114FBD48/301/302** from NXP Semiconductors with these features:

- ARM Cortex-M0 processor, running at frequencies of up to 50 MHz.
- ARM Cortex-M0 built-in Nested Vectored Interrupt Controller (NVIC).
- 32 kB on-chip flash programming memory.
- 8 kB SRAM.

- In-System Programming (ISP) and In-Application Programming (IAP) via on-chip bootloader software.
- Serial interfaces:
 - UART with fractional baud rate generation, internal FIFO, and RS-485 support.
 - Two SSP controllers with FIFO and multi-protocol capabilities
 - I²C-bus interface supporting full I²C-bus specification and Fast-mode Plus with a data rate of 1 Mbit/s with multiple address recognition and monitor mode.
- Other peripherals:
 - 42 General Purpose I/O (GPIO) pins with configurable pull-up/pull-down resistors. In addition, a configurable open-drain mode is supported on the LPC1114FBD48/302
 - Four general purpose timers/counters with a total of four capture inputs and 13 match outputs.
 - Programmable WatchDog Timer (WDT).
 - Programmable windowed WDT on LPC1114FBD48/302 only.
 - System tick timer.
- Serial Wire Debug.
- High-current output driver (20 mA) on one pin.
- High-current sink drivers (20 mA) on two I²C-bus pins in Fast-mode Plus.
- Integrated PMU (Power Management Unit) to minimize power consumption during Sleep, Deep-sleep, and Deep power-down modes.
- Power profiles residing in boot ROM allowing to optimize performance and minimize power consumption for any given application through one simple function call. (on LPC1114FBD48/302 only.)
- Three reduced power modes: Sleep, Deep-sleep, and Deep power-down.
- Single 3.3 V power supply (2.0 V to 3.6 V).
- 10-bit ADC with input multiplexing among 8 pins.
- GPIO pins can be used as edge and level sensitive interrupt sources.
- Clock output function with divider that can reflect the system oscillator clock, IRC clock, CPU clock, and the Watchdog clock
- Processor wake-up from Deep-sleep mode via a dedicated start logic using up to 13 of the functional pins.
- Brownout detect with four separate thresholds for interrupt and one threshold for forced reset.
- Power-On Reset (POR).

-Crystal oscillator with an operating range of 1 MHz to 25 MHz.

-12 MHz internal RC oscillator trimmed to 1 % accuracy that can optionally be used as a system clock.

-PLL allows CPU operation up to the maximum CPU rate without the need for a high-frequency crystal. May be run from the main oscillator, the internal RC oscillator, or the watchdog oscillator.

BLOCK DIAGRAM

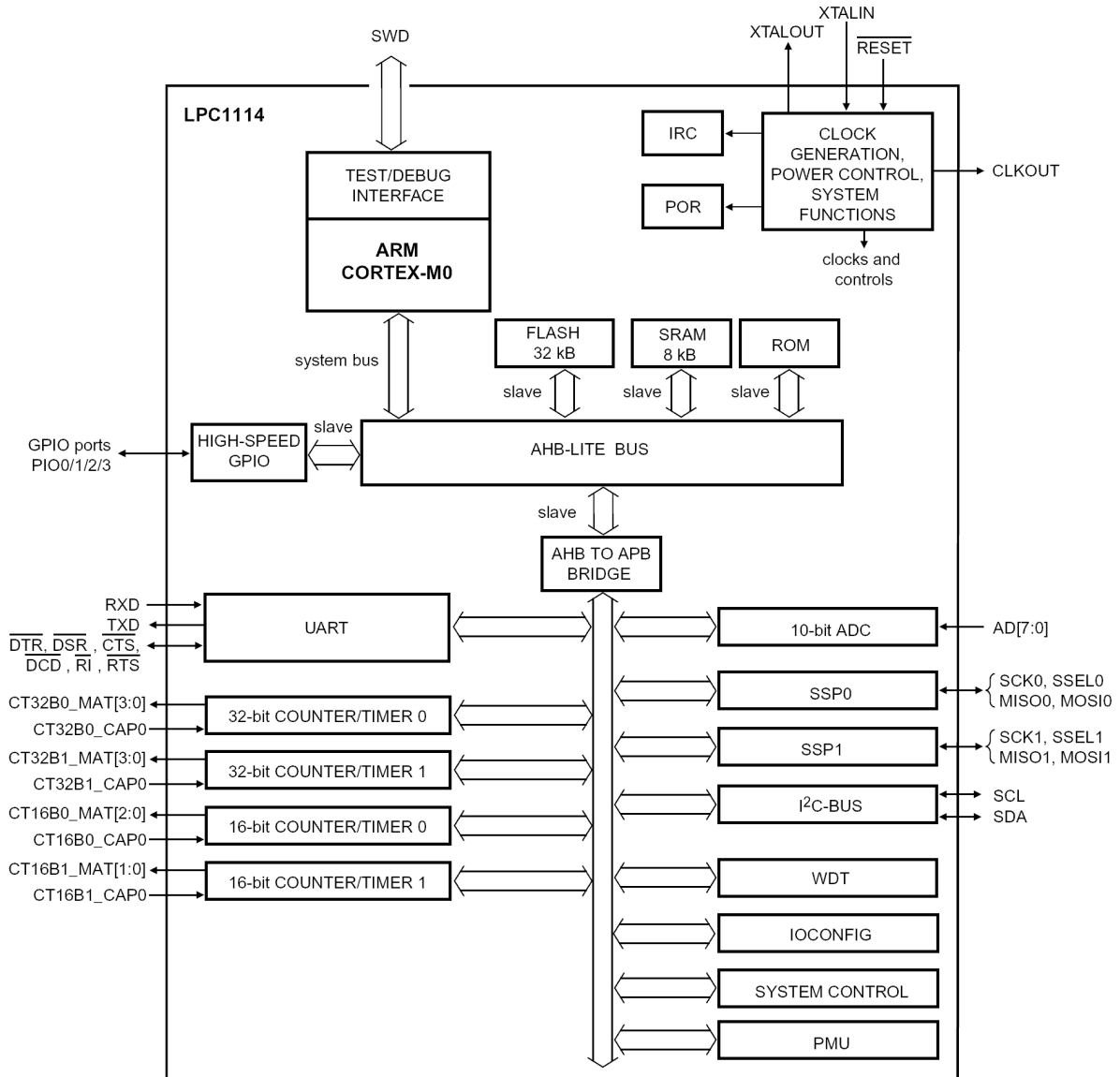

BOARD LAYOUT

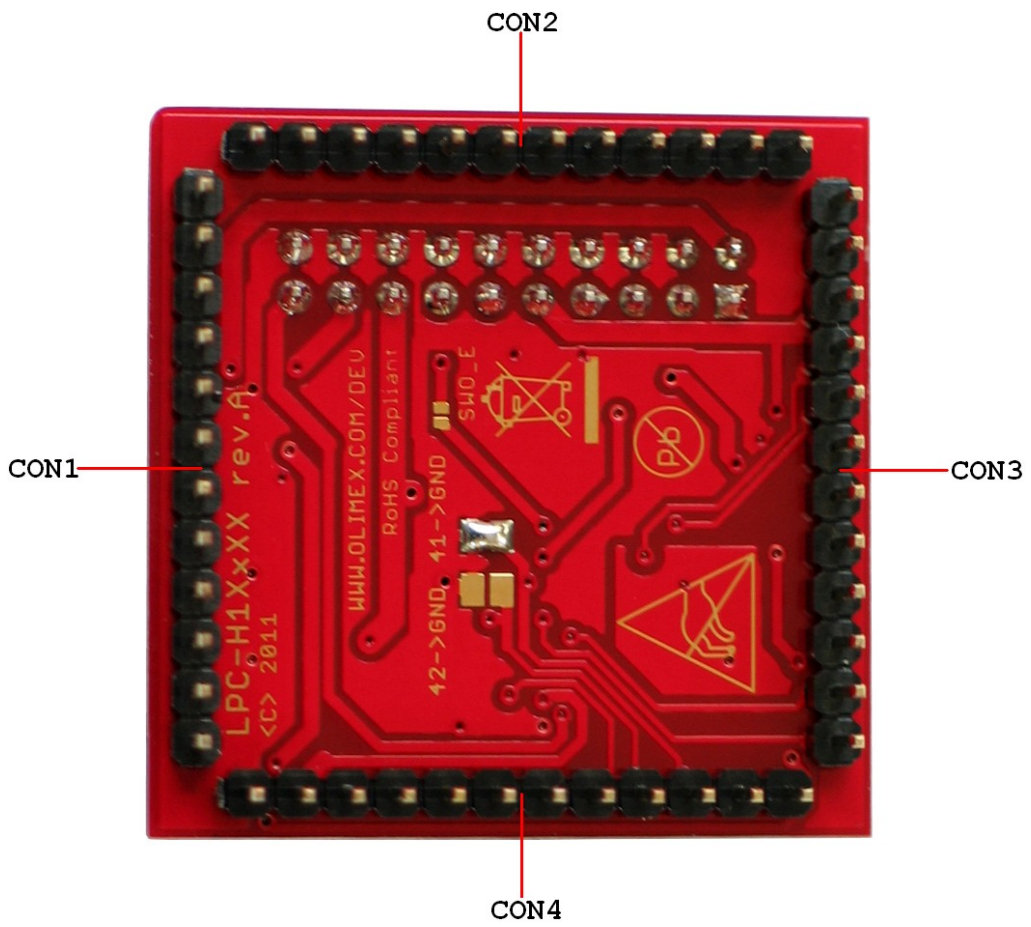
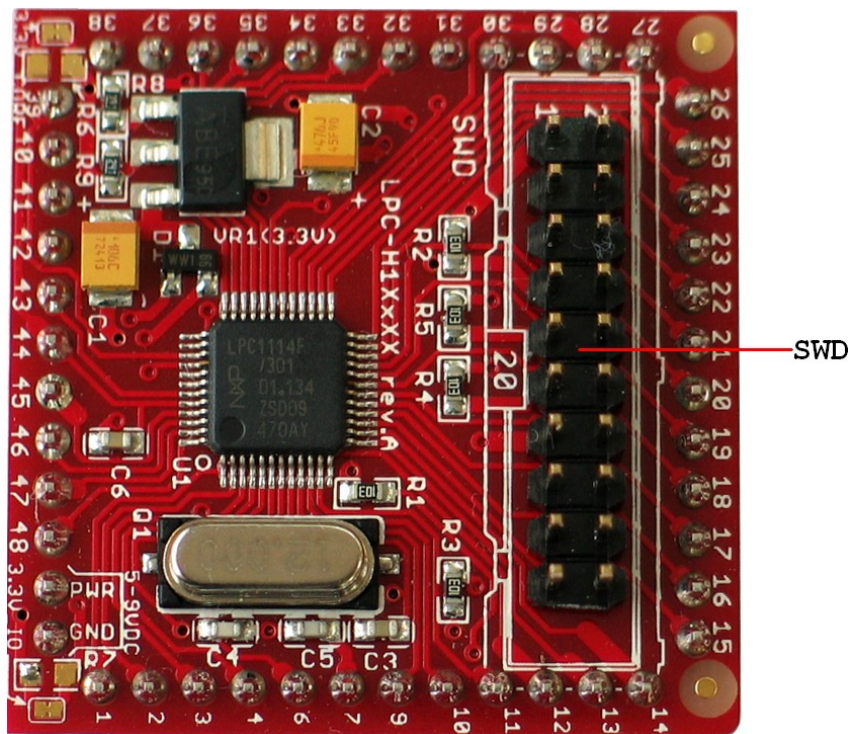

POWER SUPPLY CIRCUIT

LPC-H1114 is power supplied with +5V via JTAG and (5÷9)VDC via Extension connector CON4 pins PWR and GND.

The board power consumption is about 20 mA.

RESET CIRCUIT

LPC-P1114 reset circuit includes LPC1114 pin 3 (#RESET/PIO0_0), R1 (10k) and SWD connector pin 15.

CLOCK CIRCUIT

Quartz crystal 12 MHz is connected to LPC1114 pin 6 (XTALIN) and pin 7 (XTALOUT).

JUMPER DESCRIPTION

3.3V_CORE



This jumper, when closed, enables microcontroller 3.3V power supply.
Default state is closed.

3.3V_IO



This jumper, when closed, supplies 3.3 V voltage to LPC1114 pin 8 (VDDIO).
Default state is closed.

SWO_E



This jumper, when closed, connects SWD connector pin 13 (SWO_SWD) to LPC1114 pin 28 (PIO0_9).
Default state is opened.

41->GND



This jumper, when closed, connects LPC1114 pin 41 (VSS) to GND.
Default state is closed.

42->GND



This jumper, when closed, connects LPC1114 pin 42 (PIO1_11) to GND.
Default state is opened.

EXTERNAL CONNECTORS DESCRIPTION

SWD

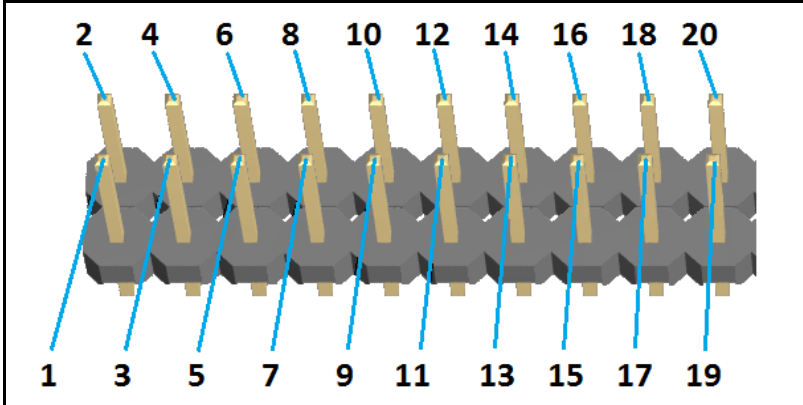

Pin #	Signal Name	Pin #	Signal Name
1	VCC (3.3V)	2	VCC (3.3V)
3	Not Connected	4	GND
5	Not Connected	6	GND
7	SWDIO	8	GND
9	SWCLK	10	GND
11	pull-down	12	GND
13	SWO_SWD	14	GND
15	RSTN	16	GND
17	pull-down	18	GND
19	+5V_JTAG	20	GND

CON1

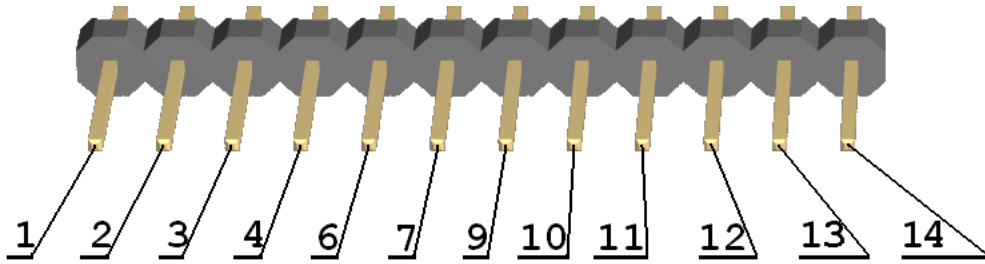

Pin #	Signal Name	Pin #	Signal Name
1	PIO2_6	2	PIO2_0
3	RSTN	4	PIO0_1
6	XTALIN	7	XTALOUT
9	PIO1_8	10	PIO0_2
11	PIO2_7	12	PIO2_8
13	PIO2_1	14	PIO0_3

CON2

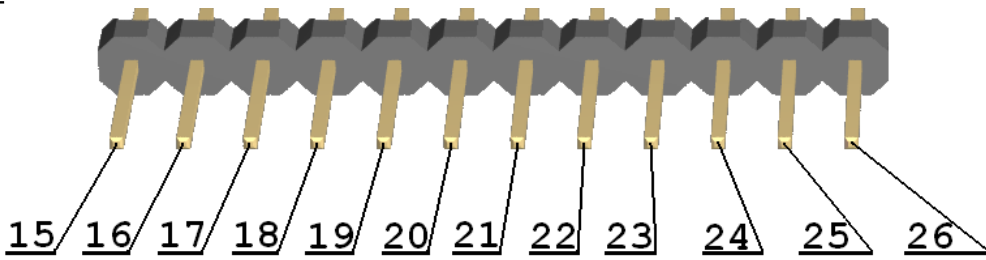

Pin #	Signal Name	Pin #	Signal Name
15	PIO0_4	16	PIO0_5
17	PIO1_9	18	PIO3_4
19	PIO2_4	20	PIO2_5
21	PIO3_5	22	PIO0_6
23	PIO0_7	24	PIO2_9
25	PIO2_10	26	PIO2_2

CON3

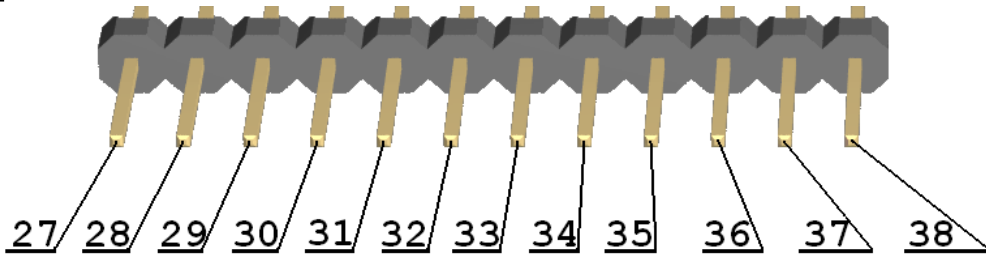

Pin #	Signal Name	Pin #	Signal Name
27	PIO0_8	28	SWO
29	SWCLK	30	PIO1_10
31	PIO2_11	32	PIO0_11
33	PIO1_0	34	PIO1_1
35	PIO1_2	36	PIO3_0
37	PIO3_1	38	PIO2_3

CON4

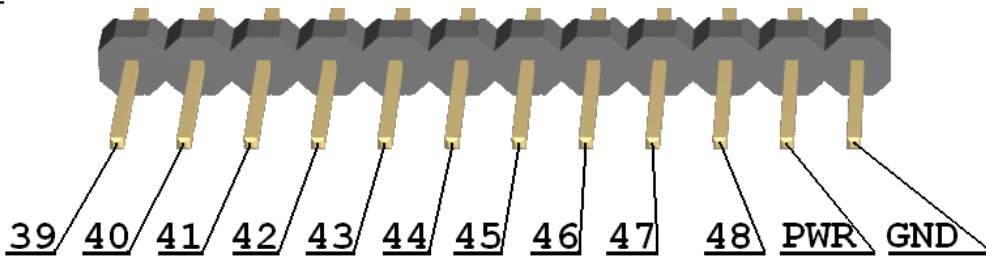

Pin #	Signal Name	Pin #	Signal Name
39	SWDIO	40	PIO1_4
41	VSS (GND)	42	PIO1_11
43	PIO3_2	44	VDD(3V3)
45	PIO1_5	46	PIO1_6
47	PIO1_7	48	PIO3_3
PWR	PWR	GND	GND

MECHANICAL DIMENSIONS

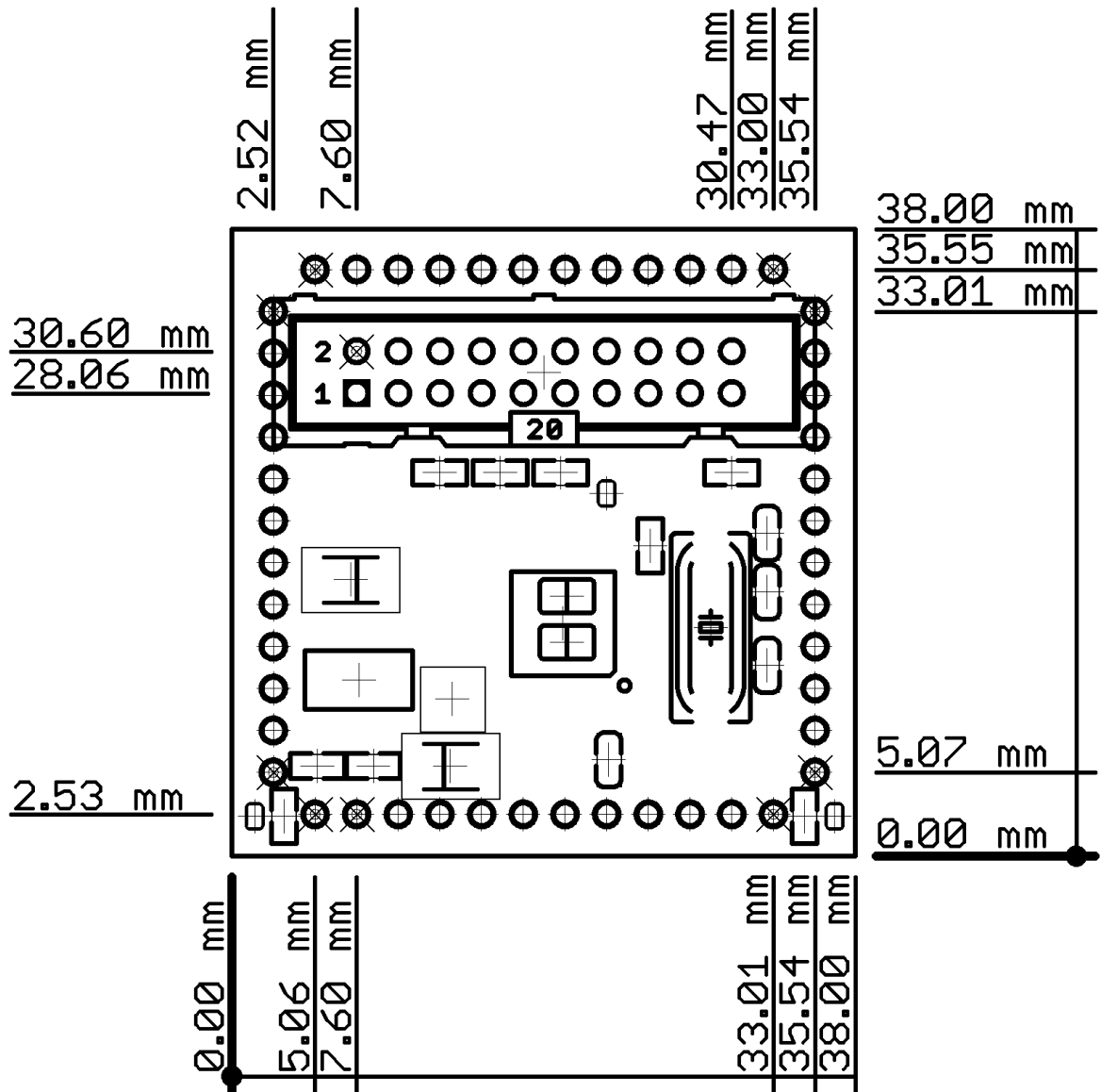

AVAILABLE DEMO SOFTWARE

- Coming soon at our [website](#).

ORDER CODE

LPC-H1114 - assembled and tested board

How to order?

You can order to us directly or by any of our distributors.
Check our web www.olimex.com/dev for more info.

Revision history

Board's Revision	Rev. A, July 2011
Manual's Revision	Rev. Initial, September 2011
	Rev. B, June 2012 – changed wrong pin numbering of the picture on page 9

Disclaimer

© 2011 Olimex Ltd. All rights reserved. Olimex®, logo and combinations thereof, are registered trademarks of Olimex Ltd. Other terms and product names may be trademarks of others.

The information in this document is provided in connection with Olimex products. No license, express or implied or otherwise, to any intellectual property right is granted by this document or in connection with the sale of Olimex products.

Neither the whole nor any part of the information contained in or the product described in this document may be adapted or reproduced in any material from except with the prior written permission of the copyright holder.

The product described in this document is subject to continuous development and improvements. All particulars of the product and its use contained in this document are given by OLIMEX in good faith. However all warranties implied or expressed including but not limited to implied warranties of merchantability or fitness for purpose are excluded.

This document is intended only to assist the reader in the use of the product. OLIMEX Ltd. shall not be liable for any loss or damage arising from the use of any information in this document or any error or omission in such information or any incorrect use of the product.