



GRL18SG-F2339

GR18S

CYLINDRICAL PHOTOELECTRIC SENSORS

SICK
Sensor Intelligence.



Ordering information

| Type | Part no. |
|---------------|----------|
| GRL18SG-F2339 | 1059554 |

Other models and accessories → www.sick.com/GR18S

Illustration may differ



Detailed technical data

Features

| | |
|--|--|
| Sensor/ detection principle | Photoelectric retro-reflective sensor, Dual lens |
| Housing design (light emission) | Cylindrical |
| Thread diameter (housing) | M18 x 1 |
| Optical axis | Radial |
| Sensing range max. | 0.03 m ... 7.2 m ¹⁾ |
| Sensing range | 0.06 m ... 6 m ¹⁾ |
| Type of light | Visible red light |
| Light source | PinPoint LED ²⁾ |
| Light spot size (distance) | Ø 175 mm (7 m) |
| Wave length | 650 nm |
| Adjustment | Potentiometer, 270° |
| Special applications | Detecting transparent objects |

¹⁾ Reflector PL80A.

²⁾ Average service life: 100,000 h at T_U = +25 °C.

Mechanics/electronics

| | |
|-----------------------|-----------------------------------|
| Supply voltage | 10 V DC ... 30 V DC ¹⁾ |
| Ripple | ± 5 V _{pp} ²⁾ |

¹⁾ Limit values when operated in short-circuit protected network: max. 8 A.

²⁾ May not exceed or fall below U_v tolerances.

³⁾ At U_v > 24 V or ambient temperature > 49 °C, I_A max. = 50 mA.

⁴⁾ Signal transit time with resistive load.

⁵⁾ With light/dark ratio 1:1.

⁶⁾ A = V_S connections reverse-polarity protected.

⁷⁾ B = inputs and output reverse-polarity protected.

⁸⁾ D = outputs overcurrent and short-circuit protected.

⁹⁾ At U_v ≤ 24V and I_A < 50mA.

¹⁰⁾ Temperature stability following adjustment +/-10 °C.

| | |
|---|---|
| Power consumption | 30 mA |
| Switching output | PNP |
| Switching mode | Dark switching |
| Signal voltage PNP HIGH/LOW | $V_S - (\leq 3 \text{ V}) / \text{ approx. } 0 \text{ V}$ |
| Output current I_{max} | 100 mA ³⁾ |
| Response time | < 500 μs ⁴⁾ |
| Switching frequency | 1,000 Hz ⁵⁾ |
| Connection type | Connector M12, 3-pin |
| Circuit protection | A ⁶⁾ B ⁷⁾ D ⁸⁾ |
| Protection class | III |
| Polarisation filter | ✓ |
| Housing material | Plastic, ABS |
| Optics material | Plastic, PMMA |
| Enclosure rating | IP67 |
| Items supplied | Fastening nuts (2 x) |
| Special feature | Detecting transparent objects |
| EMC | EN 60947-5-2 |
| Ambient operating temperature | -25 °C ... +55 °C ^{10) 9)} |
| Ambient storage temperature | -40 °C ... +70 °C |
| UL File No. | NRKH.E348498 & NRKH7.E348498 |

¹⁾ Limit values when operated in short-circuit protected network: max. 8 A.

²⁾ May not exceed or fall below U_V tolerances.

³⁾ At $U_V > 24 \text{ V}$ or ambient temperature > 49 °C, $I_A \text{ max.} = 50 \text{ mA}$.

⁴⁾ Signal transit time with resistive load.

⁵⁾ With light/dark ratio 1:1.

⁶⁾ A = V_S connections reverse-polarity protected.

⁷⁾ B = inputs and output reverse-polarity protected.

⁸⁾ D = outputs overcurrent and short-circuit protected.

⁹⁾ At $U_V \leq 24 \text{ V}$ and $I_A < 50 \text{ mA}$.

¹⁰⁾ Temperature stability following adjustment +/-10 °C.

Classifications

| | |
|---------------------|----------|
| ECl@ss 5.0 | 27270902 |
| ECl@ss 5.1.4 | 27270902 |
| ECl@ss 6.0 | 27270902 |
| ECl@ss 6.2 | 27270902 |
| ECl@ss 7.0 | 27270902 |
| ECl@ss 8.0 | 27270902 |
| ECl@ss 8.1 | 27270902 |
| ECl@ss 9.0 | 27270902 |
| ETIM 5.0 | EC002717 |
| ETIM 6.0 | EC002717 |

UNSPSC 16.0901

39121528

Connection diagram

Cd-045

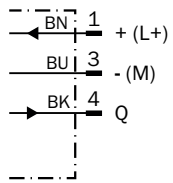

Characteristic curve

GRL18S

Operating reserve

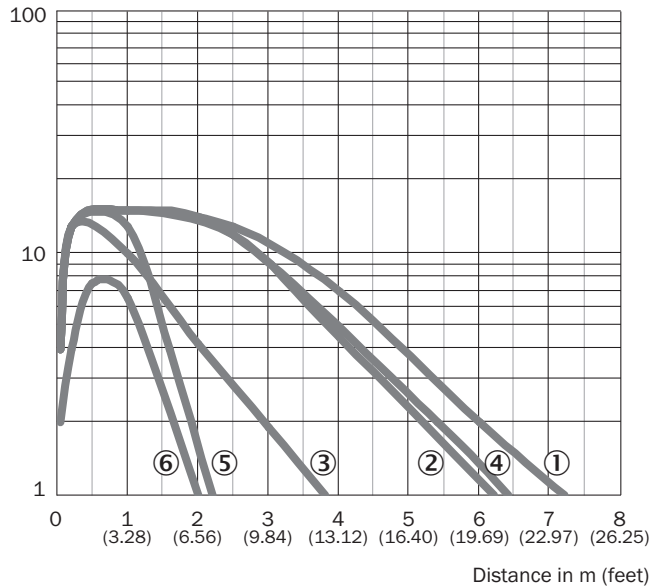

- ① Reflector PL80A
- ② Reflector PL40A
- ③ Reflector PL20A
- ④ Reflector P250
- ⑤ Reflector PL22
- ⑥ Reflective tape REF-Plus 3436

Light spot size

GRL18S

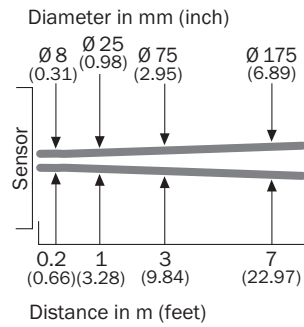

Sensing range diagram

GRL18S

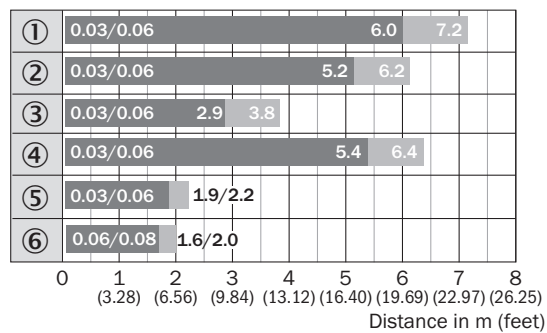

■ Sensing range ■ Sensing range max.

- ① Reflector PL80A
- ② Reflector PL40A
- ③ Reflector PL20A
- ④ Reflector P250
- ⑤ Reflector PL22
- ⑥ Reflective tape REF-Plus 3436

Dimensional drawing (Dimensions in mm (inch))

GR18S, plastic, connector, angled

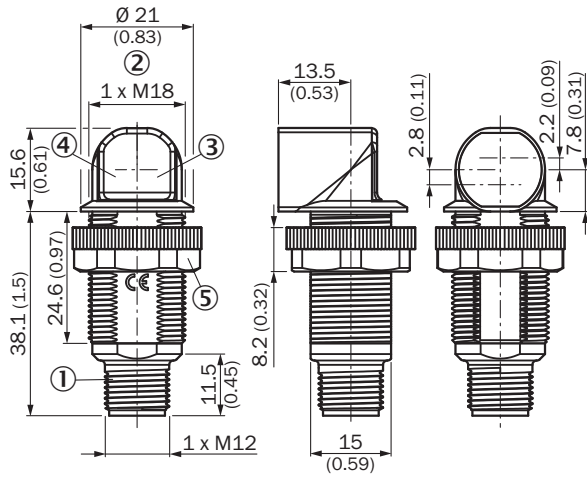





- ① Connector M12, 3-pin
- ② Threaded mounting hole M18 x 1
- ③ LED indicator yellow
- ④ LED indicator green
- ⑤ Fastening nut; 22 mm hex, plastic

Recommended accessories

Other models and accessories → www.sick.com/GR18S

| | Brief description | Type | Part no. |
|-------------------|---|---------------|----------|
| Reflectors | | | |
| | Rectangular, screw connection, 80 mm x 80 mm, PMMA/ABS, Screw-on, 2 hole mounting | PL80A | 1003865 |
| | Fine triple reflector, screw connection, suitable for laser sensors, 47 mm x 47 mm, PMMA/ABS, Screw-on, 2 hole mounting | P250F | 5308843 |
| | Fine triple reflector, screw connection, suitable for laser sensors, 18 mm x 18 mm, PMMA/ABS, Screw-on, 2 hole mounting | PL10F | 5311210 |
| | Fine triple reflector, screw connection, suitable for laser sensors, 38 mm x 16 mm, PMMA/ABS, Screw-on, 2 hole mounting | PL20F | 5308844 |
| | Fine triple reflector, screw connection, suitable for laser sensors, 56 mm x 28 mm, PMMA/ABS, Screw-on, 2 hole mounting | PL30F | 5326523 |
| | Fine triple reflector, screw connection, suitable for laser sensors, 76 mm x 45 mm, PMMA/ABS, Screw-on, 2 hole mounting | PL81-1F | 5325060 |
| | Suitable for laser sensors, self-adhesive, cut, see alignment note, 56.3 mm x 56.3 mm, self-adhesive | REF-AC1000-56 | 4063030 |

| | Brief description | Type | Part no. |
|---|---|------------|----------|
|  | Fine triple reflector, chemically resistant, screw connection, 18 mm x 18 mm, Plastic, Screw-on, 2 hole mounting | PL10F CHEM | 5321636 |
|  | Chemically resistant, screw connection, suitable for laser sensors, 16 mm x 38 mm, Plastic, Screw-on, 2 hole mounting | PL20F-CHEM | 5326089 |
|  | Stainless steel reflector, hygienic design, chemically resistant, enclosure rating IP69K, D12 adapter shaft, PMMA front screens, 25 mm x 25 mm, Stainless steel V4A (1.4404, 316L), D12-adapter shaft | PLH25-D12 | 2063404 |
|  | Stainless steel reflector, hygienic design, chemically resistant, Enclosure rating IP 69K, M12-adapter thread, PMMA front screens, 25 mm x 25 mm, Stainless steel V4A (1.4404, 316L), M12-adapter thread | PLH25-M12 | 2063403 |
|  | Stainless steel reflector, washdown design, chemically resistant, IP 69K enclosure rating, screw connection, PMMA front screens, 14 mm x 14 mm, Stainless steel V4A (1.4404, 316L), Screw-on, 2 hole mounting | PLV14-A | 2063405 |

SICK AT A GLANCE

SICK is one of the leading manufacturers of intelligent sensors and sensor solutions for industrial applications. A unique range of products and services creates the perfect basis for controlling processes securely and efficiently, protecting individuals from accidents and preventing damage to the environment.

We have extensive experience in a wide range of industries and understand their processes and requirements. With intelligent sensors, we can deliver exactly what our customers need. In application centers in Europe, Asia and North America, system solutions are tested and optimized in accordance with customer specifications. All this makes us a reliable supplier and development partner.

Comprehensive services complete our offering: SICK LifeTime Services provide support throughout the machine life cycle and ensure safety and productivity.

For us, that is “Sensor Intelligence.”

WORLDWIDE PRESENCE:

Contacts and other locations –www.sick.com