

**Description**

- Standard 7 x 5mm crystal oscillator in a ceramic package with a seam sealed metal lid, hermetically sealed.
- Model CFPS-72
- Model Issue number 12

**Frequency Parameters**

- Frequency 50.0MHz
- Frequency Stability  $\pm 50.00\text{ppm}$
- Operating Temperature Range 0.00 to 70.00°C
- Ageing  $\pm 3\text{ppm per year max}$

**Electrical Parameters**

- Supply Voltage 5.0V  $\pm 10\%$
- Current Draw 50.00mA

**Output Details**

- Output Compatibility HCMOS/TTL
- Drive Capability 50pF max
- Rise and Fall Time 6.0ns max
- Duty Cycle 45/55%

**Output Control**

- Standby Operation:  
Logic '1' ( $>70\% V_s$ ) to pad 1 enables oscillator output.  
Logic '0' ( $<30\% V_s$ ) to pad 1 disables oscillator output; the oscillator output goes to the high impedance state.  
No connection to pad 1 enables oscillator output.
- Standby Current: 10 $\mu\text{A}$  max

**Noise Parameters**

- Phase Jitter RMS : 350fs typical

**Environmental Parameters**

- Shock: MIL-STD-202, Method 213, Condition E.
- Vibration: MIL-STD-883, Method 2007, Condition A.

**Compliance**

- RoHS Status (2011/65/EU) Compliant
- REACH Status Compliant
- MSL Rating (JDEC-STD-033): Not Applicable

**Packaging Details**

- Pack Style: Bulk Loose in bulk pack  
Pack Size: 100
- *Alternative packing option available*

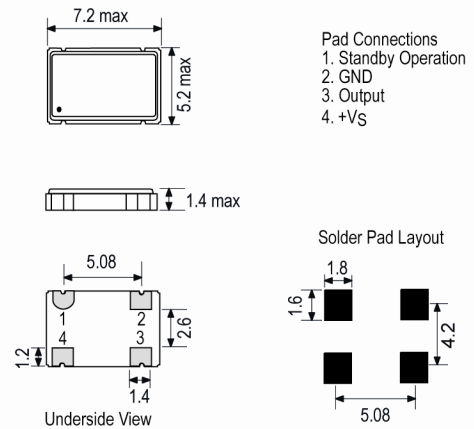
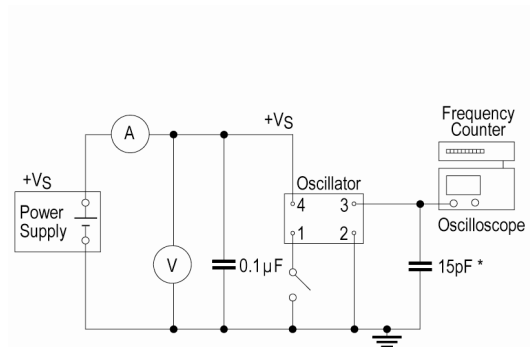
**Outline (mm)**

**Test Circuit**

\* Inclusive of jigging and equipment capacitance

**Sales Office Contact Details:**

UK: +44 (0)1460 270200  
Germany: 0800 1808 443

France: 0800 901 383  
USA: +1.760.318.2824

Email: [info@iqdfrequencyproducts.com](mailto:info@iqdfrequencyproducts.com)  
Web: [www.iqdfrequencyproducts.com](http://www.iqdfrequencyproducts.com)

**Wave Form**

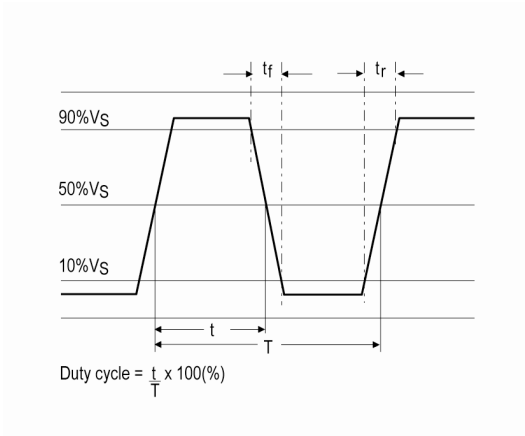

**Sales Office Contact Details:**

UK: +44 (0)1460 270200  
Germany: 0800 1808 443

France: 0800 901 383  
USA: +1.760.318.2824

Email: [info@iqdfrequencyproducts.com](mailto:info@iqdfrequencyproducts.com)  
Web: [www.iqdfrequencyproducts.com](http://www.iqdfrequencyproducts.com)