

Choice of PWM Controller

The ISL684x family of devices are superior performing pin compatible replacements for the industry standard 384x single-ended current mode PWM controllers. Also available in 8 Ld MSOP and 8 Ld SOIC, the ISL6841 in the space saving 2mmx3mm DFN package is used in the ISL6841EVAL3Z evaluation board.

The design requirements of this application require the superior performance characteristics of the ISL6841. Some key features of this part include:

- Tight internal voltage reference of 1%.
- 40ns peak current sensing.
- Internal 1A MOSFET driver.

The ISL6841 was selected for its UVLO threshold and its 50% maximum duty cycle limit. In addition, its low UVLO start threshold would help in easily modifying the design in catering to lower input voltage applications.

Topology Selection

This evaluation board was designed to allow for maximum flexibility, targeting applications that use a typical battery input of 24V. Given the low input voltages for this application, a single-ended topology would be ideal. The flyback topology was selected for the low power levels targeted by this application with emphasis on low BOM cost. Continuous conduction mode of operation was chosen to achieve higher efficiencies at the expense of lower bandwidth of operation, a direct consequence of transition from continuous to discontinuous mode of operation.

For feature-rich applications that need short-circuit protection, over-temperature shutdown, etc., the ISL6841 may be substituted with the ISL6721. This evaluation board has been provided with placeholders for primary auxiliary winding feedback to save component cost in case of applications that can tolerate loose regulation requirements.

Target Design Specifications

The following design requirements were targeted for evaluation purposes:

- Switching Frequency, f_{sw} : 200kHz.
- V_{IN} : 18VDC to 30VDC.
- V_{OUT} : 12V with 5% absolute regulation.
- I_{OUT} : 2.5A.
- P_{OUT} : 30W.
- Full Load Efficiency: 80% minimum under all line conditions, and loads of 20% and above.
- Ripple: 1% of output voltage.
- Form Factor: 2"x2".

The detailed design procedure for a continuous mode flyback topology has been discussed in the application note AN1192, available on Intersil's website:

<http://www.intersil.com/data/an/an1192.pdf>

Typical Performance Characteristics

The major performance criterion for the converter are efficiency, load regulation and low output ripple. As can be observed from the following figures, the 20% load efficiency target of 80% has been comfortably met under all input voltage conditions. Tight load regulation has been achieved by using the opto-coupled feedback scheme.

Waveforms

Typical waveforms can be found in the following Figures. Figure 1 shows the efficiency curves at different input voltages. Figure 2 shows the worst case output voltage ripple and noise.

Figures 3 through 6 show the drain and gate waveforms of the primary FET under different input and loading conditions.

Figures 7 through 10 show the secondary rectifier waveforms under different input and loading conditions.

A measure of the stability can be determined from the Bode plots shown in Figures 11 through 14. As shown, the gain and phase margins under the extreme conditions of line and load indicate a stable system under all operating conditions.

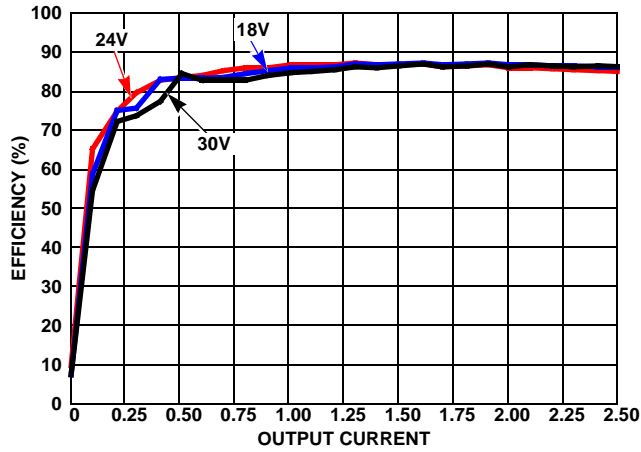

FIGURE 1. EFFICIENCY PLOTS

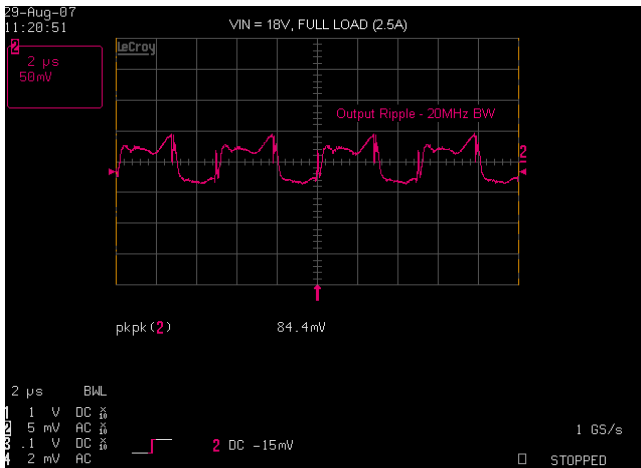

FIGURE 2. OUTPUT RIPPLE AND NOISE, 20MHz BW

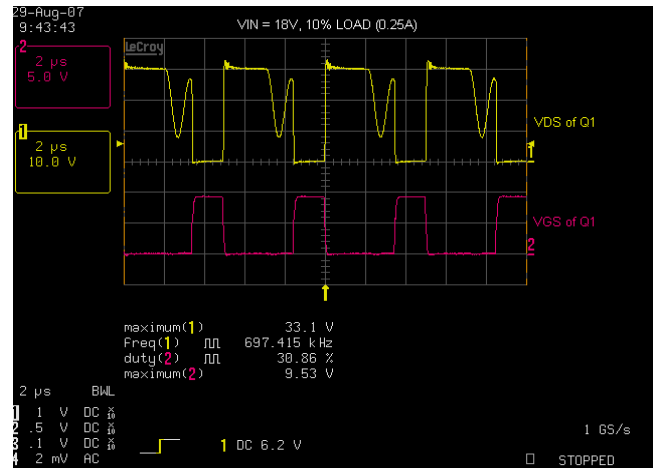

FIGURE 3. FET VOLTAGES, $V_{IN} = 18V$, LOAD = 250mA

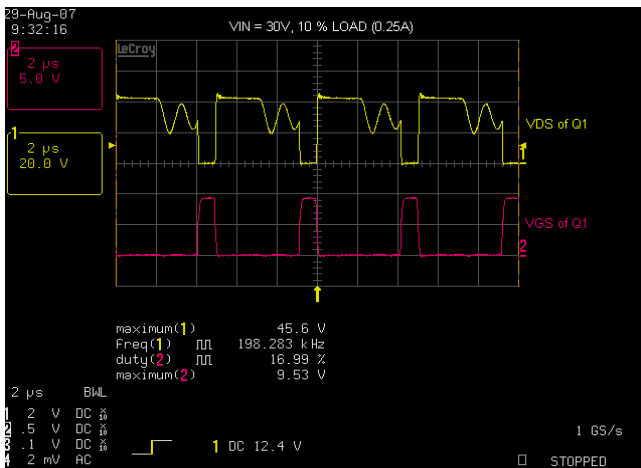

FIGURE 4. FET VOLTAGES, $V_{IN} = 30V$, LOAD = 250mA

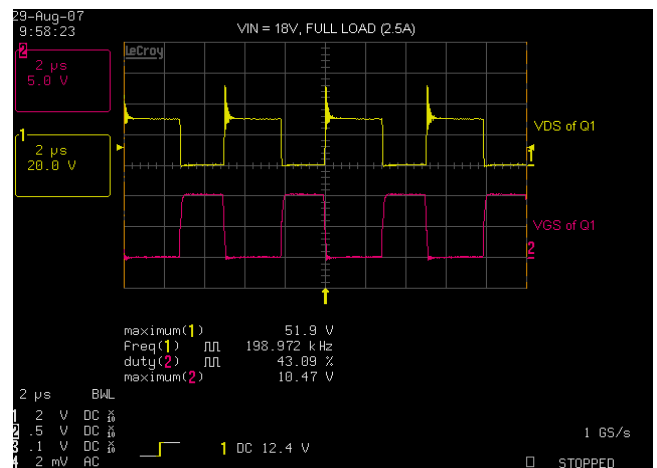

FIGURE 5. FET VOLTAGES, $V_{IN} = 18V$, LOAD = 2.5A

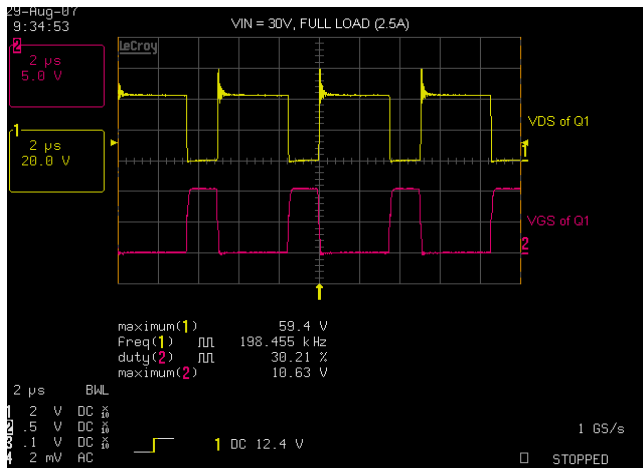

FIGURE 6. FET VOLTAGES, $V_{IN} = 30V$, LOAD = 2.5A

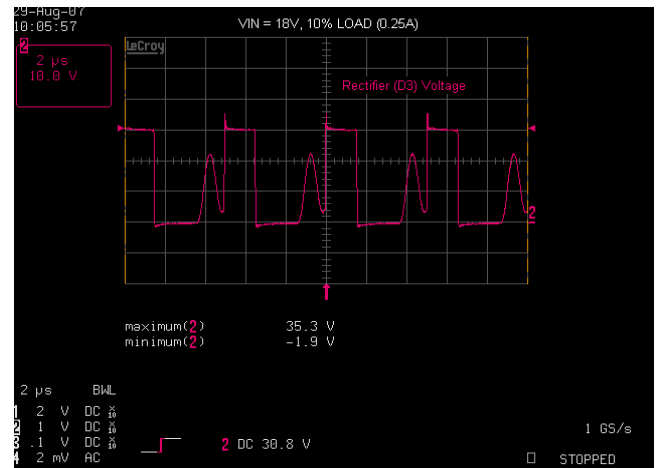

FIGURE 7. RECTIFIER WAVEFORM, $V_{IN} = 18V$, LOAD = 250mA

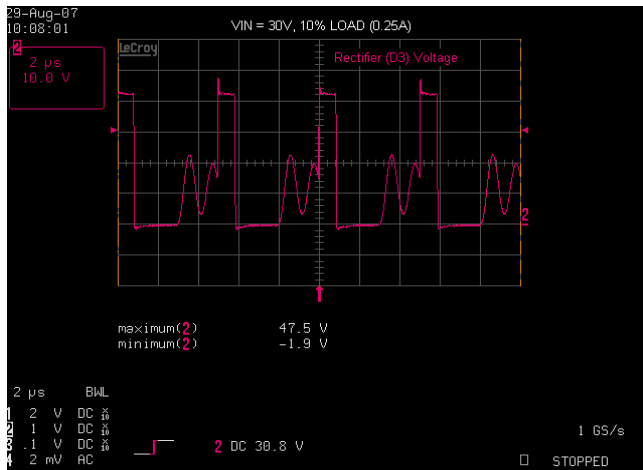

FIGURE 8. RECTIFIER WAVEFORM, $V_{IN} = 30V$, LOAD = 250mA

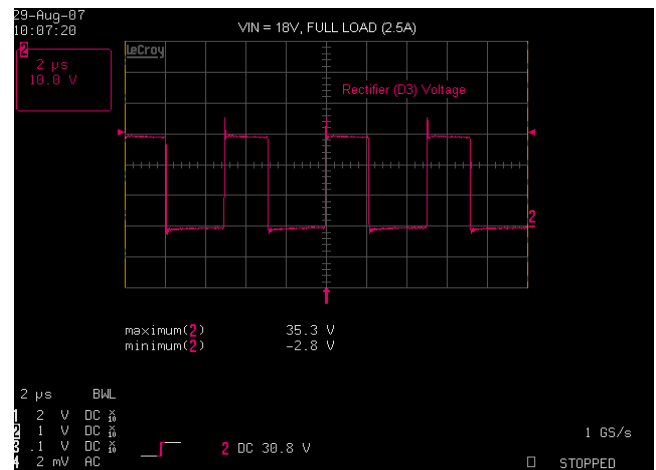

FIGURE 9. RECTIFIER WAVEFORM, $V_{IN} = 18V$, LOAD = 2.5A

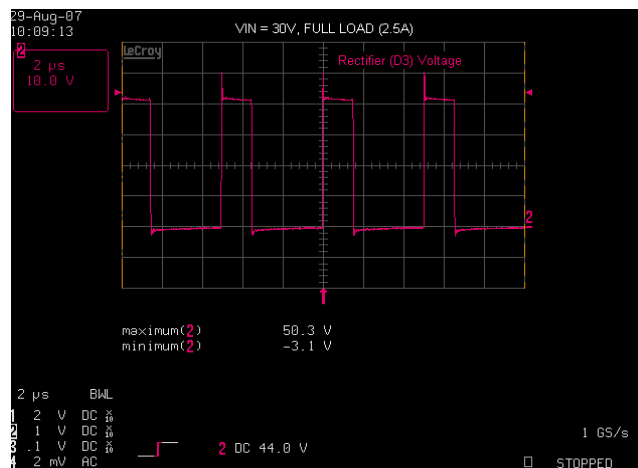

FIGURE 10. RECTIFIER WAVEFORM, $V_{IN} = 30V$, LOAD = 2.5A

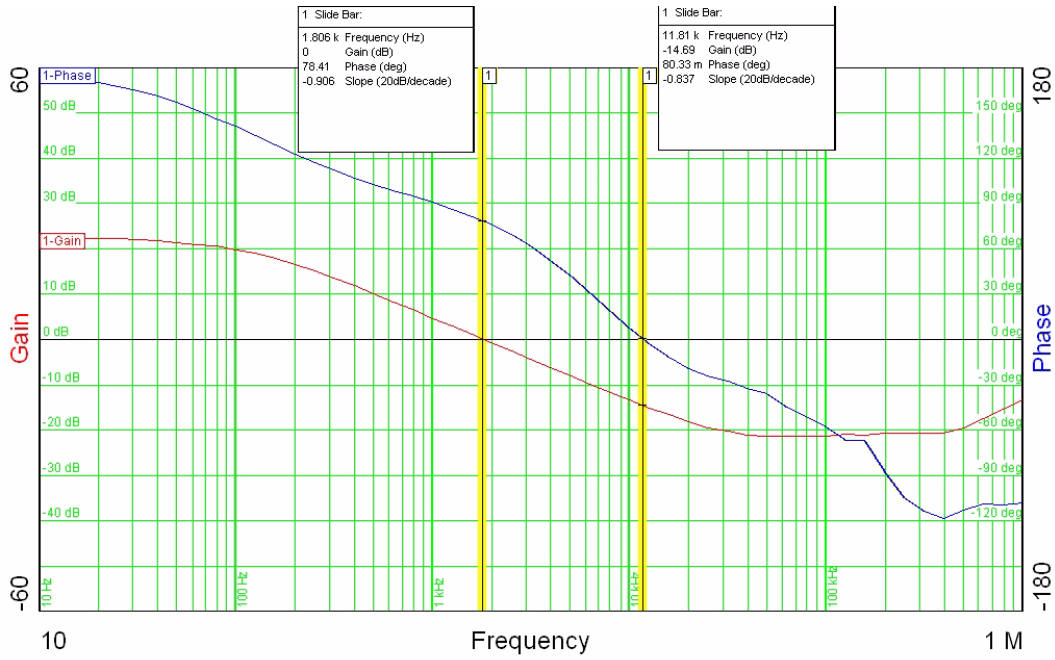

FIGURE 11. STABILITY ANALYSIS, $V_{IN} = 18V$, FULL LOAD

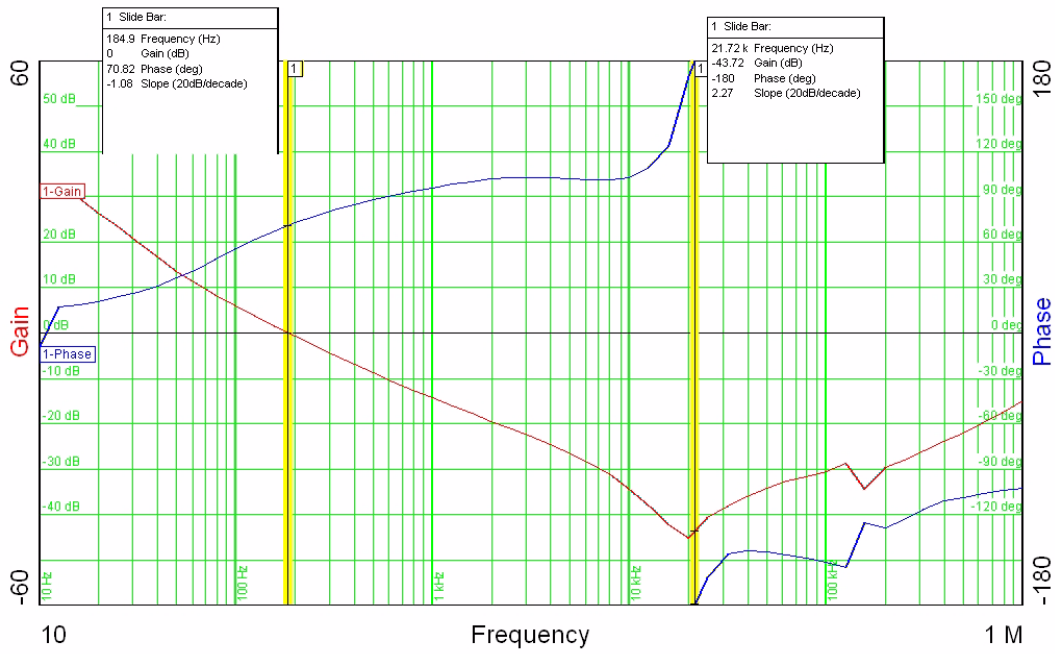

FIGURE 12. STABILITY ANALYSIS, $V_{IN} = 18V$, NO LOAD

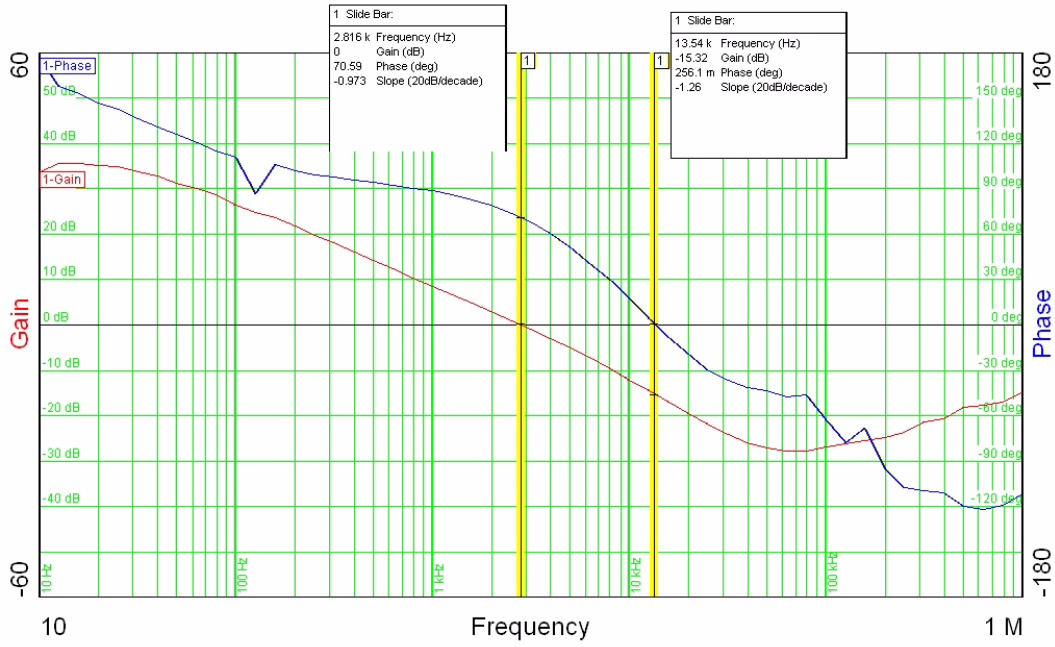

FIGURE 13. STABILITY ANALYSIS, $V_{IN} = 30V$, FULL LOAD

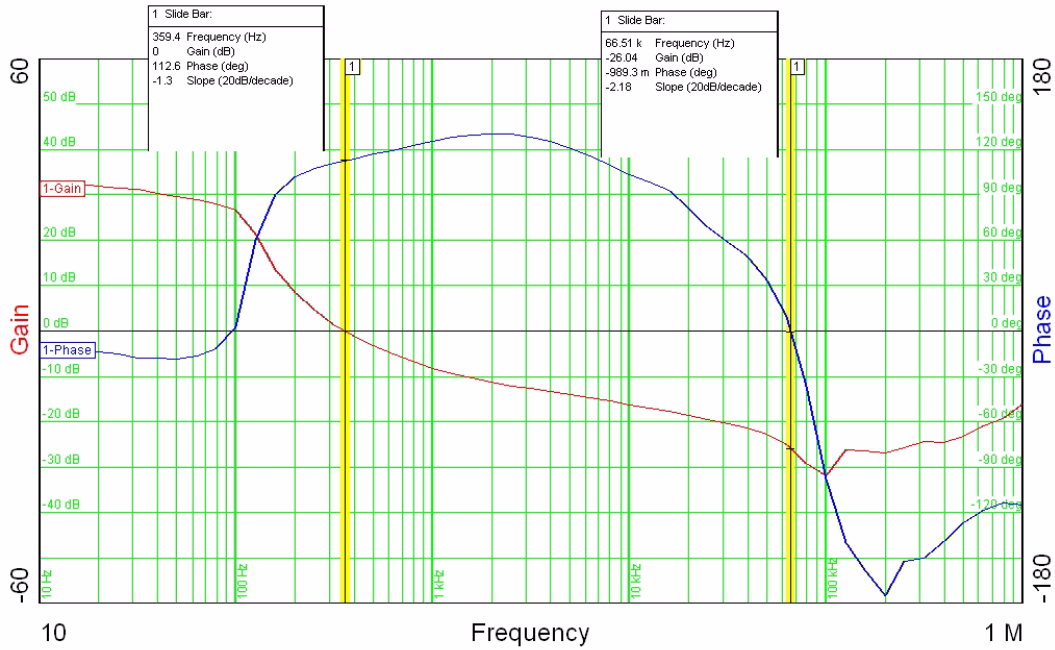
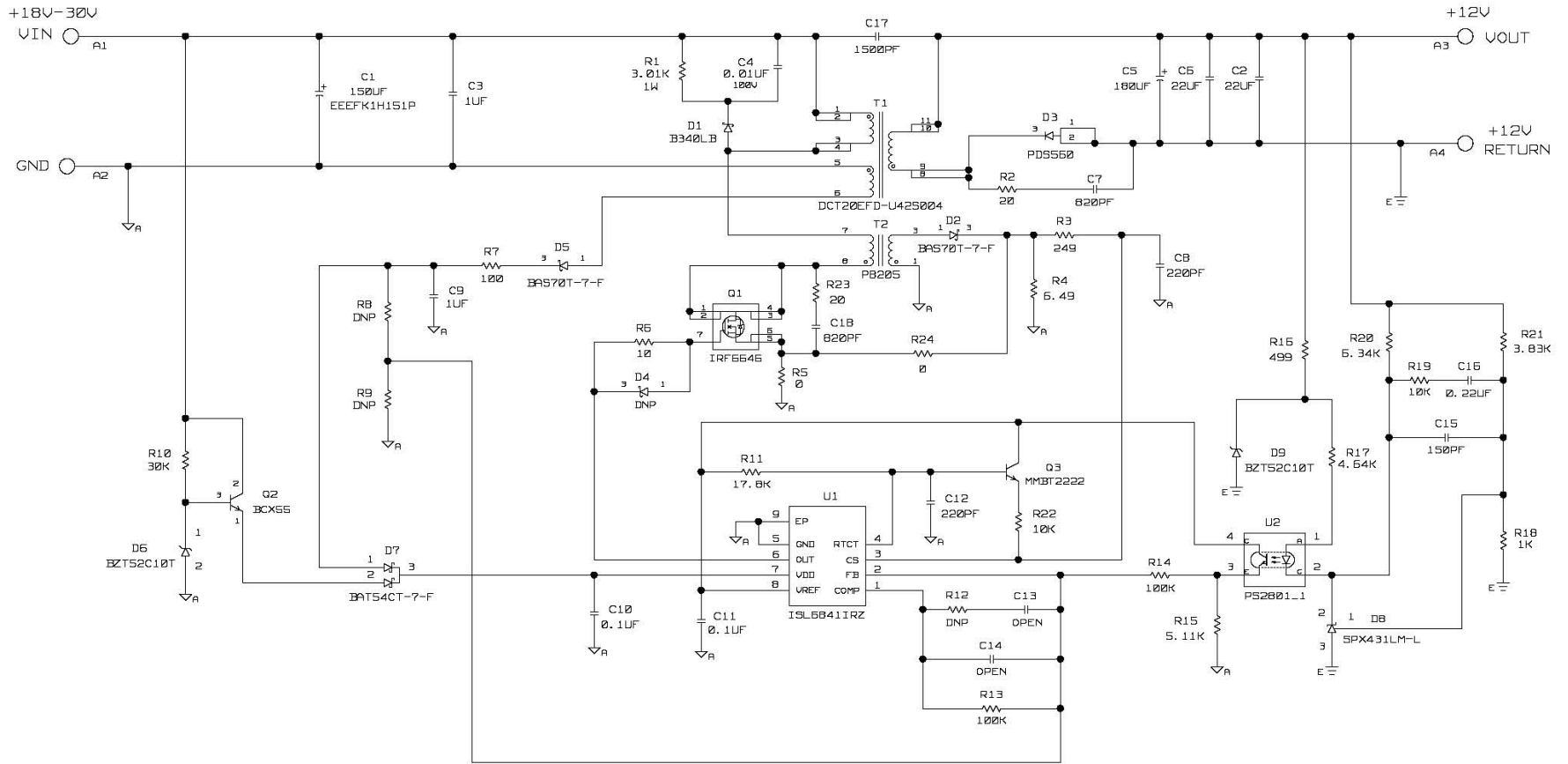

FIGURE 14. STABILITY ANALYSIS, $V_{IN} = 30V$, NO LOAD

ISL6841EVAL3Z Schematic



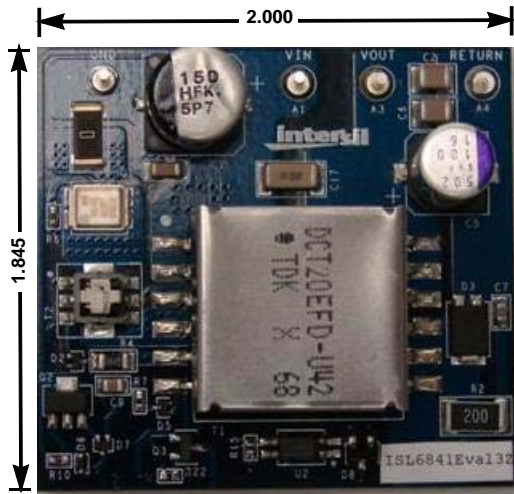

FIGURE 15. TOP VIEW - ISL6841EVAL3Z BOARD

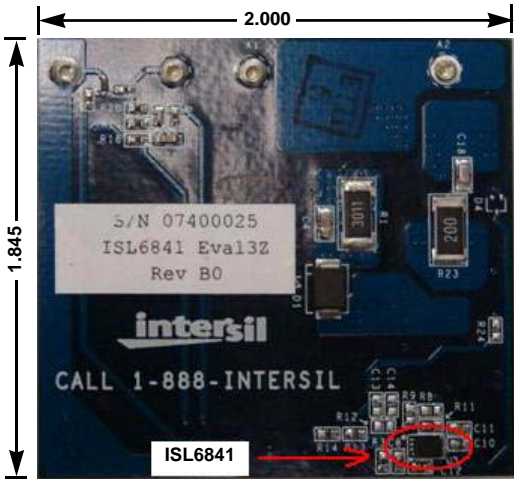

FIGURE 16. BOTTOM VIEW - ISL6841EVAL3Z BOARD

Circuit Elements

Input Filtering Capacitance – C₁, C₃

Isolation Transformer – T1

Power MOSFET – Q₁

Current Sense Network – T₂, D₂, R₄, R₃, C₈ (R₅ optional)

Start-up Bias Circuit – R₁₀, Q₂, D₆

Operating Bias Circuit – D₅, R₇, C₉, D₇

Control Circuit – U₁, C₁₀, C₁₁, R₁₁, C₁₂, R₆

Conventional Rectification Diode – D₃

Output Filtering – C₅, C₆, C₂

Feedback Network – R₁₃, R₁₄, R₁₅, R₁₆, R₁₇, R₁₈, R₁₉, R₂₀, R₂₁, D₈, D₉, C₁₅, C₁₆, U₂

Slope Compensation - Q₃, R₂₂

Primary RCD Snubber - R₁, D₁, C₄

Primary FET Snubber - R₂₃, C₁₈

Secondary Rectifier Snubber - R₂, C₇

Safety Capacitor - C₁₇

Optional Circuit for Primary Auxiliary Feedback - R₈, R₉, R₁₂, C₁₃, C₁₄

Summary

Using a high performance, low-cost PWM controller with a low pin-count, all the design targets have been achieved, while keeping the cost to a minimum. The ISL6841EVAL3Z schematic and BOM for the evaluation board are provided as follows. Please contact our Technical Support Center for custom output voltage requirements. They can be reached through Intersil's website at:

<http://www.intersil.com/cda/home/> or via phone at 1-888-INTERSIL.

Application Note 1384

Component List

REFERENCE DESIGNATOR	VENDOR	PART NUMBER	DESCRIPTION
C1	Panasonic	EEE-FK1H151P	CAP, SMD, 10.3mm, 150µF, 50V, 20%, ROHS, ALUM.ELEC.
C2, C6	TDK/Murata		CAP, SMD, 1210, 22µF, 16V, 20%, X7R, ROHS
C3	TDK/Murata		CAP, SMD, 1206, 1µF, 50V, 10%, X7R, ROHS
C4	TDK/Murata		CAP, SMD, 0805, 0.01µF, 100V, 10%, X7R, ROHS
C5	Sanyo	16SVP180M	CAP, SMD, E12, 180µF, 16V, 20%, OSCON, ROHS
C7, C18	TDK/Murata		CAP, SMD, 0805, 820pF, 100V, 5%, NPO, ROHS
C8, C12	TDK/Murata		CAP, SMD, 0402, 220pF, 50V, 5%, NPO, ROHS
C9	TDK/Murata		CAP, SMD, 0805, 1.0µF, 25V, 10%, X7R, ROHS
C10, C11	TDK/Murata		CAP, SMD, 0402, 0.1µF, 16V, 10%, X7R, ROHS
C15	TDK/Murata		CAP, SMD, 0402, 150pF, 50V, 5%, NPO, ROHS
C16	TDK/Murata		CAP, SMD, 0603, 0.22µF, 16V, 10%, X7R, ROHS
C17	Murata	GA352QR7GF152KW01L	CAP, SMD, 2220, 1500pF, 250V, 10%, X7R, ROHS
D1	Diodes	B340LB-13-F	DIODE-SCHOTTKY, SMD, SMB, 2P, 40V, 3A LOW VF, ROHS
D2, D5	Diodes	BAS70T-7-F	DIODE-SCHOTTKY, SMD, SOT-523, 70V, 70mA, ROHS
D3	Diodes	PDS560-13	DIODE-RECTIFIER, SMD, POWER DI5, 3P, 60V, 5A, ROHS
D6, D9	Diodes	BZT52C10T-7	DIODE-ZENER, SMD, SOD-523, 10V, 150mW, ROHS
D7	Diodes	BAT54CT-7-F	DIODE-SCHOTTKY, SMD, SOT-523, 30V, 200mA, DUAL DIODE, ROHS
D8	Sipex	SPX431LM-L	IC-ADJ. PREC.SHUNT REGULATOR, 3P, SOT-23, ROHS
Q1	International Rectifier	IRF6646	TRANSISTOR-MOS, N-CHANNEL, SMD, DIRECTFET-MN, 80V, 12A, ROHS
Q2	Diodes	BCX55-16	TRANSISTOR, NPN, SMD, SOT-89, 4P, 60V, 1A, ROHS
Q3	On Semi	MMBT2222ALT1G-T	TRANSISTOR, NPN, 3LD, SOT23, 40V, 600mA, ROHS
R1			RES, SMD, 2512, 3.01k, 1W, 1%, TF, ROHS
R2, R23			RES, SMD, 2512, 20Ω, 1W, 5%, TF, ROHS
R3			RES, SMD, 0402, 249Ω, 1/16W, 1%, TF, ROHS
R4			RES-CURR.SENSE, SMD, 1206, 6.49Ω, 1/4W, 1%, ROHS
R5			RES, SMD, 2512, 0Ω, 1W, TF, ROHS
R6			RES, SMD, 0402, 10Ω, 1/16W, 1%, TF, ROHS
R7			RES, SMD, 0402, 100Ω, 1/16W, 1%, TF, ROHS
R10			RES, SMD, 0402, 30k, 1/16W, 5%, TF, ROHS
R11			RES, SMD, 0402, 17.8k, 1/16W, 1%, TF, ROHS
R13, R14			RES, SMD, 0402, 100k, 1/16W, 1%, TF, ROHS
R15			RES, SMD, 0402, 5.11k, 1/16W, 1%, TF, ROHS
R16			RES, SMD, 0402, 499Ω, 1/16W, 1%, TF, ROHS
R17			RES, SMD, 0402, 4.64k, 1/16W, 1%, TF, ROHS
R18			RES, SMD, 0402, 1k, 1/16W, 1%, TF, ROHS

Application Note 1384

Component List (Continued)

REFERENCE DESIGNATOR	VENDOR	PART NUMBER	DESCRIPTION
R19, R22			RES, SMD, 0402, 10k, 1/16W, 1%, TF, ROHS
R20			RES, SMD, 0402, 6.34k, 1/16W, 1%, TF, ROHS
R21			RES, SMD, 0402, 3.83k, 1/16W, 1%, TF, ROHS
T1	TDK	DCT20EFD-U42S004	TRANSFORMER-FLYBACK, SMD, 20µH, CUSTOM, ROHS
T2	Pulse	P8205NL	TRANSFORMER-CURRENT SENSE, SMD, 8P, 500µH, 10A, ROHS
U1	Intersil	ISL6841IRZ	IC-CURRENT MODE PWM CONTROLLER, 8P, DFN, 2x3, ROHS
U2	California Eastern Laboratories	PS2801-1-A	IC-PHOTOCOUPLER, 4P, SSOP, ROHS

Layout

The ISL6841EVAL3Z board met the form factor target with room to spare. Following are the layout pictures of the board. The gerber files are available upon request.

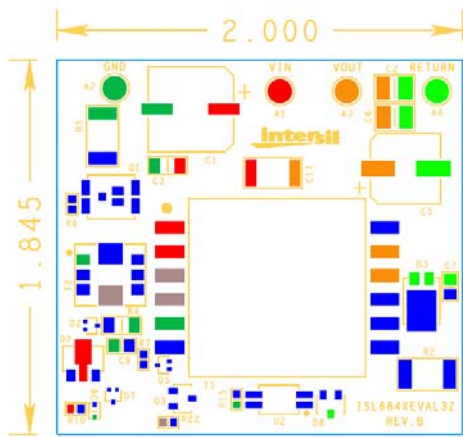

FIGURE 17. SILKSCREEN - TOP LAYER

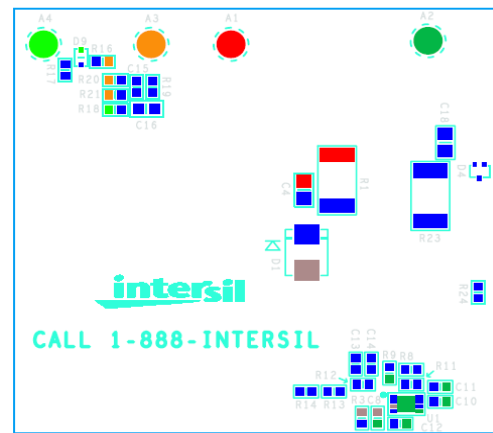

FIGURE 18. SILKSCREEN - BOTTOM LAYER

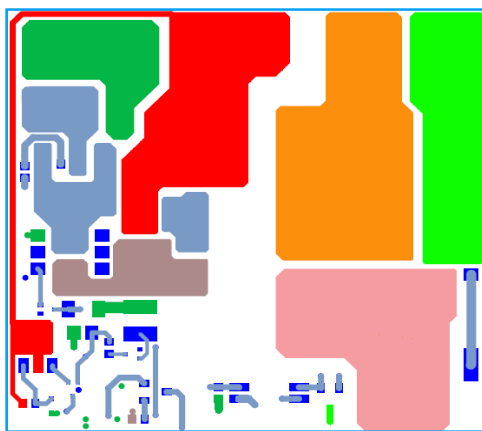

FIGURE 19. ETCH - TOP LAYER

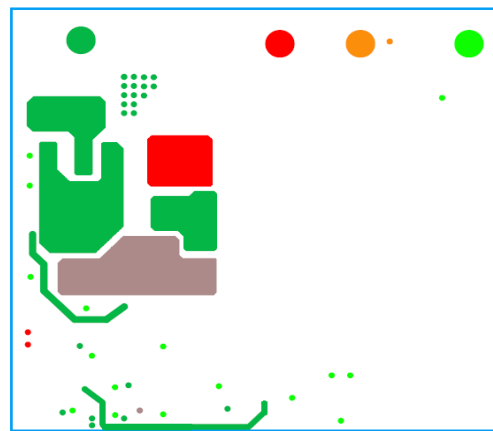

FIGURE 20. ETCH - LAYER 2

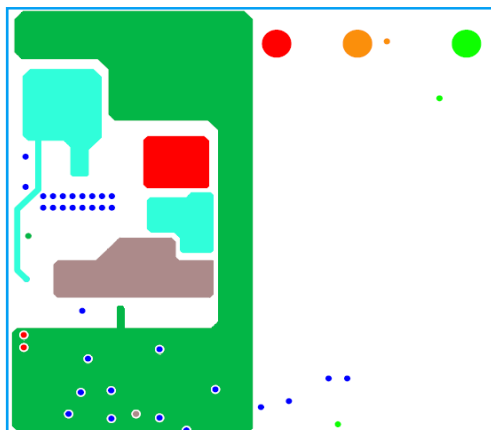

FIGURE 21. ETCH - LAYER 3

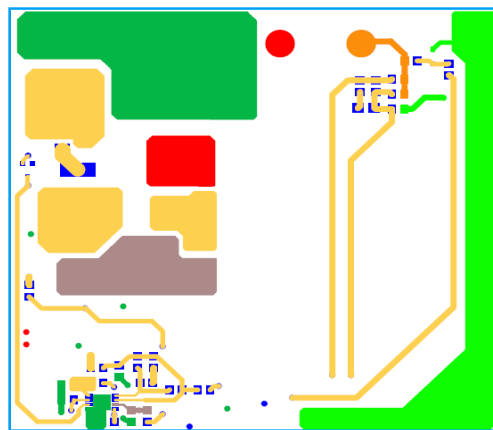

FIGURE 22. ETCH - BOTTOM LAYER

Intersil Corporation reserves the right to make changes in circuit design, software and/or specifications at any time without notice. Accordingly, the reader is cautioned to verify that the Application Note or Technical Brief is current before proceeding.

For information regarding Intersil Corporation and its products, see www.intersil.com