

## Important notice

Dear Customer,

On 7 February 2017 the former NXP Standard Product business became a new company with the tradename **Nexperia**. Nexperia is an industry leading supplier of Discrete, Logic and PowerMOS semiconductors with its focus on the automotive, industrial, computing, consumer and wearable application markets

In data sheets and application notes which still contain NXP or Philips Semiconductors references, use the references to Nexperia, as shown below.

Instead of <http://www.nxp.com>, <http://www.philips.com/> or <http://www.semiconductors.philips.com/>, use <http://www.nexperia.com>

Instead of [sales.addresses@www.nxp.com](mailto:sales.addresses@www.nxp.com) or [sales.addresses@www.semiconductors.philips.com](mailto:sales.addresses@www.semiconductors.philips.com), use [salesaddresses@nexperia.com](mailto:salesaddresses@nexperia.com) (email)

Replace the copyright notice at the bottom of each page or elsewhere in the document, depending on the version, as shown below:

- © NXP N.V. (year). All rights reserved or © Koninklijke Philips Electronics N.V. (year). All rights reserved

Should be replaced with:

- © **Nexperia B.V. (year). All rights reserved.**

If you have any questions related to the data sheet, please contact our nearest sales office via e-mail or telephone (details via [salesaddresses@nexperia.com](mailto:salesaddresses@nexperia.com)). Thank you for your cooperation and understanding,

Kind regards,

Team Nexperia

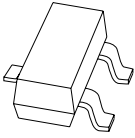

# PMBT3906

PNP switching transistor

Rev. 06 — 2 March 2010

Product data sheet

## 1. Product profile

### 1.1 General description

PNP switching transistor in a SOT23 (TO-236AB) small Surface-Mounted Device (SMD) plastic package.

NPN complement: PMBT3904.

### 1.2 Features and benefits

- Collector-emitter voltage  $V_{CEO} = -40$  V
- Collector current capability  $I_C = -200$  mA

### 1.3 Applications

- General amplification and switching

### 1.4 Quick reference data

Table 1. Quick reference data

| Symbol    | Parameter                 | Conditions | Min | Typ | Max  | Unit |
|-----------|---------------------------|------------|-----|-----|------|------|
| $V_{CEO}$ | collector-emitter voltage | open base  | -   | -   | -40  | V    |
| $I_C$     | collector current         |            | -   | -   | -200 | mA   |

## 2. Pinning information

Table 2. Pinning

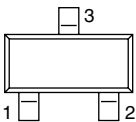
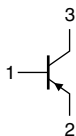
| Pin | Description | Simplified outline  | Graphic symbol  |
|-----|-------------|---|---|
| 1   | base        |  |  |
| 2   | emitter     |   |   |
| 3   | collector   |   |   |

006aab25



### 3. Ordering information

Table 3. Ordering information

| Type number | Package |  |         |
|-------------|---------|--|---------|
|             | Name    | Description                              | Version |
| PMBT3906    | -       | plastic surface-mounted package; 3 leads | SOT23   |

### 4. Marking

Table 4. Marking codes

| Type number | Marking code <sup>[1]</sup> |
|-------------|-----------------------------|
| PMBT3906    | *2A                         |

- [1] \* = -: made in Hong Kong  
 \* = p: made in Hong Kong  
 \* = t: made in Malaysia  
 \* = W: made in China

### 5. Limiting values

Table 5. Limiting values

In accordance with the Absolute Maximum Rating System (IEC 60134).

| Symbol    | Parameter                 | Conditions                  | Min              | Max  | Unit |
|-----------|---------------------------|-----------------------------|------------------|------|------|
| $V_{CBO}$ | collector-base voltage    | open emitter                | -                | -40  | V    |
| $V_{CEO}$ | collector-emitter voltage | open base                   | -                | -40  | V    |
| $V_{EBO}$ | emitter-base voltage      | open collector              | -                | -6   | V    |
| $I_C$     | collector current         |                             | -                | -200 | mA   |
| $I_{CM}$  | peak collector current    |                             | -                | -200 | mA   |
| $I_{BM}$  | peak base current         |                             | -                | -100 | mA   |
| $P_{tot}$ | total power dissipation   | $T_{amb} \leq 25\text{ °C}$ | <sup>[1]</sup> - | 250  | mW   |
| $T_j$     | junction temperature      |                             | -                | 150  | °C   |
| $T_{amb}$ | ambient temperature       |                             | -65              | +150 | °C   |
| $T_{stg}$ | storage temperature       |                             | -65              | +150 | °C   |

- [1] Device mounted on an FR4 Printed-Circuit Board (PCB).

## 6. Thermal characteristics

**Table 6. Thermal characteristics**

| Symbol        | Parameter                                   | Conditions  | Min | Typ | Max | Unit |
|---------------|---|-------------|-----|-----|-----|------|
| $R_{th(j-a)}$ | thermal resistance from junction to ambient | in free air | [1] | -   | 500 | K/W  |

[1] Device mounted on an FR4 PCB.

## 7. Characteristics

**Table 7. Characteristics**

$T_{amb} = 25\text{ }^{\circ}\text{C}$  unless otherwise specified.

| Symbol      | Parameter                            | Conditions   | Min | Typ | Max  | Unit |
|-------------|--------------------------------------|--|-----|-----|------|------|
| $I_{CBO}$   | collector-base cut-off current       | $V_{CB} = -30\text{ V}; I_E = 0\text{ A}$  | -   | -   | -50  | nA   |
| $I_{EBO}$   | emitter-base cut-off current         | $V_{EB} = -6\text{ V}; I_C = 0\text{ A}$   | -   | -   | -50  | nA   |
| $h_{FE}$    | DC current gain                      | $V_{CE} = -1\text{ V}$   |     |     |      |      |
|             |                                      | $I_C = -0.1\text{ mA}$   | 60  | -   | -    |      |
|             |                                      | $I_C = -1\text{ mA}$   | 80  | -   | -    |      |
|             |                                      | $I_C = -10\text{ mA}$  | 100 | -   | 300  |      |
|             |                                      | $I_C = -50\text{ mA}$  | 60  | -   | -    |      |
|             |                                      | $I_C = -100\text{ mA}$   | 30  | -   | -    |      |
| $V_{CEsat}$ | collector-emitter saturation voltage | $I_C = -10\text{ mA}; I_B = -1\text{ mA}$  | -   | -   | -250 | mV   |
|             |                                      | $I_C = -50\text{ mA}; I_B = -5\text{ mA}$  | -   | -   | -400 | mV   |
| $V_{BEsat}$ | base-emitter saturation voltage      | $I_C = -10\text{ mA}; I_B = -1\text{ mA}$  | -   | -   | -850 | mV   |
|             |                                      | $I_C = -50\text{ mA}; I_B = -5\text{ mA}$  | -   | -   | -950 | mV   |
| $t_d$       | delay time                           | $I_{Con} = -10\text{ mA};$   | -   | -   | 35   | ns   |
| $t_r$       | rise time                            | $I_{Bon} = -1\text{ mA};$  | -   | -   | 35   | ns   |
| $t_{on}$    | turn-on time                         | $I_{Boff} = 1\text{ mA}$   | -   | -   | 70   | ns   |
| $t_s$       | storage time                         |  | -   | -   | 225  | ns   |
| $t_f$       | fall time                            |  | -   | -   | 75   | ns   |
| $t_{off}$   | turn-off time                        |  | -   | -   | 300  | ns   |
| $f_T$       | transition frequency                 | $V_{CE} = -20\text{ V};$<br>$I_C = -10\text{ mA};$<br>$f = 100\text{ MHz}$   | 250 | -   | -    | MHz  |
| $C_C$       | collector capacitance                | $V_{CB} = -5\text{ V}; I_E = I_C = 0\text{ A};$<br>$f = 1\text{ MHz}$  | -   | -   | 4.5  | pF   |
| $C_e$       | emitter capacitance                  | $V_{EB} = -500\text{ mV};$<br>$I_C = I_E = 0\text{ A}; f = 1\text{ MHz}$   | -   | -   | 10   | pF   |
| NF          | noise figure                         | $I_C = -100\text{ }\mu\text{A};$<br>$V_{CE} = -5\text{ V}; R_S = 1\text{ k}\Omega;$<br>$f = 10\text{ Hz to }15.7\text{ kHz}$ | -   | -   | 4    | dB   |

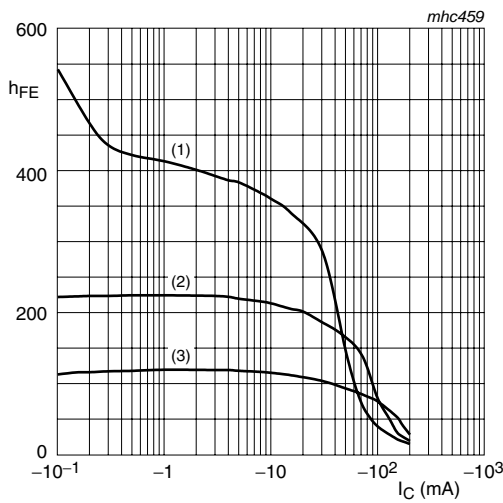

$V_{CE} = -1\text{ V}$   
 (1)  $T_{amb} = 150\text{ °C}$   
 (2)  $T_{amb} = 25\text{ °C}$   
 (3)  $T_{amb} = -55\text{ °C}$

**Fig 1. DC current gain as a function of collector current; typical values**

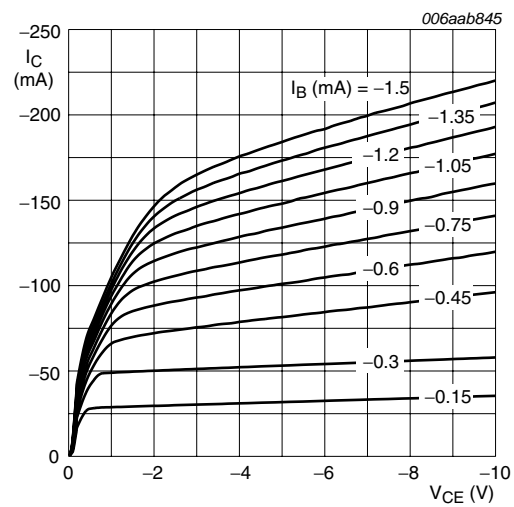

$T_{amb} = 25\text{ °C}$

**Fig 2. Collector current as a function of collector-emitter voltage; typical values**

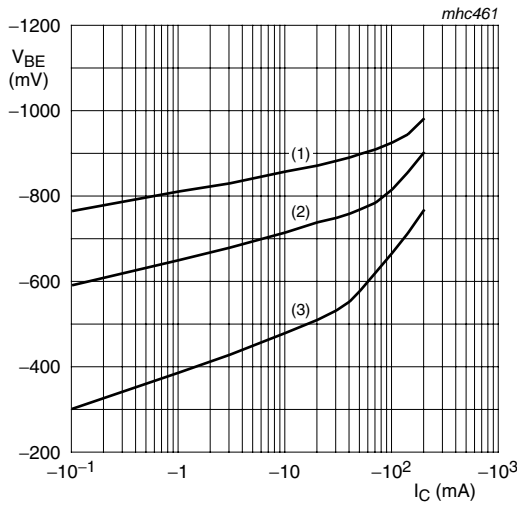

$V_{CE} = -1\text{ V}$   
 (1)  $T_{amb} = -55\text{ °C}$   
 (2)  $T_{amb} = 25\text{ °C}$   
 (3)  $T_{amb} = 150\text{ °C}$

**Fig 3. Base-emitter voltage as a function of collector current; typical values**

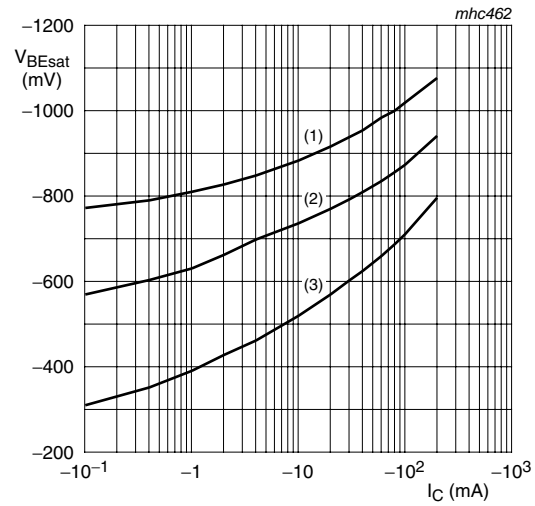

$I_C/I_B = 10$   
 (1)  $T_{amb} = -55\text{ °C}$   
 (2)  $T_{amb} = 25\text{ °C}$   
 (3)  $T_{amb} = 150\text{ °C}$

**Fig 4. Base-emitter saturation voltage as a function of collector current; typical values**

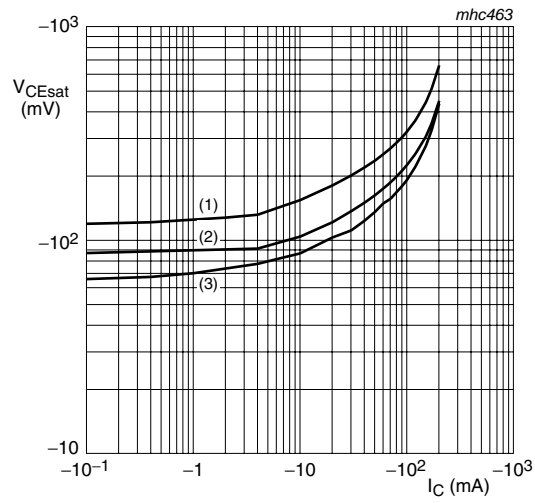

- $I_C/I_B = 10$
- (1)  $T_{amb} = 150\text{ °C}$
  - (2)  $T_{amb} = 25\text{ °C}$
  - (3)  $T_{amb} = -55\text{ °C}$

**Fig 5. Collector-emitter saturation voltage as a function of collector current; typical values**

**8. Test information**

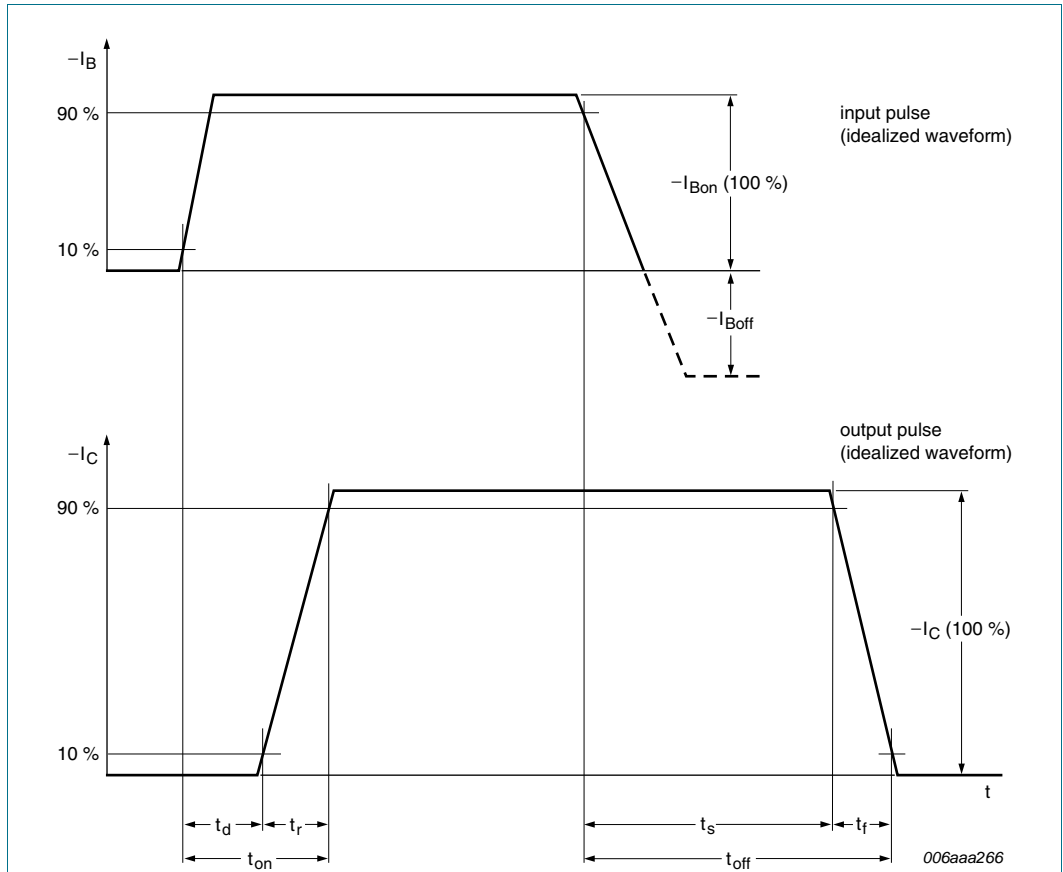

**Fig 6. BISS transistor switching time definition**

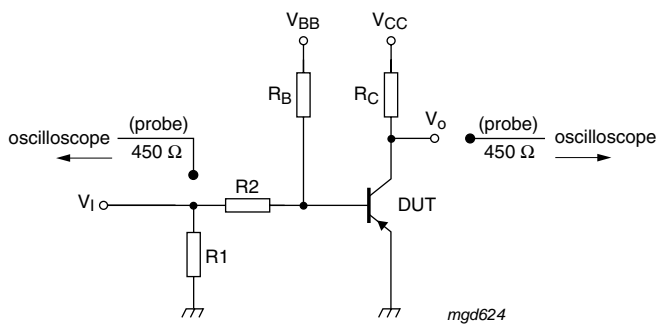

$V_I = 5 \text{ V}$ ;  $T = 500 \text{ } \mu\text{s}$ ;  $t_p = 10 \text{ } \mu\text{s}$ ;  $t_r = t_f \leq 3 \text{ ns}$   
 $R1 = 56 \text{ } \Omega$ ;  $R2 = 2.5 \text{ k}\Omega$ ;  $R_B = 3.9 \text{ k}\Omega$ ;  $R_C = 270 \text{ } \Omega$   
 $V_{BB} = 1.9 \text{ V}$ ;  $V_{CC} = -3 \text{ V}$   
 Oscilloscope: input impedance  $Z_i = 50 \text{ } \Omega$

**Fig 7. Test circuit for switching times**

## 9. Package outline

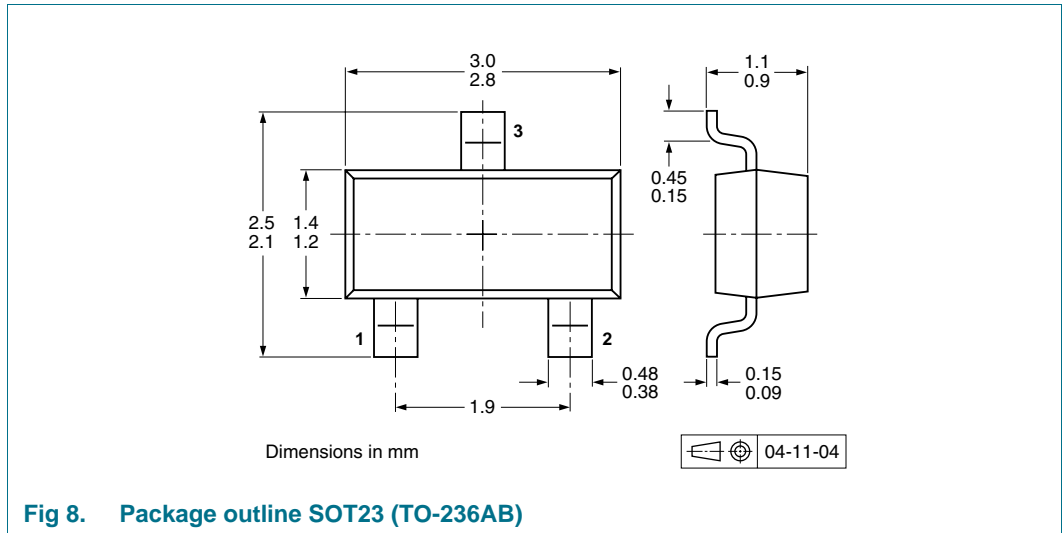

## 10. Packing information

**Table 8. Packing methods**

The indicated -xxx are the last three digits of the 12NC ordering code.<sup>[1]</sup>

| Type number | Package | Description                    | Packing quantity |       |
|-------------|---------|--------------------------------|------------------|-------|
|             |         |                                | 3000             | 10000 |
| PMBT3906    | SOT23   | 4 mm pitch, 8 mm tape and reel | -215             | -235  |

[1] For further information and the availability of packing methods, see [Section 13](#).



## 11. Revision history

**Table 9.** Revision history

| Document ID    | Release date  | Data sheet status     | Change notice | Supersedes     |
|----------------|---|-----------------------|---------------|----------------|
| PMBT3906_6     | 20100302  | Product data sheet    | -             | PMBT3906_N_5   |
| Modifications: | <ul style="list-style-type: none"> <li>• The format of this data sheet has been redesigned to comply with the new identity guidelines of NXP Semiconductors.</li> <li>• Legal texts have been adapted to the new company name where appropriate.</li> <li>• <a href="#">Section 4 “Marking”</a>: amended</li> <li>• <a href="#">Table 7 “Characteristics”</a>: F redefined to NF noise figure</li> <li>• <a href="#">Section 8 “Test information”</a>: added</li> <li>• <a href="#">Figure 6</a>: added</li> <li>• <a href="#">Figure 8</a>: superseded by minimized package outline drawing</li> <li>• <a href="#">Section 10 “Packing information”</a>: added</li> <li>• <a href="#">Section 12 “Legal information”</a>: updated</li> </ul> |                       |               |                |
| PMBT3906_N_5   | 20071004  | Product data sheet    | -             | PMBT3906_4     |
| PMBT3906_4     | 20040121  | Product specification | -             | PMBT3906_3     |
| PMBT3906_3     | 19990427  | Product specification | -             | PMBT3906_CNV_2 |
| PMBT3906_CNV_2 | 19970505  | Product specification | -             | -              |

## 12. Legal information

### 12.1 Data sheet status

| Document status <sup>[1][2]</sup> | Product status <sup>[3]</sup> | Definition  |
|-----------------------------------|-------------------------------|---|
| Objective [short] data sheet      | Development                   | This document contains data from the objective specification for product development. |
| Preliminary [short] data sheet    | Qualification                 | This document contains data from the preliminary specification.                       |
| Product [short] data sheet        | Production                    | This document contains the product specification.                                     |

[1] Please consult the most recently issued document before initiating or completing a design.

[2] The term 'short data sheet' is explained in section "Definitions".

[3] The product status of device(s) described in this document may have changed since this document was published and may differ in case of multiple devices. The latest product status information is available on the Internet at URL <http://www.nxp.com>.

### 12.2 Definitions

**Draft** — The document is a draft version only. The content is still under internal review and subject to formal approval, which may result in modifications or additions. NXP Semiconductors does not give any representations or warranties as to the accuracy or completeness of information included herein and shall have no liability for the consequences of use of such information.

**Short data sheet** — A short data sheet is an extract from a full data sheet with the same product type number(s) and title. A short data sheet is intended for quick reference only and should not be relied upon to contain detailed and full information. For detailed and full information see the relevant full data sheet, which is available on request via the local NXP Semiconductors sales office. In case of any inconsistency or conflict with the short data sheet, the full data sheet shall prevail.

**Product specification** — The information and data provided in a Product data sheet shall define the specification of the product as agreed between NXP Semiconductors and its customer, unless NXP Semiconductors and customer have explicitly agreed otherwise in writing. In no event however, shall an agreement be valid in which the NXP Semiconductors product is deemed to offer functions and qualities beyond those described in the Product data sheet.

### 12.3 Disclaimers

**Limited warranty and liability** — Information in this document is believed to be accurate and reliable. However, NXP Semiconductors does not give any representations or warranties, expressed or implied, as to the accuracy or completeness of such information and shall have no liability for the consequences of use of such information.

In no event shall NXP Semiconductors be liable for any indirect, incidental, punitive, special or consequential damages (including - without limitation - lost profits, lost savings, business interruption, costs related to the removal or replacement of any products or rework charges) whether or not such damages are based on tort (including negligence), warranty, breach of contract or any other legal theory.

Notwithstanding any damages that customer might incur for any reason whatsoever, NXP Semiconductors' aggregate and cumulative liability towards customer for the products described herein shall be limited in accordance with the *Terms and conditions of commercial sale* of NXP Semiconductors.

**Right to make changes** — NXP Semiconductors reserves the right to make changes to information published in this document, including without limitation specifications and product descriptions, at any time and without notice. This document supersedes and replaces all information supplied prior to the publication hereof.

**Suitability for use** — NXP Semiconductors products are not designed, authorized or warranted to be suitable for use in medical, military, aircraft, space or life support equipment, nor in applications where failure or

malfunction of an NXP Semiconductors product can reasonably be expected to result in personal injury, death or severe property or environmental damage. NXP Semiconductors accepts no liability for inclusion and/or use of NXP Semiconductors products in such equipment or applications and therefore such inclusion and/or use is at the customer's own risk.

**Applications** — Applications that are described herein for any of these products are for illustrative purposes only. NXP Semiconductors makes no representation or warranty that such applications will be suitable for the specified use without further testing or modification.

NXP Semiconductors does not accept any liability related to any default, damage, costs or problem which is based on a weakness or default in the customer application/use or the application/use of customer's third party customer(s) (hereinafter both referred to as "Application"). It is customer's sole responsibility to check whether the NXP Semiconductors product is suitable and fit for the Application planned. Customer has to do all necessary testing for the Application in order to avoid a default of the Application and the product. NXP Semiconductors does not accept any liability in this respect.

**Limiting values** — Stress above one or more limiting values (as defined in the Absolute Maximum Ratings System of IEC 60134) will cause permanent damage to the device. Limiting values are stress ratings only and (proper) operation of the device at these or any other conditions above those given in the Recommended operating conditions section (if present) or the Characteristics sections of this document is not warranted. Constant or repeated exposure to limiting values will permanently and irreversibly affect the quality and reliability of the device.

**Terms and conditions of commercial sale** — NXP Semiconductors products are sold subject to the general terms and conditions of commercial sale, as published at <http://www.nxp.com/profile/terms>, unless otherwise agreed in a valid written individual agreement. In case an individual agreement is concluded only the terms and conditions of the respective agreement shall apply. NXP Semiconductors hereby expressly objects to applying the customer's general terms and conditions with regard to the purchase of NXP Semiconductors products by customer.

**No offer to sell or license** — Nothing in this document may be interpreted or construed as an offer to sell products that is open for acceptance or the grant, conveyance or implication of any license under any copyrights, patents or other industrial or intellectual property rights.

**Export control** — This document as well as the item(s) described herein may be subject to export control regulations. Export might require a prior authorization from national authorities.

**Quick reference data** — The Quick reference data is an extract of the product data given in the Limiting values and Characteristics sections of this document, and as such is not complete, exhaustive or legally binding.

### 12.4 Trademarks

Notice: All referenced brands, product names, service names and trademarks are the property of their respective owners.

### 13. Contact information

---

For more information, please visit: <http://www.nxp.com>

For sales office addresses, please send an email to: [salesaddresses@nxp.com](mailto:salesaddresses@nxp.com)

## 14. Contents

|           |  |           |
|-----------|--|-----------|
| <b>1</b>  | <b>Product profile</b> . . . . .         | <b>1</b>  |
| 1.1       | General description . . . . .            | 1         |
| 1.2       | Features and benefits . . . . .          | 1         |
| 1.3       | Applications . . . . .                   | 1         |
| 1.4       | Quick reference data . . . . .           | 1         |
| <b>2</b>  | <b>Pinning information</b> . . . . .     | <b>1</b>  |
| <b>3</b>  | <b>Ordering information</b> . . . . .    | <b>2</b>  |
| <b>4</b>  | <b>Marking</b> . . . . .                 | <b>2</b>  |
| <b>5</b>  | <b>Limiting values</b> . . . . .         | <b>2</b>  |
| <b>6</b>  | <b>Thermal characteristics</b> . . . . . | <b>3</b>  |
| <b>7</b>  | <b>Characteristics</b> . . . . .         | <b>3</b>  |
| <b>8</b>  | <b>Test information</b> . . . . .        | <b>6</b>  |
| <b>9</b>  | <b>Package outline</b> . . . . .         | <b>7</b>  |
| <b>10</b> | <b>Packing information</b> . . . . .     | <b>7</b>  |
| <b>11</b> | <b>Revision history</b> . . . . .        | <b>8</b>  |
| <b>12</b> | <b>Legal information</b> . . . . .       | <b>9</b>  |
| 12.1      | Data sheet status . . . . .              | 9         |
| 12.2      | Definitions . . . . .                    | 9         |
| 12.3      | Disclaimers . . . . .                    | 9         |
| 12.4      | Trademarks . . . . .                     | 9         |
| <b>13</b> | <b>Contact information</b> . . . . .     | <b>10</b> |
| <b>14</b> | <b>Contents</b> . . . . .                | <b>11</b> |

Please be aware that important notices concerning this document and the product(s) described herein, have been included in section 'Legal information'.

© NXP B.V. 2010.

All rights reserved.

For more information, please visit: <http://www.nxp.com>

For sales office addresses, please send an email to: [salesaddresses@nxp.com](mailto:salesaddresses@nxp.com)

Date of release: 2 March 2010

Document identifier: PMBT3906\_6