

**PCB MOUNTING**  
GROUND TERMINALS ARE OPTIONAL

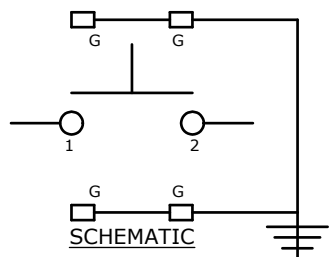

**NOTES:**

1. ALL DIMENSIONS IN MM
2. GENERAL TOLERANCE: X.X=±0.4  
X.XX=±0.25
3. TERM. NOS. FOR REFERENCE ONLY.
4. RATING: 12VDC, 50mA
- ▲ 5. OPERATING FORCE: 160 ± 50 GRAMS
6. TRAVEL: 0.2mm ±0.1
7. CONTACT RESISTANCE: 100 mΩ MAX. (INITIAL)
8. MECHANICAL/ELECTRICAL LIFE 200,000 CYCLES MIN.
9. PACKAGE: TAPE AND REEL - 2500 PIECES PER REEL
10. ▲ DENOTES CRITICAL PARAMETER
11. 2002/95/EC (ROHS) COMPLIANT

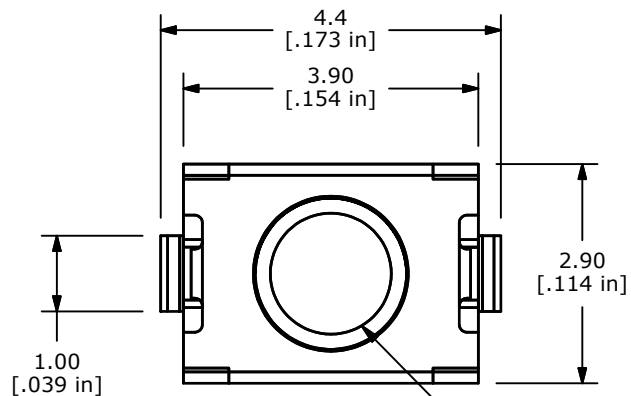

ACTUATOR COLOR: IVORY

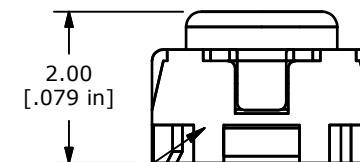
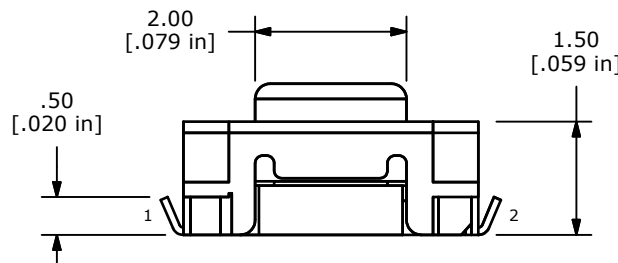
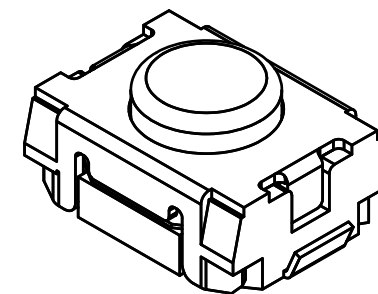

HOUSING COLOR: NATURAL

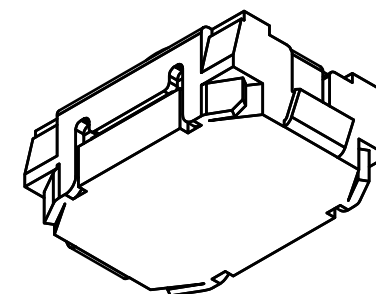
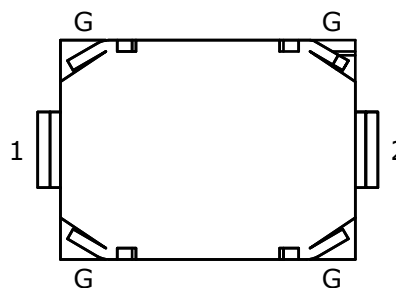

D	21622	ADDED HOUSING COLOR	10/14/14	AS
C	21300	REDRAW	11/13/13	EBP
B	21242	ADDED ACTUATOR COLOR	9/19/13	EBP
A	21000	Released For Production	2/1/2013	rc
REV	PCR NO	DESCRIPTION	DATE	BY

THE INFORMATION CONTAINED IN THIS DOCUMENT IS PROPRIETARY TO E-SWITCH AND IS NOT TO BE COPIED OR TRANSFERRED



TITLE TL1015AF160QG

SCALE	DATE	DR	DWG	REV
10:1	2/1/2013	rc	P420000	D