

Features

- Epitaxial Planar Die Construction
- Complementary NPN Type Available (MMST5551)
- Ideal for Medium Power Amplification and Switching
- Ultra-Small Surface Mount Package
- Available in Lead Free/RoHS Compliant Version (Note 2)

Mechanical Data

- Case: SOT-323
- Case Material: Molded Plastic. UL Flammability Classification Rating 94V-0
- Moisture Sensitivity: Level 1 per J-STD-020C
- Terminal Connections: See Diagram
- Terminals: Solderable per MIL-STD-202, Method 208
- Also Available in Lead Free Plating (Matte Tin Finish annealed over Alloy 42 leadframe). Please see Ordering Information, Note 5, on Page 2
- Marking (See Page 2): K4M
- Ordering & Date Code Information: See Page 2
- Weight: 0.006 grams (approximate)

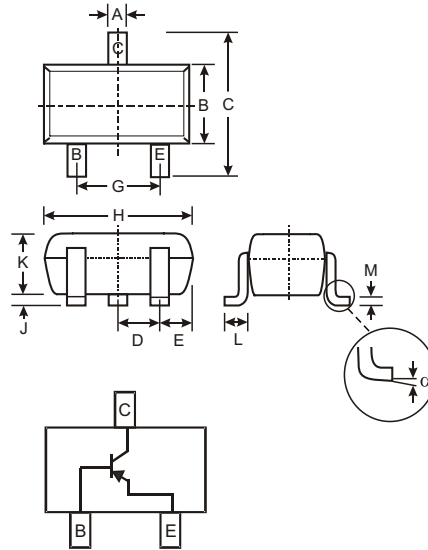

| SOT-323 | | |
|----------------------|--------------|------|
| Dim | Min | Max |
| A | 0.25 | 0.40 |
| B | 1.15 | 1.35 |
| C | 2.00 | 2.20 |
| D | 0.65 Nominal | |
| E | 0.30 | 0.40 |
| G | 1.20 | 1.40 |
| H | 1.80 | 2.20 |
| J | 0.0 | 0.10 |
| K | 0.90 | 1.00 |
| L | 0.25 | 0.40 |
| M | 0.10 | 0.18 |
| α | 0° | 8° |
| All Dimensions in mm | | |

Maximum Ratings @ $T_A = 25^\circ\text{C}$ unless otherwise specified

| Characteristic | Symbol | Value | Unit |
|--|-----------------|-------------|---------------------------|
| Collector-Base Voltage | V_{CBO} | -160 | V |
| Collector-Emitter Voltage | V_{CEO} | -150 | V |
| Emitter-Base Voltage | V_{EBO} | -5.0 | V |
| Collector Current - Continuous (Note 1) | I_C | -200 | mA |
| Power Dissipation (Note 1) | P_d | 200 | mW |
| Thermal Resistance, Junction to Ambient (Note 1) | $R_{\theta JA}$ | 625 | $^\circ\text{C}/\text{W}$ |
| Operating and Storage and Temperature Range | T_j, T_{STG} | -55 to +150 | $^\circ\text{C}$ |

- Note: 1. Device mounted on FR-4 PCB, 1 inch x 0.85 inch x 0.062 inch; pad layout as shown on Diodes Inc. suggested pad layout document AP02001, which can be found on our website at <http://www.diodes.com/datasheets/ap02001.pdf>.
2. No purposefully added lead.

Electrical Characteristics @ $T_A = 25^\circ\text{C}$ unless otherwise specified

| Characteristic | Symbol | Min | Max | Unit | Test Condition |
|--------------------------------------|---------------|----------------|---------------|---------------------|--|
| OFF CHARACTERISTICS (Note 3) | | | | | |
| Collector-Base Breakdown Voltage | $V_{(BR)CBO}$ | -160 | — | V | $I_C = -100\mu\text{A}, I_E = 0$ |
| Collector-Emitter Breakdown Voltage | $V_{(BR)CEO}$ | -150 | — | V | $I_C = -1.0\text{mA}, I_B = 0$ |
| Emitter-Base Breakdown Voltage | $V_{(BR)EBO}$ | -5.0 | — | V | $I_E = -10\mu\text{A}, I_C = 0$ |
| Collector Cutoff Current | I_{CBO} | — | -50 | nA μA | $V_{CB} = -120\text{V}, I_E = 0$ $V_{CB} = -120\text{V}, I_E = 0, T_A = 100^\circ\text{C}$ |
| Emitter Cutoff Current | I_{EBO} | — | -50 | nA | $V_{EB} = -3.0\text{V}, I_C = 0$ |
| ON CHARACTERISTICS (Note 3) | | | | | |
| DC Current Gain | h_{FE} | 50 60 50 | — 240 — | — | $I_C = -1.0\text{mA}, V_{CE} = -5.0\text{V}$ $I_C = -10\text{mA}, V_{CE} = -5.0\text{V}$ $I_C = -50\text{mA}, V_{CE} = -5.0\text{V}$ |
| Collector-Emitter Saturation Voltage | $V_{CE(SAT)}$ | — | -0.2 -0.5 | V | $I_C = -10\text{mA}, I_B = -1.0\text{mA}$ $I_C = -50\text{mA}, I_B = -5.0\text{mA}$ |
| Base-Emitter Saturation Voltage | $V_{BE(SAT)}$ | — | -1.0 | V | $I_C = -10\text{mA}, I_B = -1.0\text{mA}$ $I_C = -50\text{mA}, I_B = -5.0\text{mA}$ |
| SMALL SIGNAL CHARACTERISTICS | | | | | |
| Output Capacitance | C_{obo} | — | 6.0 | pF | $V_{CB} = -10\text{V}, f = 1.0\text{MHz}, I_E = 0$ |
| Small Signal Current Gain | h_{fe} | 40 | 200 | — | $V_{CE} = -10\text{V}, I_C = -1.0\text{mA}, f = 1.0\text{kHz}$ |
| Current Gain-Bandwidth Product | f_T | 100 | 300 | MHz | $V_{CE} = -10\text{V}, I_C = -10\text{mA}, f = 100\text{MHz}$ |
| Noise Figure | NF | — | 8.0 | dB | $V_{CE} = -5.0\text{V}, I_C = -200\mu\text{A}, R_S = 10\Omega, f = 1.0\text{kHz}$ |

Ordering Information (Note 4)

| Device | Packaging | Shipping |
|------------|-----------|------------------|
| MMST5401-7 | SOT-323 | 3000/Tape & Reel |

- Notes: 3. Short duration test pulse used to minimize self-heating effect.
 4. For Packaging Details, go to our website at <http://www.diodes.com/datasheets/ap02007.pdf>.
 5. For Lead Free/RoHS Compliant version part number, please add "-F" suffix to the part number above. Example: MMST5401-7-F.

Marking Information

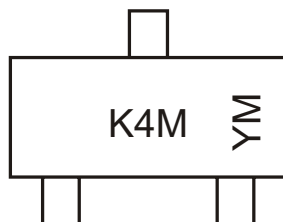

K4M = Product Type Marking Code
 YM = Date Code Marking
 Y = Year ex: N = 2002
 M = Month ex: 9 = September

Date Code Key

| | | | | | | | | | | | | |
|--------------|------|------|-------|------|------|------|------|------|------|------|------|------|
| Year | 1998 | 1999 | 2000 | 2001 | 2002 | 2003 | 2004 | 2005 | 2006 | 2007 | 2008 | 2009 |
| Code | J | K | L | M | N | P | R | S | T | U | V | W |
| Month | Jan | Feb | March | Apr | May | Jun | Jul | Aug | Sep | Oct | Nov | Dec |
| Code | 1 | 2 | 3 | 4 | 5 | 6 | 7 | 8 | 9 | O | N | D |

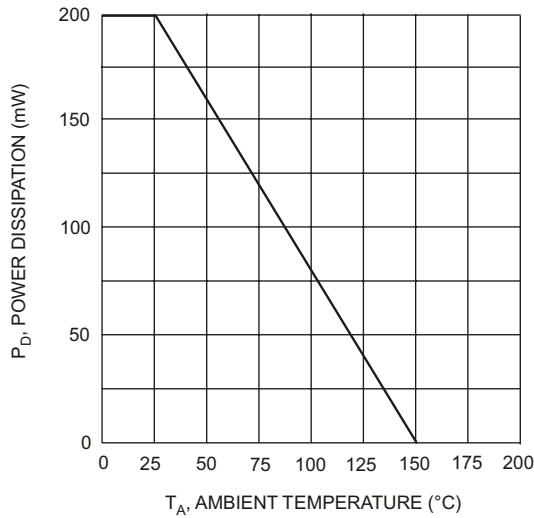

T_A , AMBIENT TEMPERATURE ($^{\circ}\text{C}$)
Fig. 1, Max Power Dissipation vs Ambient Temperature

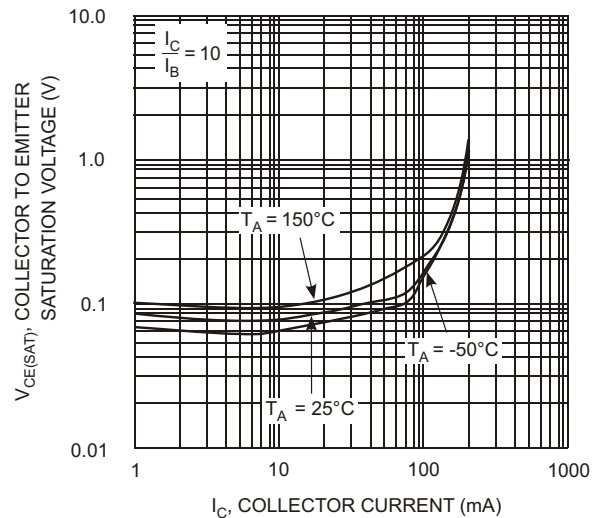

I_C , COLLECTOR CURRENT (mA)
Fig. 2, Collector Emitter Saturation Voltage vs. Collector Current

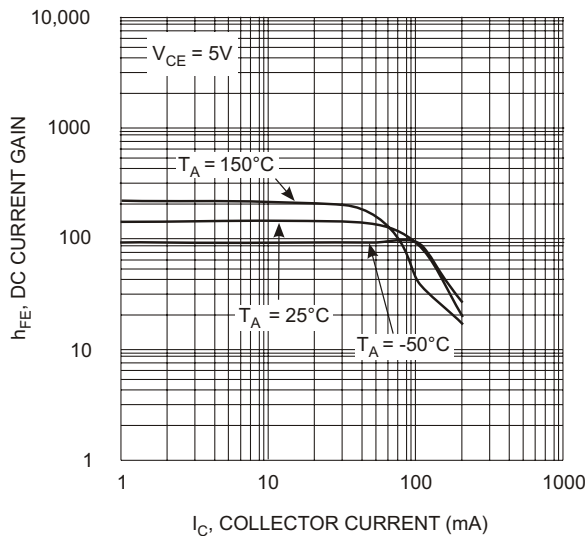

I_C , COLLECTOR CURRENT (mA)
Fig. 3, DC Current Gain vs. Collector Current

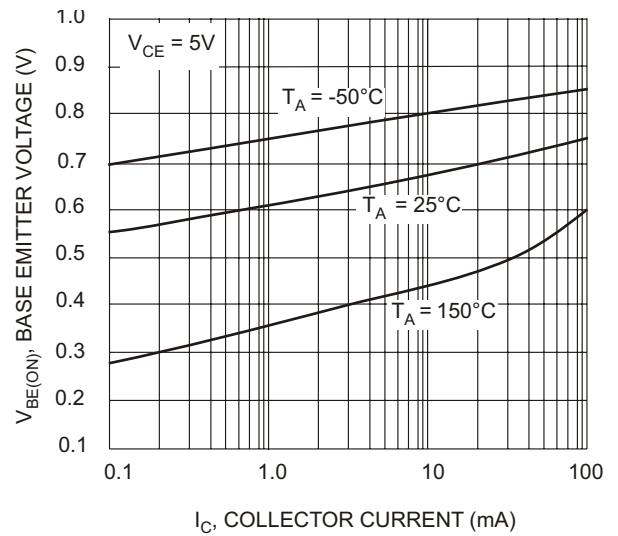

I_C , COLLECTOR CURRENT (mA)
Fig. 4, Base Emitter Voltage vs. Collector Current

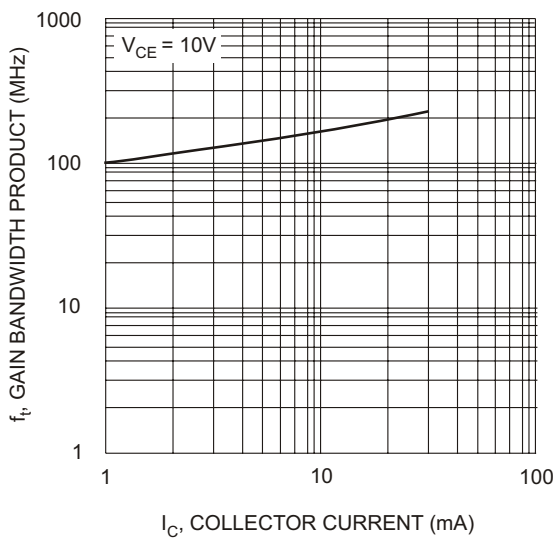

I_C , COLLECTOR CURRENT (mA)
Fig. 5, Gain Bandwidth Product vs Collector Current