

NO.	MASSE / DIMENSION
A	46.6
B	1 7/16-18UNEF-2A
C	66
D	27.5
E	32
F	9.4

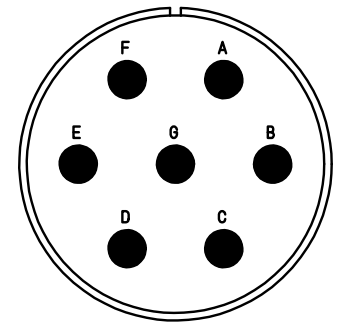
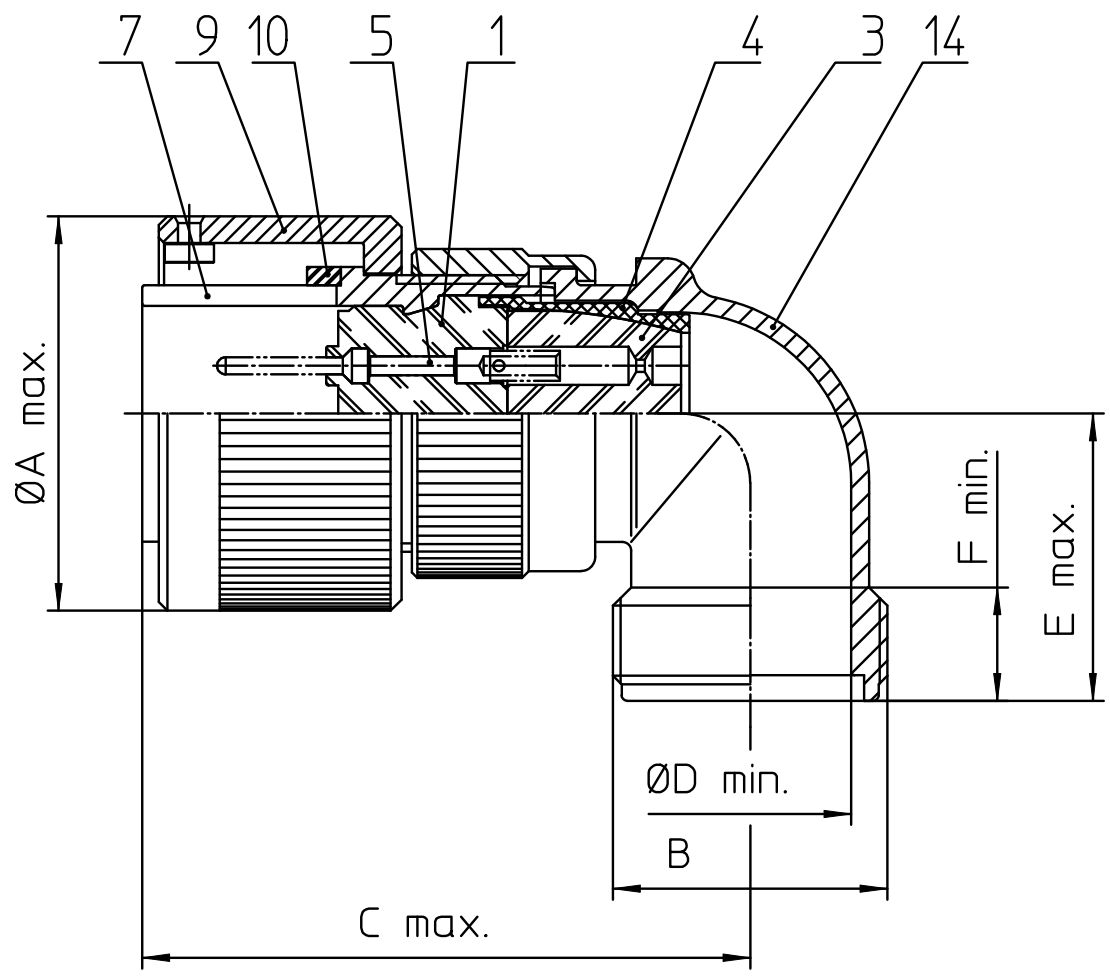

NO.	BESCHREIBUNG / DESCRIPTION
1	ISOLIERKÖRPER STIFT / INSULATOR PIN
3	DICHTKÖRPER / GROMMET
4	ENDRING / ENDRING
5	KONTAKTSTIFT/ CONTACT PIN
7	ZYLINDERGHÄUSE / BARREL
9	ÜBERWURFMUTTER / COUPLING NUT
10	DICHTRING FRONT / FRONT SEALING RING
11	SCHIRMKRANZ/SHIELDING BRAID
14	F-ENDGEHÄUSE / F-ENDBELL

Note: Due to an automatic nomenclature system, numbers generated may not be sequential.
 Specification and Dimensions subject to change
 Drawings illustrate normal insulator positioning

Material Specification:	
Shell Material:	Aluminium alloy
Shell Plating:	Olive drab chromate over cadmium (conductive)
Insulator Material:	CR-Elastomere
Contact Material:	Copper alloy
Contact Plating:	Hard silver

all dimensions are in mm
 Dimensions without tolerance indications are general tolerances in acc. with DIN7168m

drawing for
CUSTOMER

description **CA3108F24-10P-B-15**
Plug, 90° shielded
 Shielded with endbell for shielded braids & heat shrinkable boots
 AWG Crimp / Pin / Layout: 24-10