

## DETAILS

<b>Product Number</b>	FCN13698_ANGELA-M
<b>Family</b>	ANGELA
<b>Type</b>	RefPack
<b>Color</b>	metal
<b>Diameter</b>	119,5 mm
<b>Height</b>	79,31 mm
<b>Style</b>	round
<b>Optic Material</b>	
<b>Holder Material</b>	
<b>Fastening</b>	
<b>Status</b>	production ready
<b>ROHS Compliant</b>	Yes
<b>Date Updated</b>	3/11/2016



## OPTICAL PROPERTIES

LED	Viewing Angle	Light Beam	Efficiency	cd/lm	Connector
VERO29	29 deg	Medium	85 %	1.900	LEDiL: LEDiL
CLL04x/CLU04x	21 deg	Medium	84 %	2.700	Bender Wirth: 431 Typ L3
CLU730/731	15 deg	Medium	84 %	3.800	Bender Wirth: 471 Typ L3
LUXEON CoB 1211	19 deg	Medium	85 %	3.000	Bender Wirth: 431 Typ L3
Soleriq S19	17 deg	Medium	83 %	3.400	Bender Wirth: 462 Typ L3
MJT COB LES 22	22 deg	Medium	82 %	2.500	Bender Wirth: 431 Typ L3

H G F E D C B A

4

3

2

1

4

3

2

1

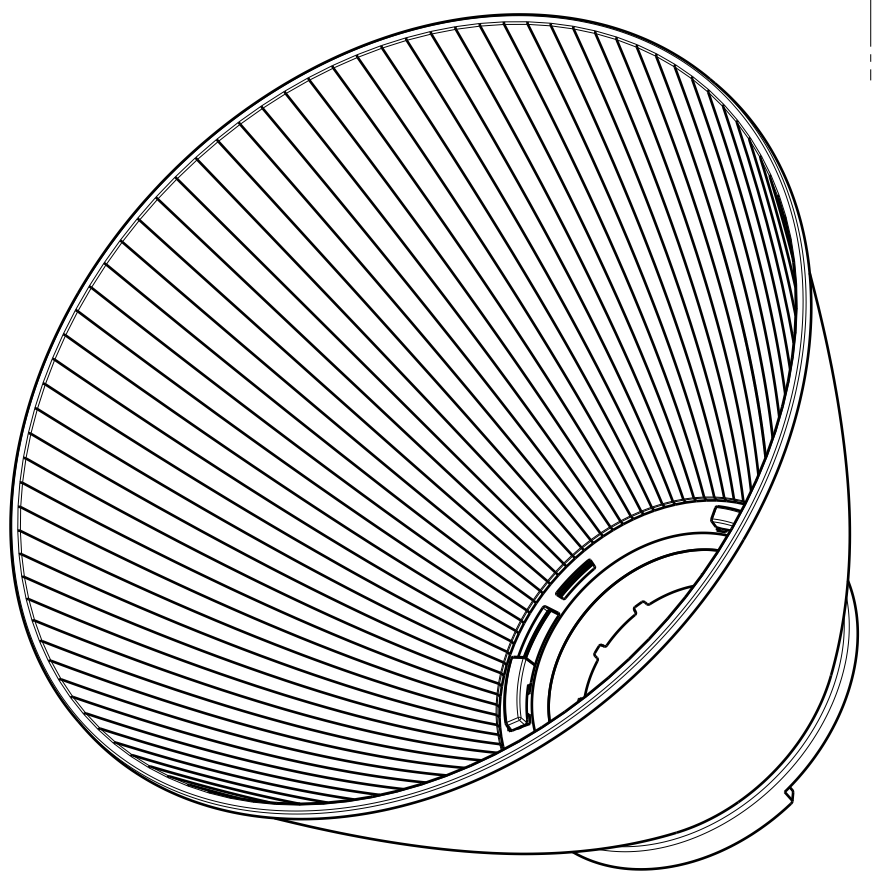
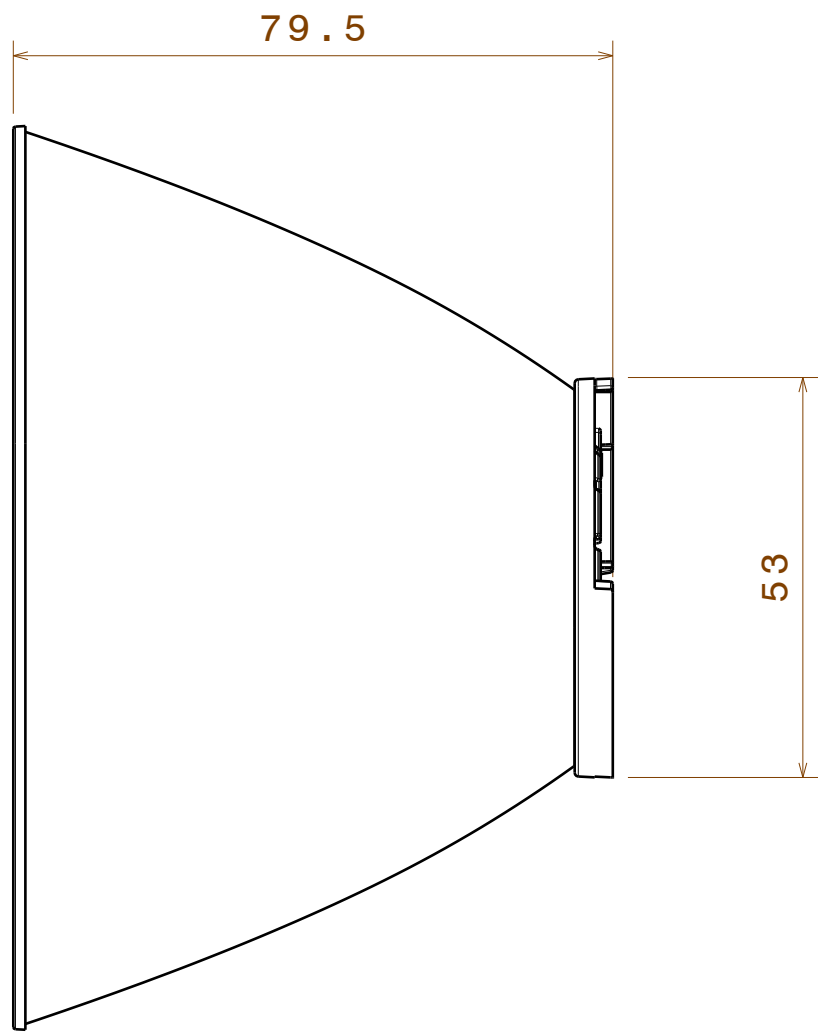
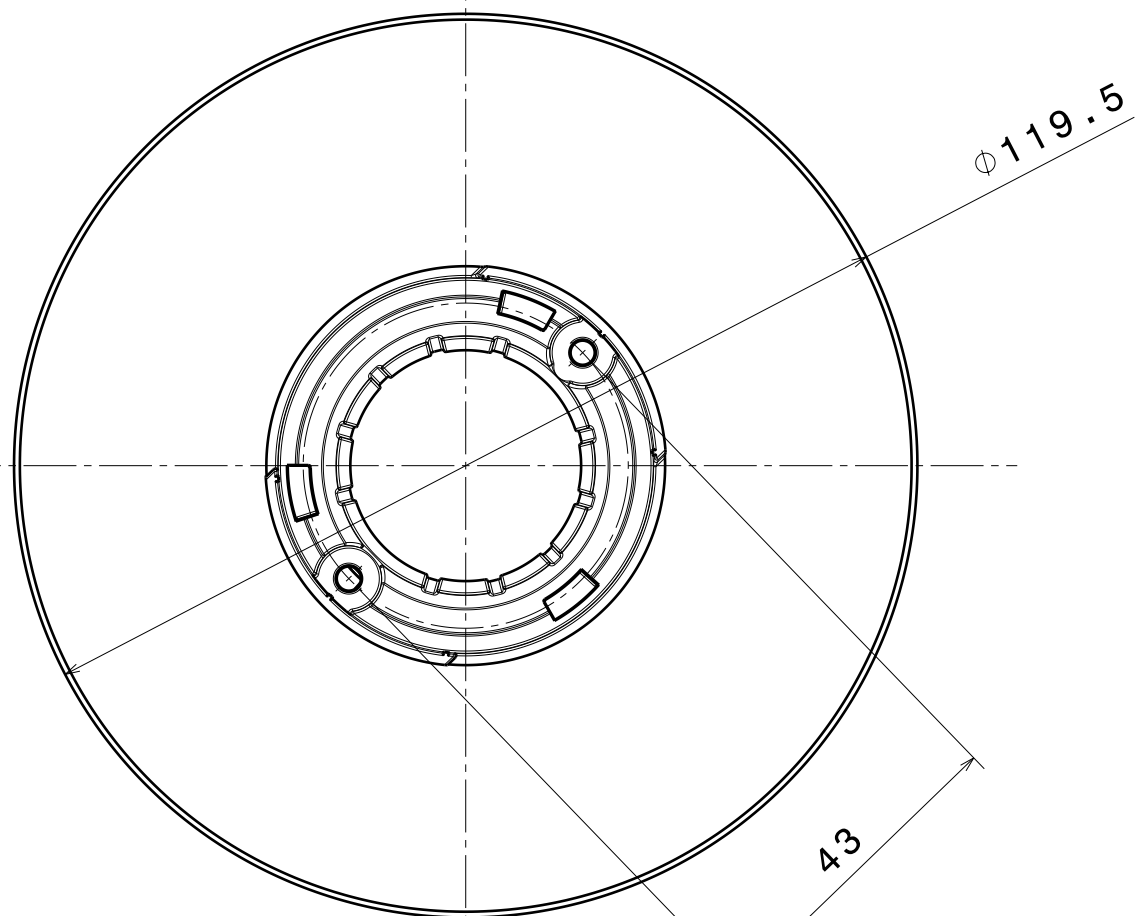

Tolerances if not otherwise shown  
 According to DIN ISO 2768-1  
 Linear measures:  
 Up to 30mm class M, otherwise class C.  
 According to DIN ISO 2768-2  
 Form and position: class L

**LEDiL** Ledil Oy  
 Salorankatu 10  
 FIN 24240 SALO  
 Finland

THIRD ANGLE PROJECTION:

DRAWING TITLE  
**DATA SHEET ANGELA - VERO SOCKET 29**

This drawing is the property  
 of LEDiL Oy. It may not be  
 reproduced, copied or  
 communicated without a written  
 agreement with LEDiL Oy."

SIZE	PART NUMBER
A3	-

SCALE	1:1	WEIGHT	-	SHEET	1/1
-------	-----	--------	---	-------	-----

H G B A

Luminaire: LEDiL Oy FCN13698\_ANGELA-M\_(VERO29) Eff.83.2%  
Lamps: 1 x VERO29\_(BXRC-50C10K0-L-04)\_1388.09lm@250mA\_CCT=1399K\_P=8.60286W\_I=249.8mA

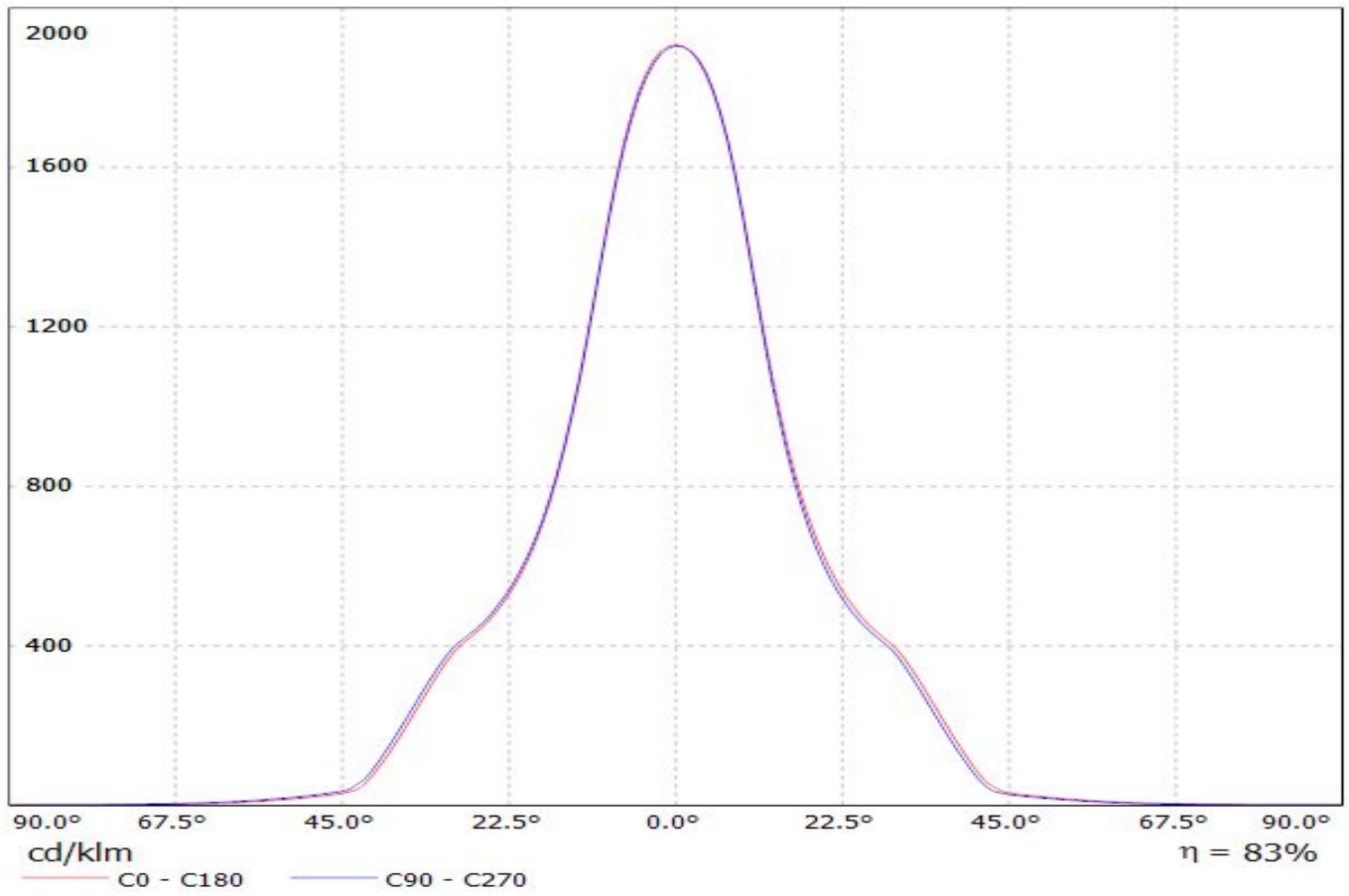

Luminaire: Ledil FCN13698\_ANGELA-M (CLU044)\_ (431\_Typ\_L3)

Lamps: 1 x Citizen\_CLU044\_(CLU044-1212B8-303M1A2)\_1272.54lm@250mA\_P=8.16W\_I=0.25A

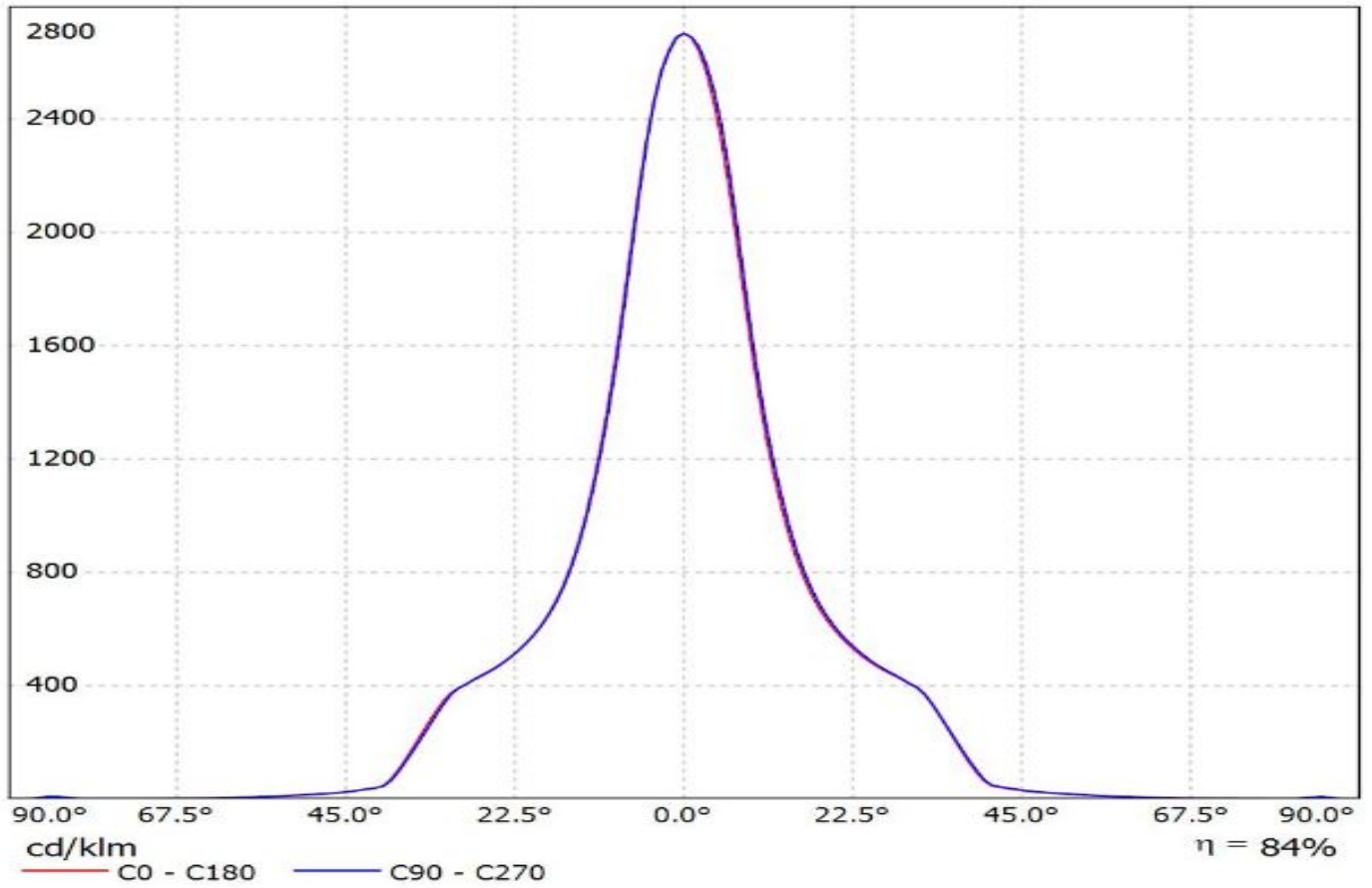

Luminaire: LEDiL Oy FCN13698\_ANGELA-M (CLU730)\_(471\_Typ\_L3)

Lamps: 1 x Citizen\_CLU730\_(CLU730-1210B8-273M2G1)\_(C13584\_CLAMP-VERO29)\_(471\_Typ\_L3)\_1166.91lm@250mA\_P=8.09751W\_I=0.2499A

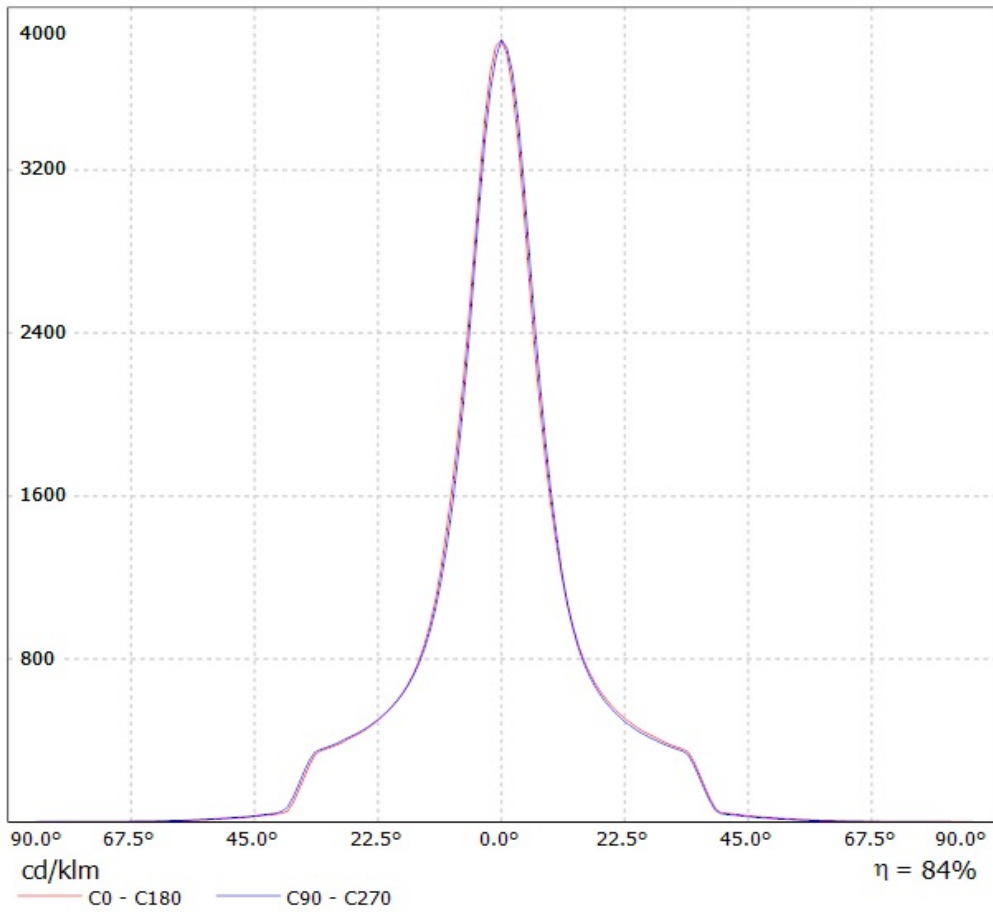

# LEDiL Oy FCN13698\_ANGELA-M\_(CoB\_1211)\_(431\_Typ\_L3) / LDC (Linear)

Luminaire: LEDiL Oy FCN13698\_ANGELA-M\_(CoB\_1211)\_(431\_Typ\_L3)

Lamps: 1 x [LAMP] Luxeon\_CoB\_1211\_(LHC1-5780-1211)\_(431\_Typ\_L3)\_(C13867\_LENA-STD-BASE-VERO29)\_897.994lm@250mA\_P=8W\_I=0.25A

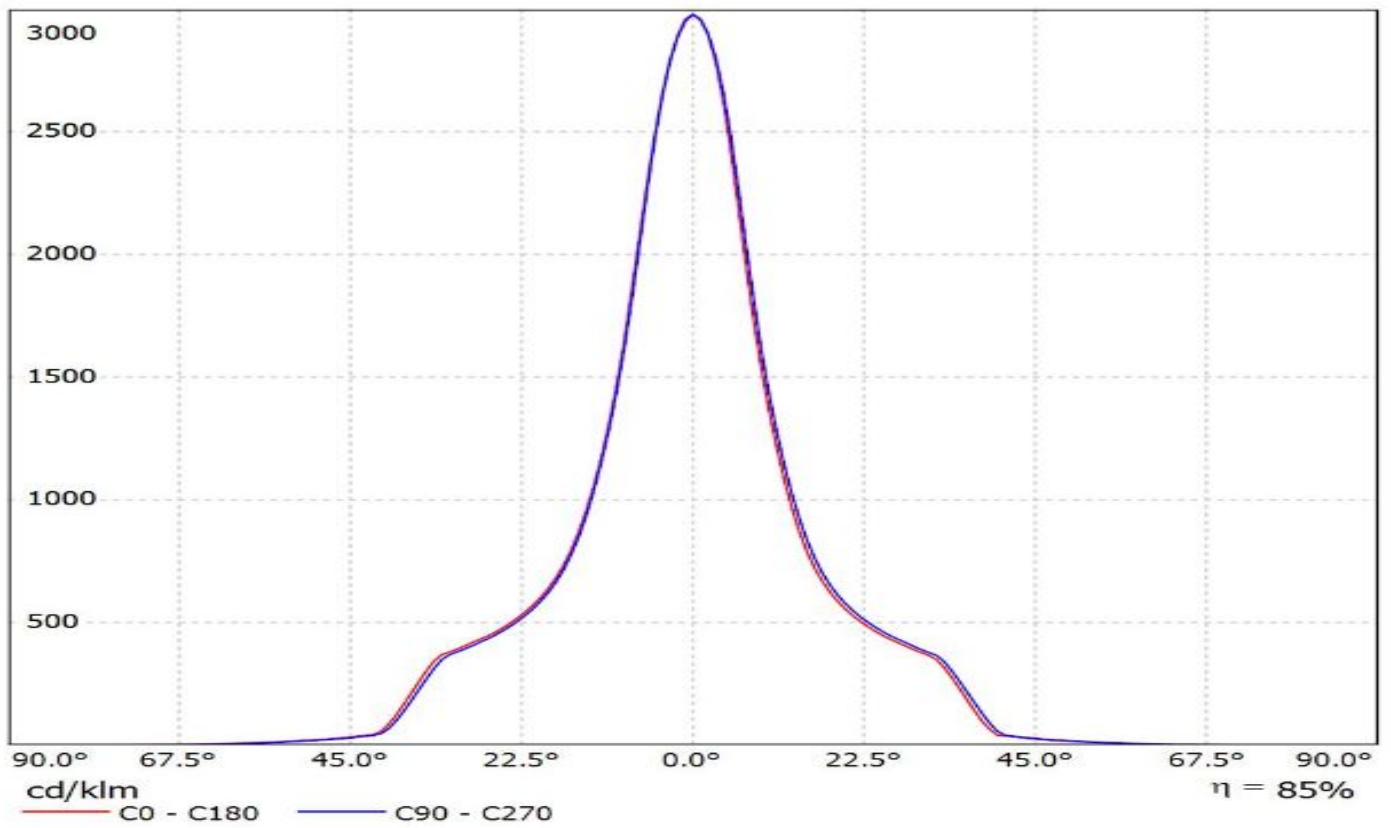

Luminaire: LEDiL Oy FCN13698\_ANGELA-M (Soleriq\_S19)\_462\_Typ\_L3)

Lamps: 1 x Osram\_Soleriq\_S19\_(GW\_KAHJB1.EM)\_1497.37lm@250mA\_P=11.1223W\_I=0.2532A

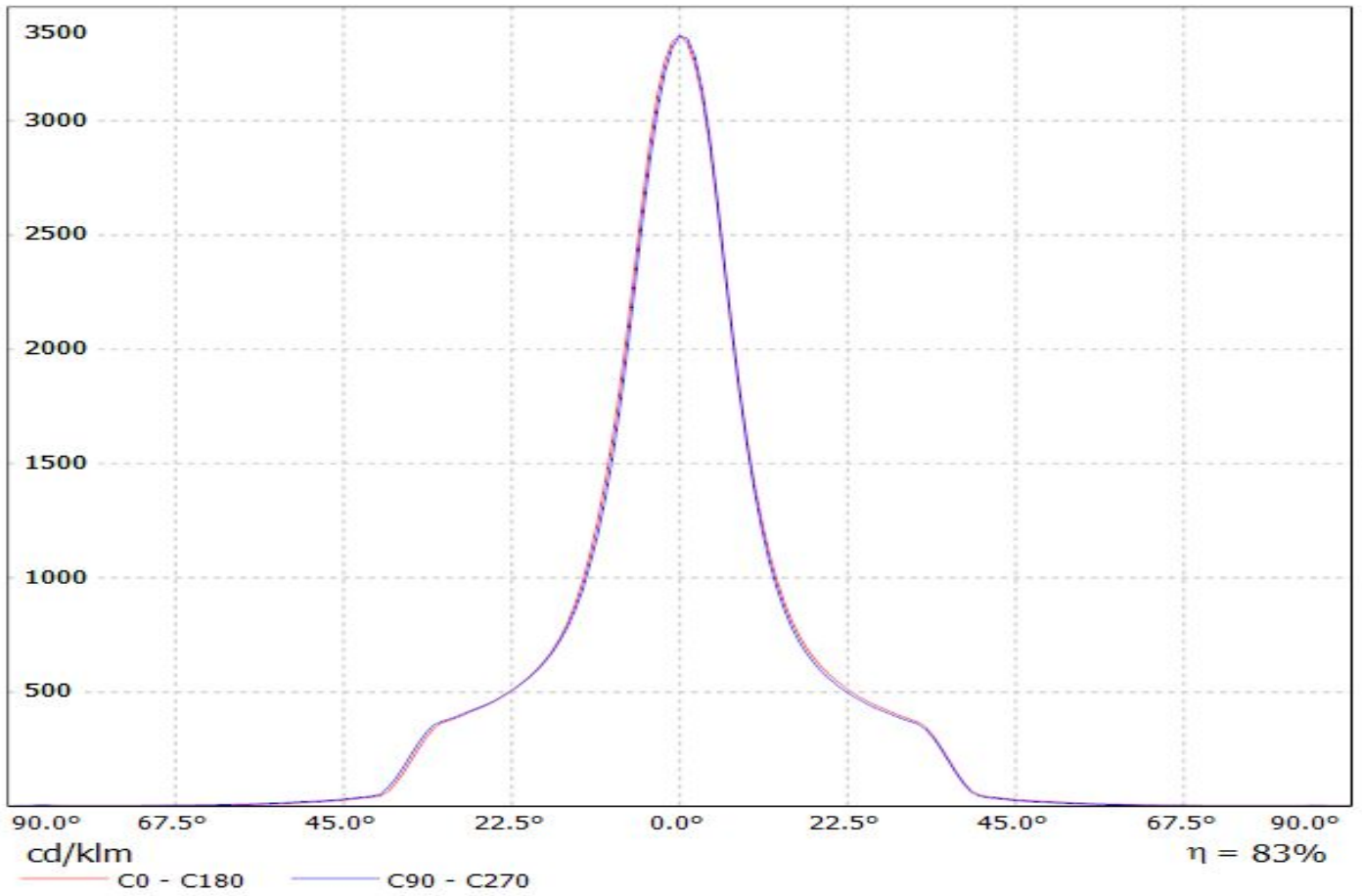



Luminaire: Ledil FCN13698\_ANGELA-M\_(MJT\_80W\_Les22)\_+431TypL3

Lamps: 1 x Seoul\_MJT\_80W\_Les22mm\_(SAWx22AAA)\_+\_VERO29\_+\_431TypL3\_2407.73lm@250mA\_P=13.2662W\_I=0.25A

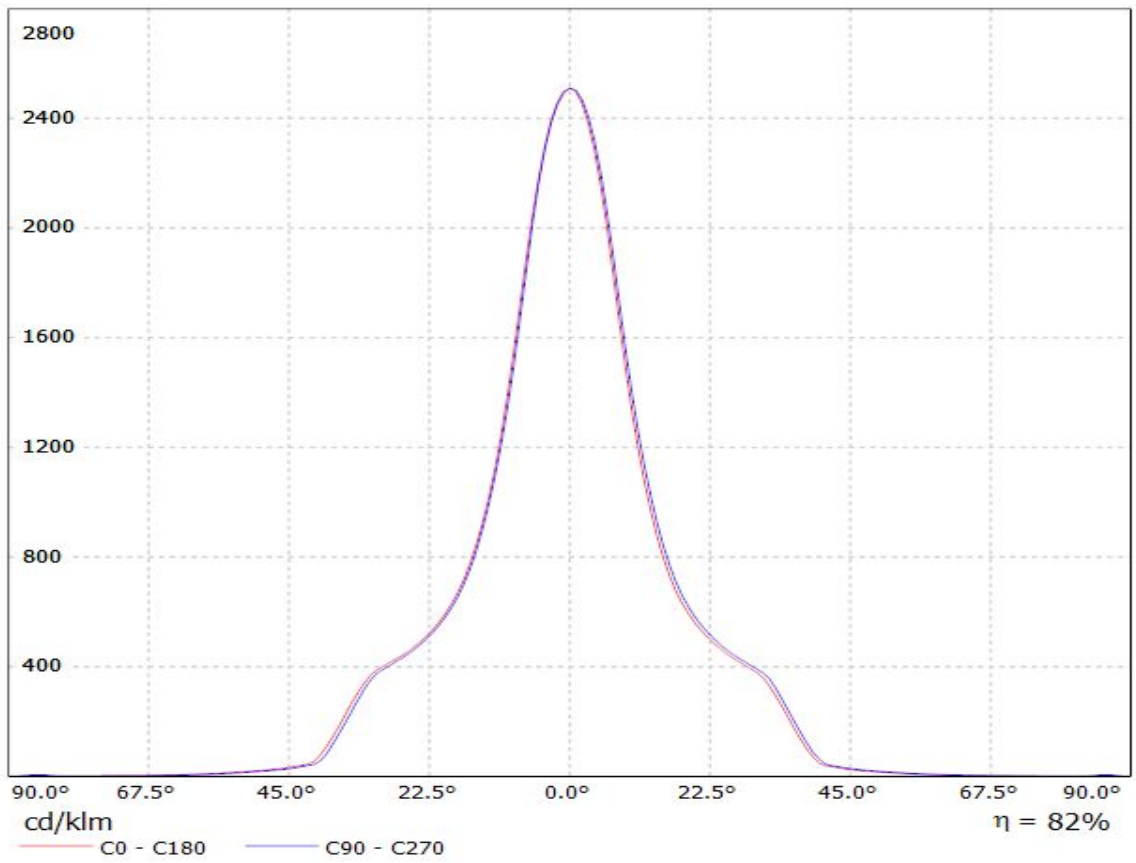



Luminaire: LEDiL Oy FCN13698\_ANGELA-M\_(VERO29) Eff.83.2%

Lamps: 1 x VERO29\_(BXRC-50C10K0-L-04)\_1388.09lm@250mA\_CCT=1399K\_P=8.60286W\_I=249.8mA

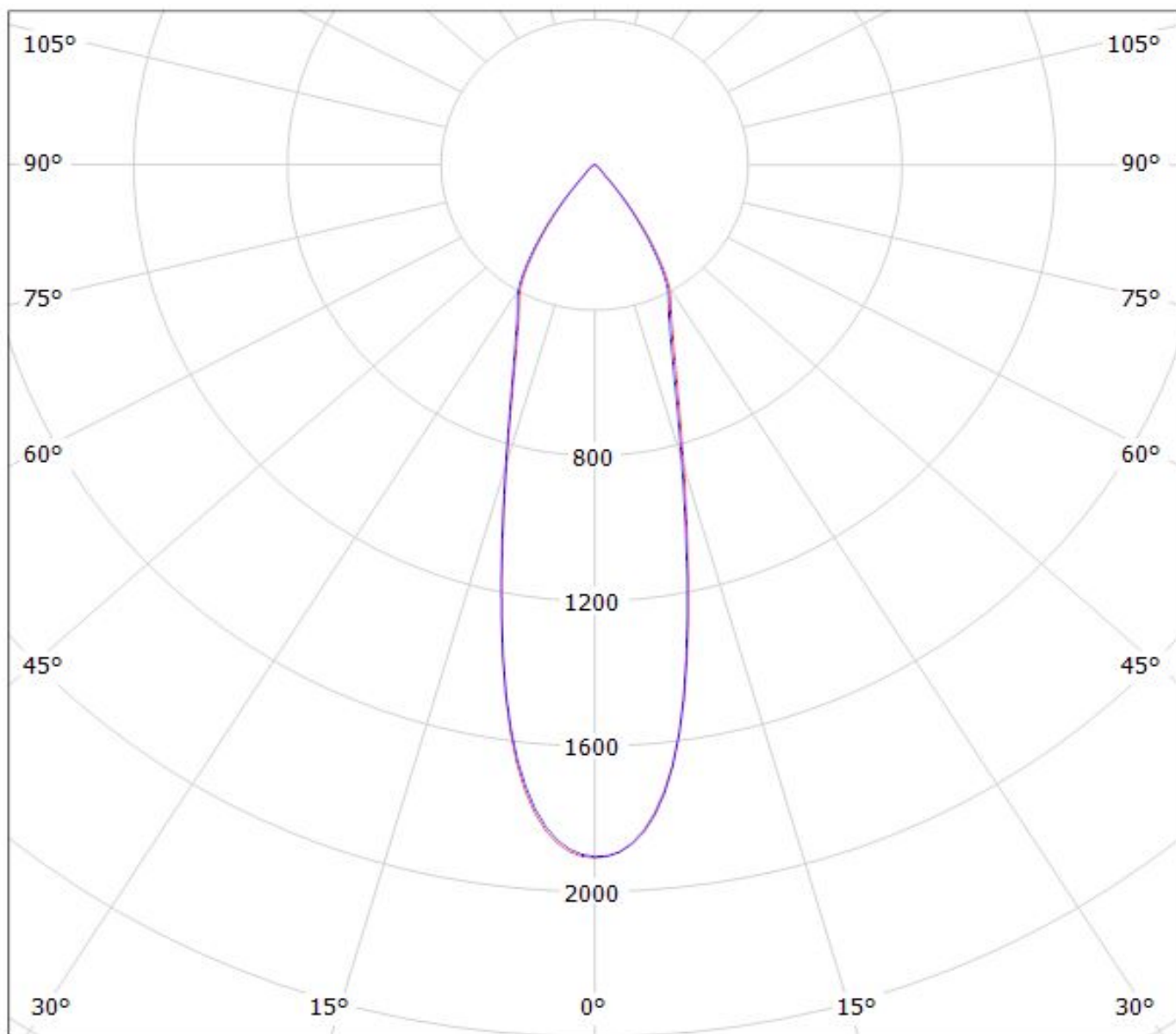

cd/klm

— C0 - C180

— C90 - C270

$\eta = 83\%$

Luminaire: Ledil FCN13698\_ANGELA-M\_(CLU044)\_(431\_Typ\_L3)

Lamps: 1 x Citizen\_CLU044\_(CLU044-1212B8-303M1A2)\_1272.54lm@250mA\_P=8.16W\_I=0.25A

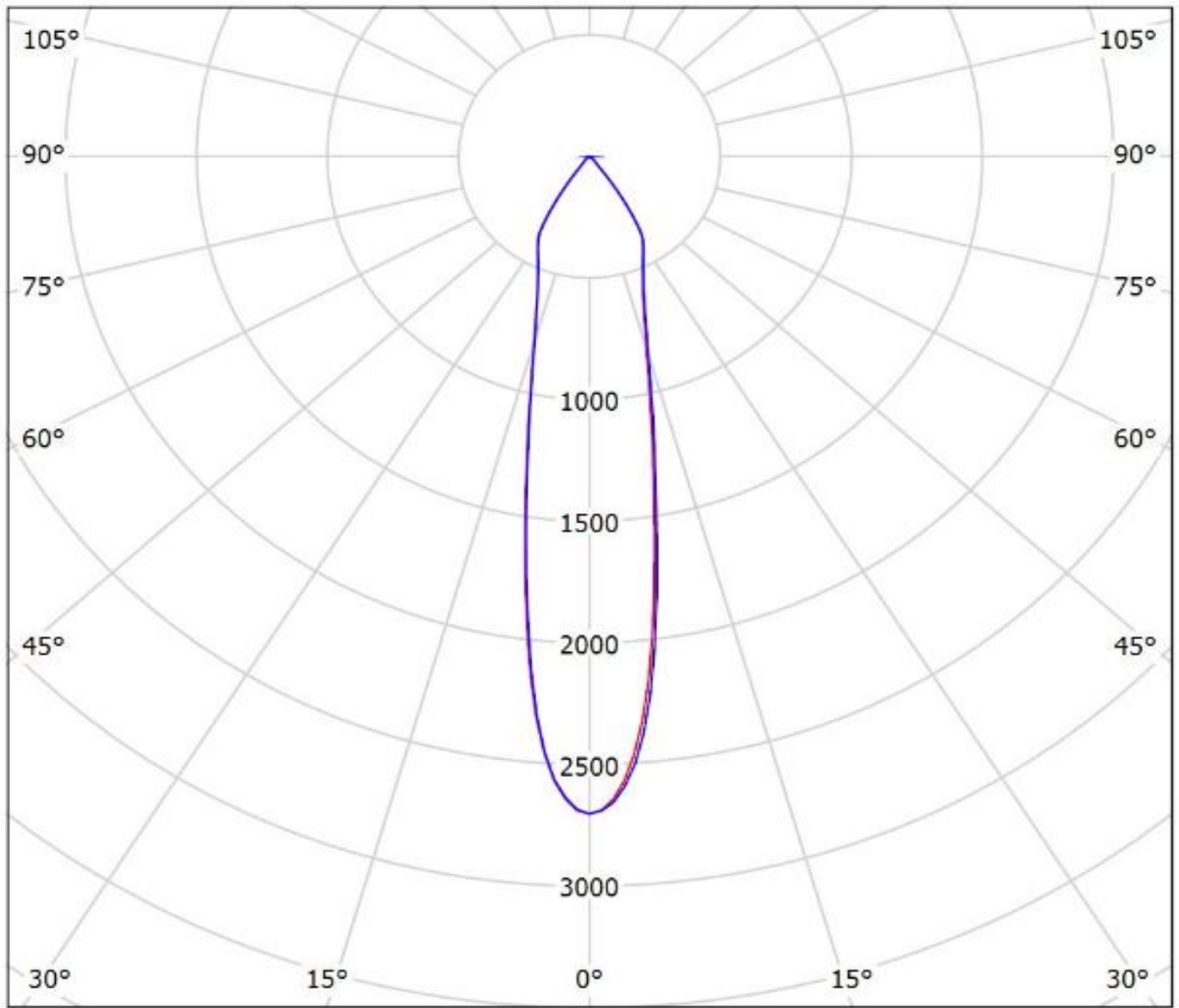

cd/klm

— C0 - C180 — C90 - C270

$\eta = 84\%$

Luminaire: LEDiL Oy FCN13698\_ANGELA-M\_(CLU730)\_ (471\_Typ\_L3)

Lamps: 1 x Citizen\_CLU730\_(CLU730-1210B8-273M2G1)\_ (C13584\_CLAMP-VERO29)\_ (471\_Typ\_L3)\_ 1166.91lm@250mA\_P=8.09751W\_I=0.2499A

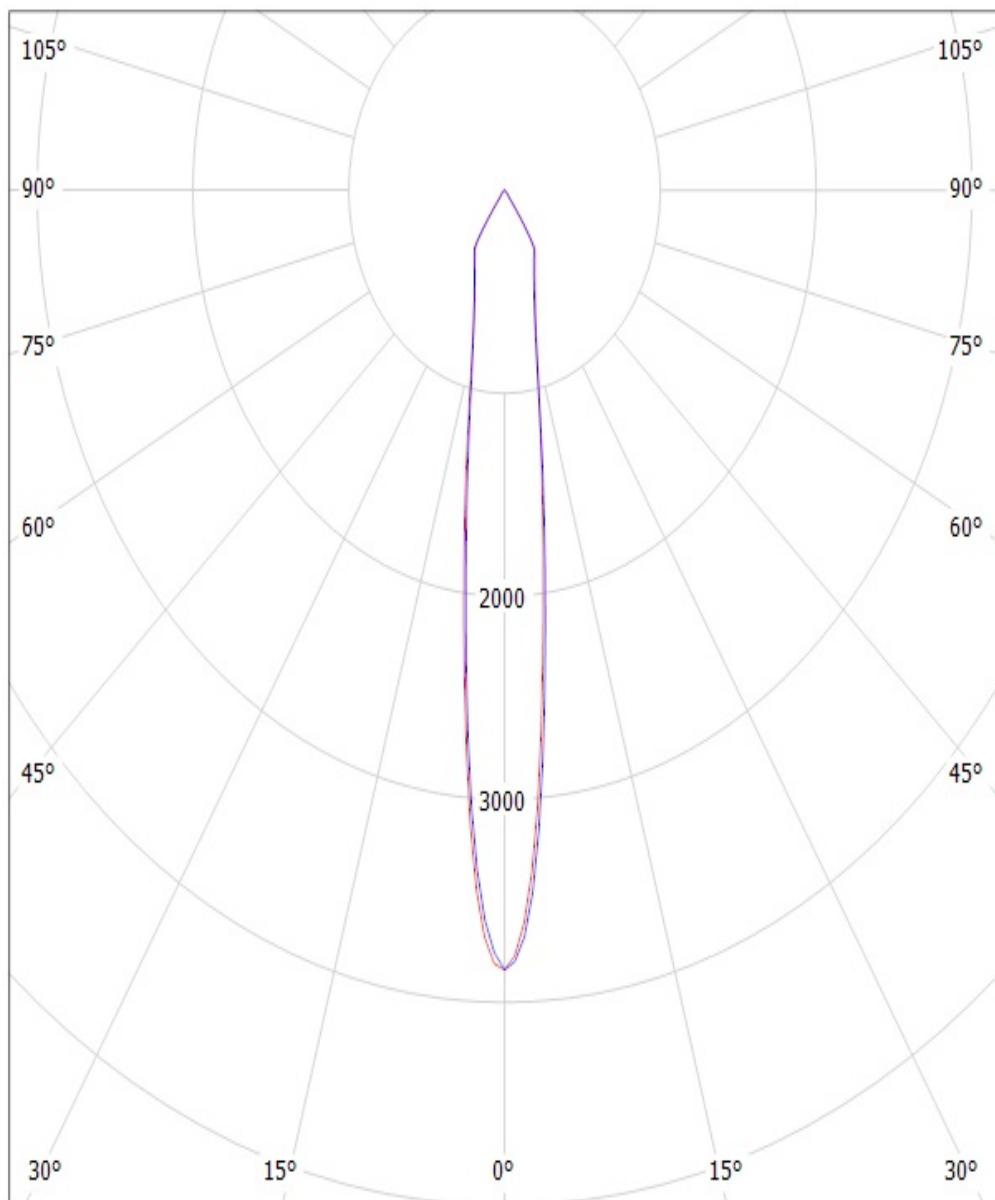

cd/klm

$\eta = 84\%$

— C0 - C180

— C90 - C270

# LEDiL Oy FCN13698\_ANGELA-M\_(CoB\_1211)\_(431\_Typ\_L3) / LDC (Polar)

Luminaire: LEDiL Oy FCN13698\_ANGELA-M\_(CoB\_1211)\_(431\_Typ\_L3)

Lamps: 1 x [LAMP] Luxeon\_CoB\_1211\_(LHC1-5780-1211)\_(431\_Typ\_L3)\_(C13867\_LENA-STD-BASE-VERO29)\_897.994lm@250mA\_P=8W\_I=0.25A

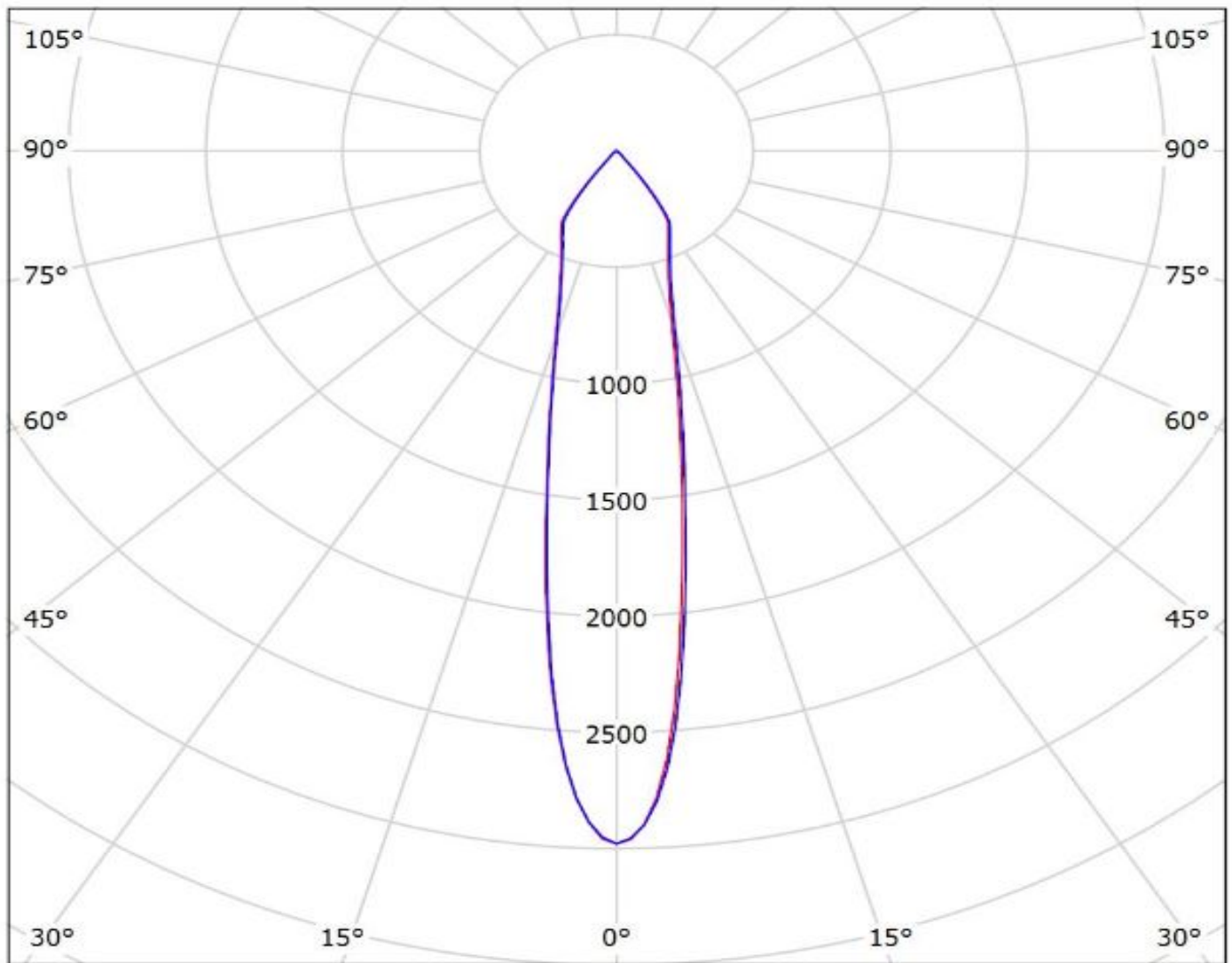

cd/klm

— C0 - C180

— C90 - C270

$\eta = 85\%$

Luminaire: LEDiL Oy FCN13698\_ANGELA-M\_(Soleriq\_S19)\_462\_Typ\_L3)

Lamps: 1 x Osram\_Soleriq\_S19\_(GW\_KAHJB1.EM)\_1497.37lm@250mA\_P=11.1223W\_I=0.2532A

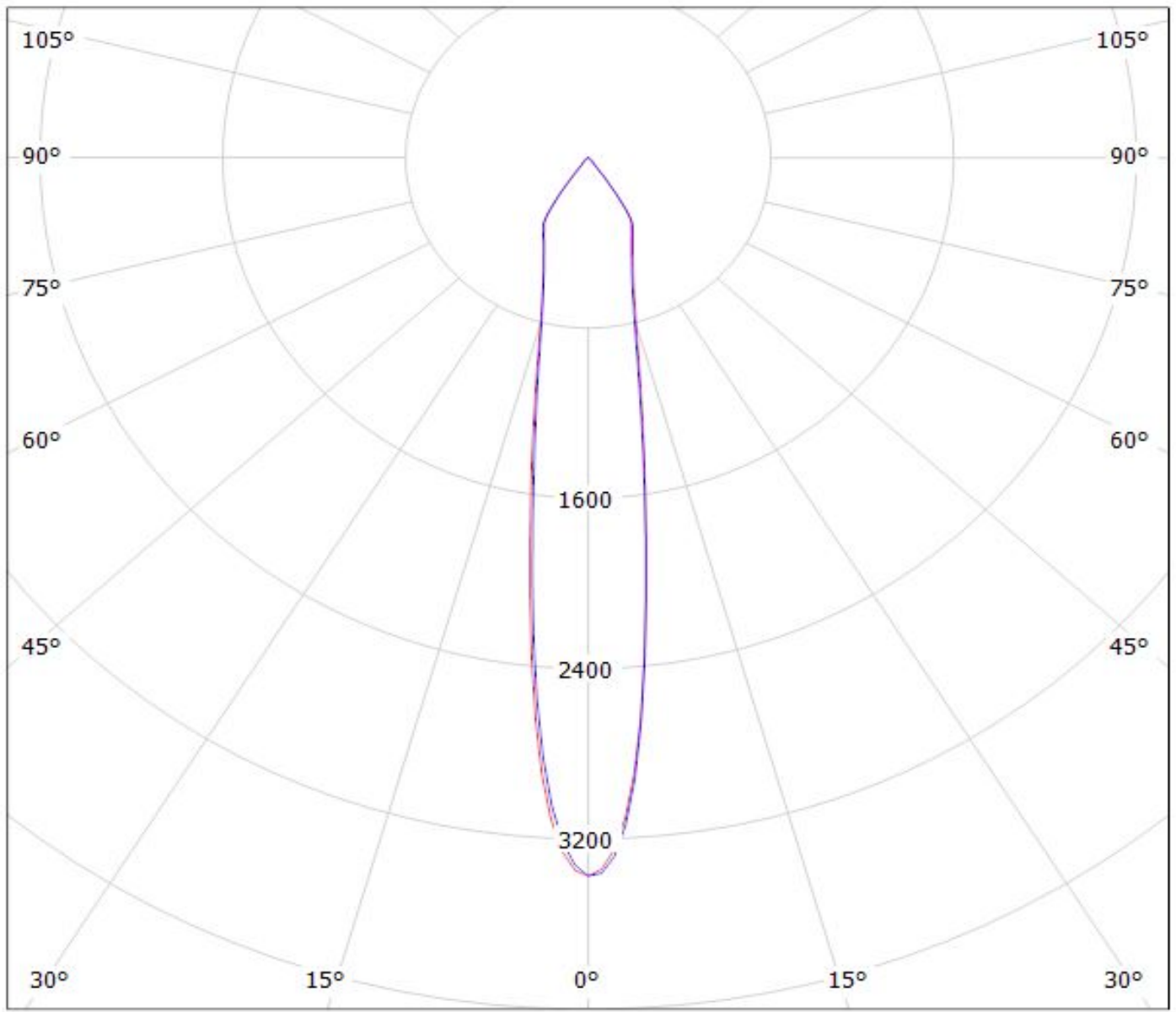

cd/klm

— C0 - C180    — C90 - C270

$\eta = 83\%$

Luminaire: Ledil FCN13698\_ANGELA-M\_(MJT\_80W\_Les22)\_+431TypL3

Lamps: 1 x Seoul\_MJT\_80W\_Les22mm\_(SAWx22AAA)\_+\_VERO29\_+\_431TypL3\_2407.73lm@250mA\_P=13.2662W\_I=0.25A

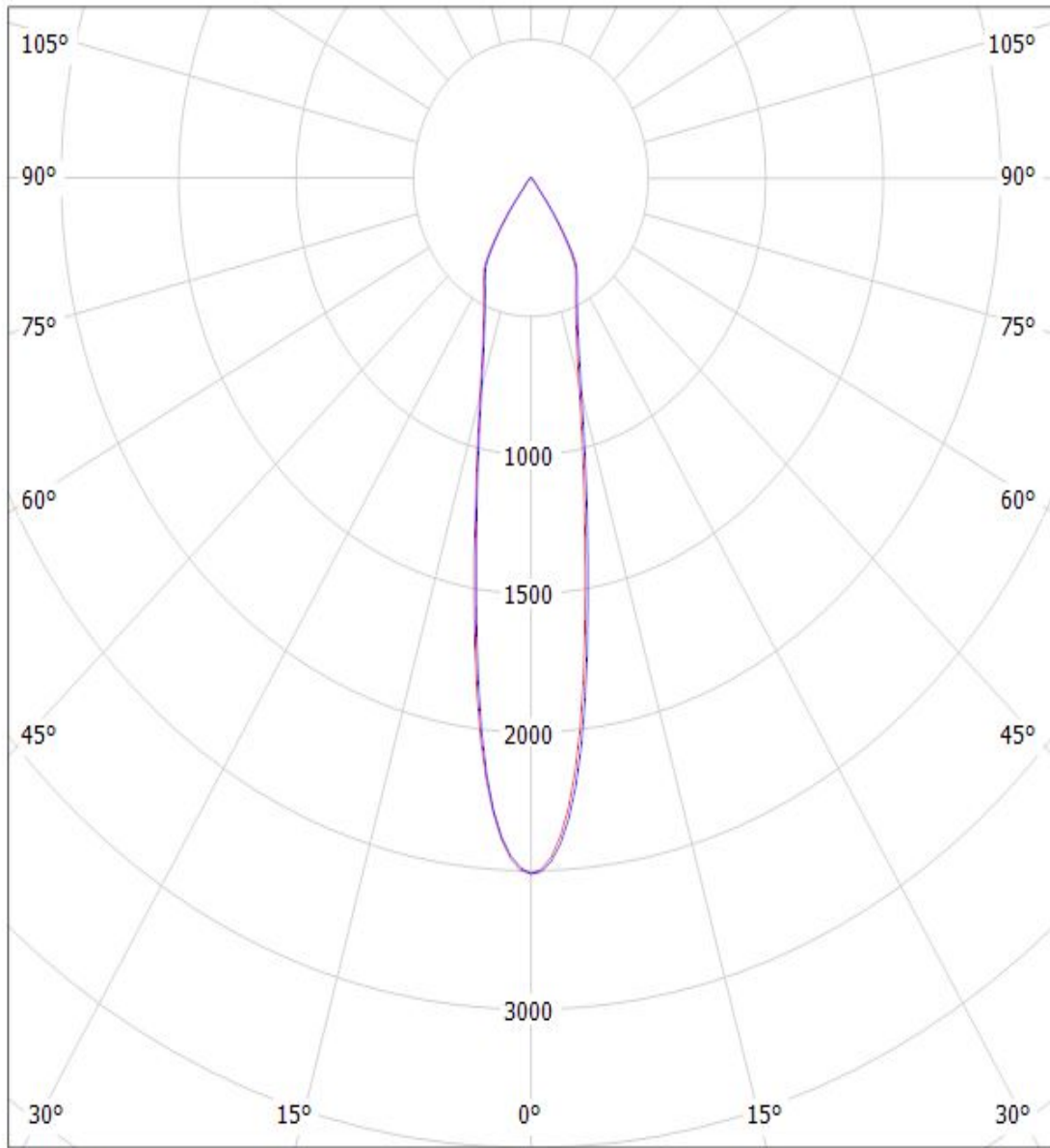

cd/klm

— C0 - C180

— C90 - C270

$\eta = 82\%$

**NOTE: The typical divergence will be changed by different color, chip size and chip position tolerance. The typical total divergence is the full angle measured where the luminous intensity is half of the peak value.**

### **GENERAL INFORMATION**

- Product series especially designed & optimized for series of LEDs.
- Special care taken to make light distribution as uniform as possible.

Note! Due to use of high power COB's with this product, special attention to proper thermal design is highly recommended. LEDiL has no liability for direct, indirect or consecutive damages arising from the LEDiL products being used outside of the recommended temperature range.