

* = Mass durch Formkonizität nach unten verringert.
Freimass – Toleranz nach GTA 13/5 DIN 1688

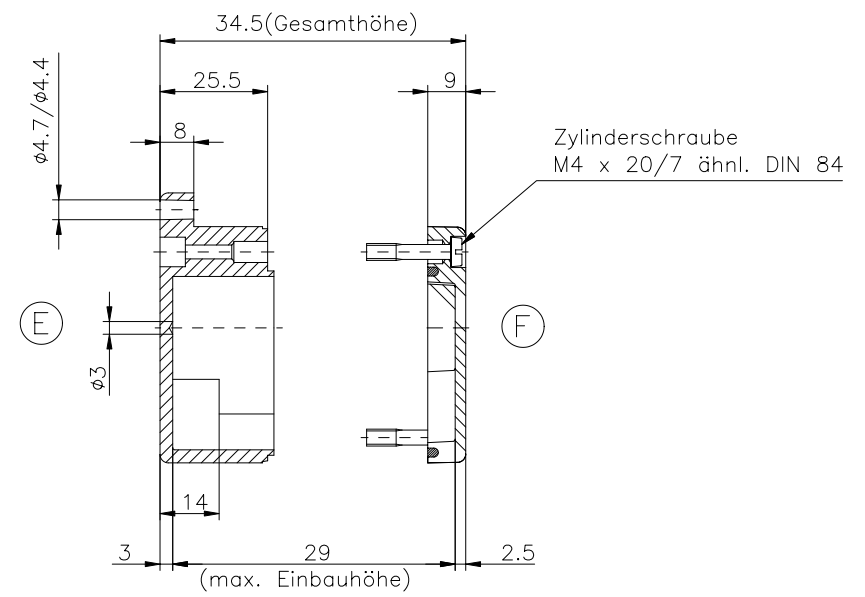
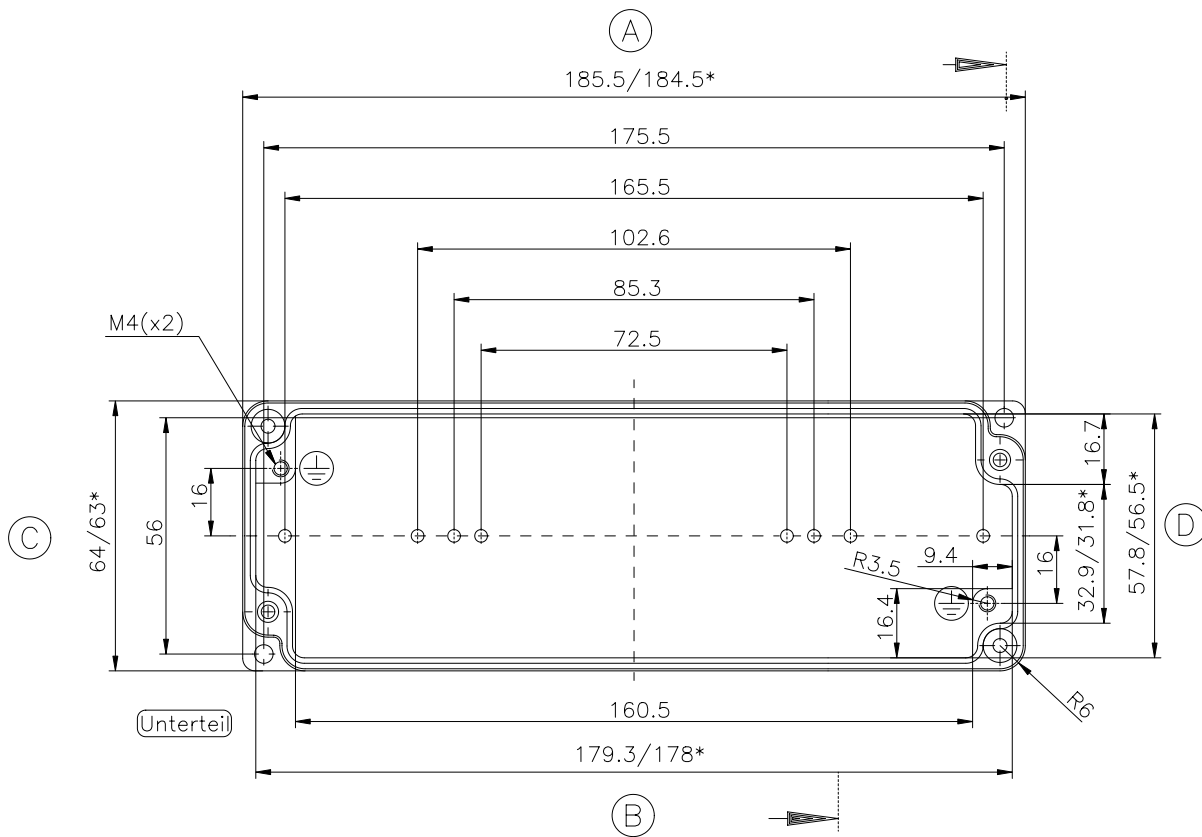

Aluminium-Standardgehäuse
Best.Nr. 01.061900