

Alle Rechte vorbehalten/ All rights reserved

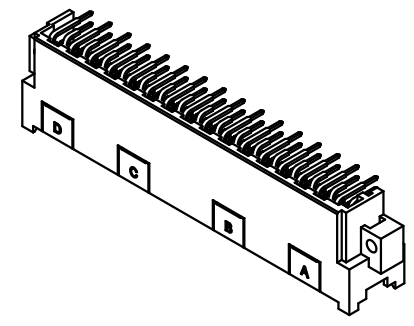
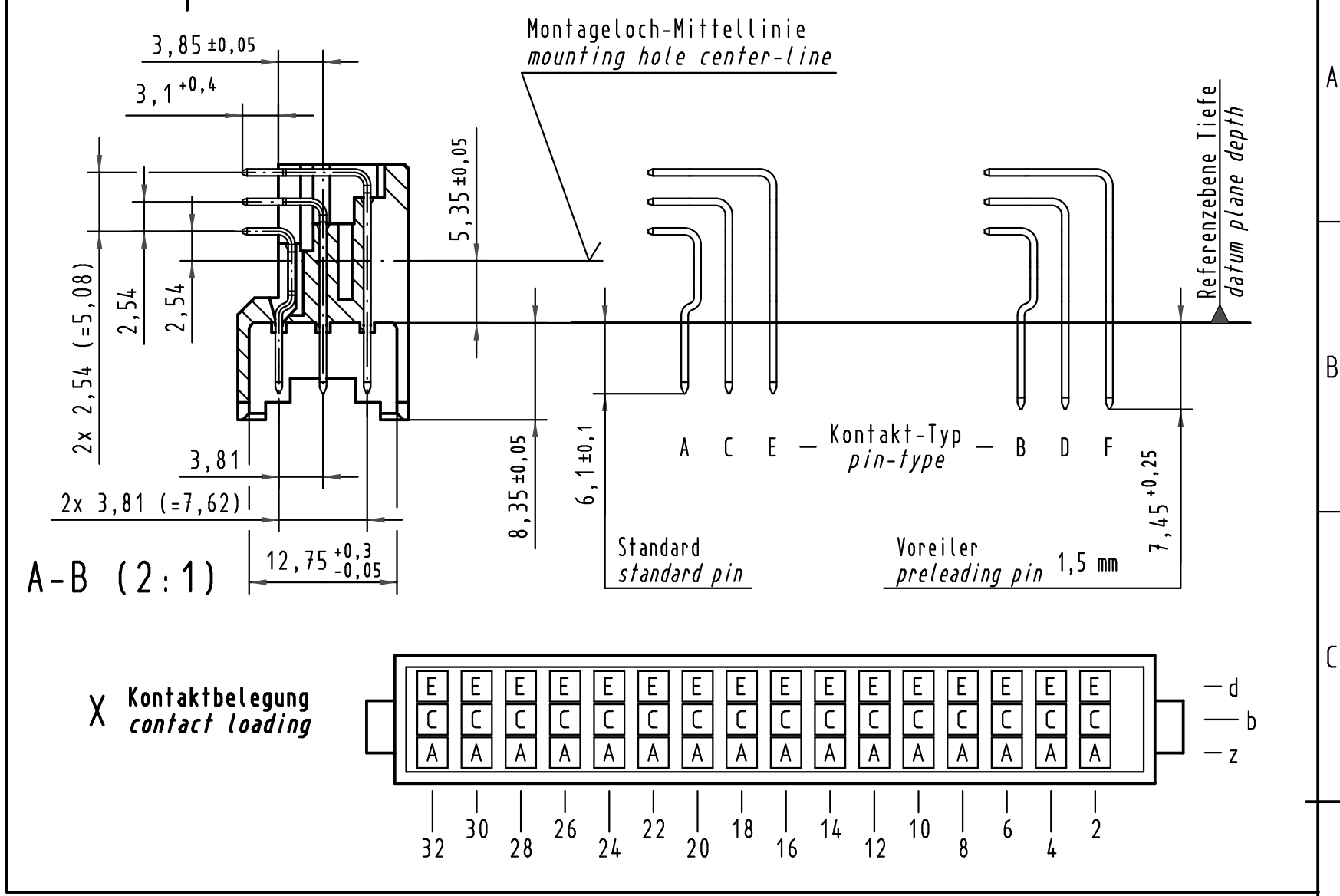
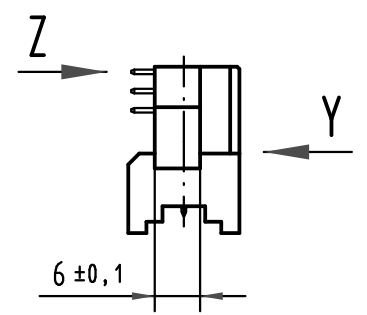
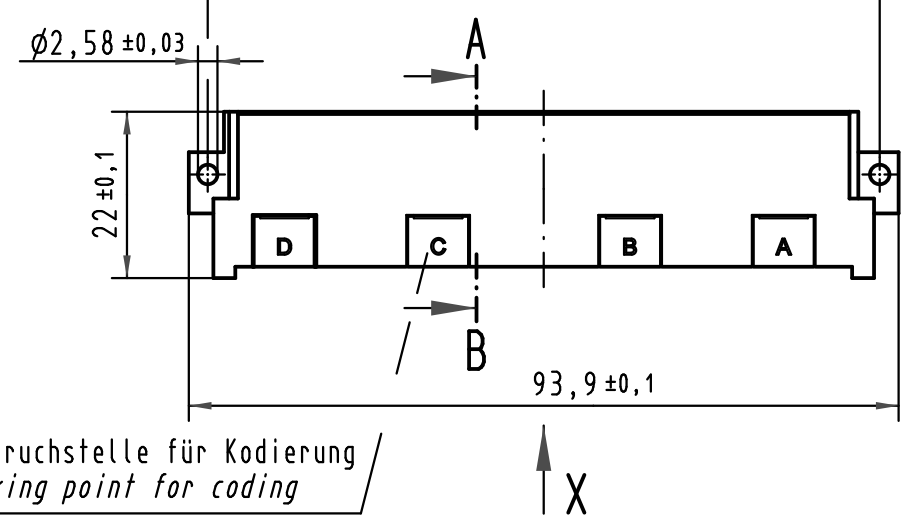
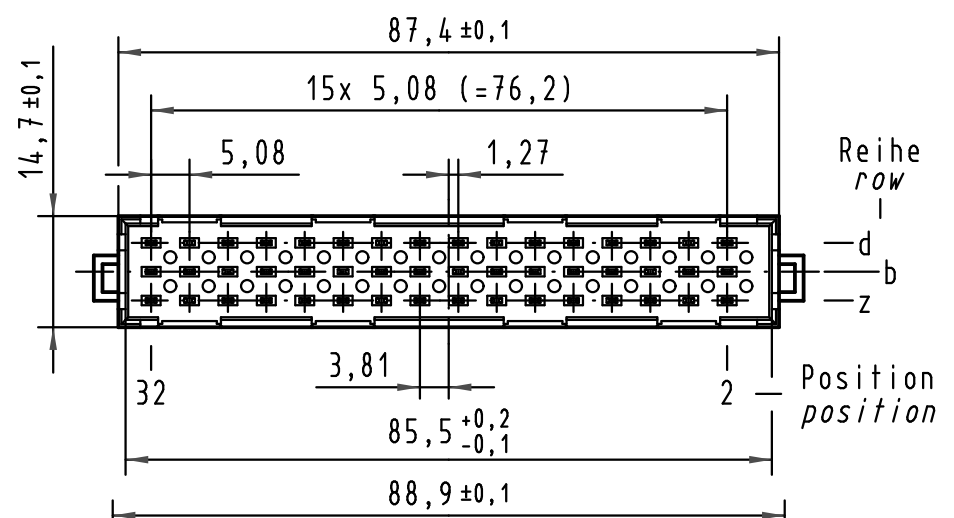
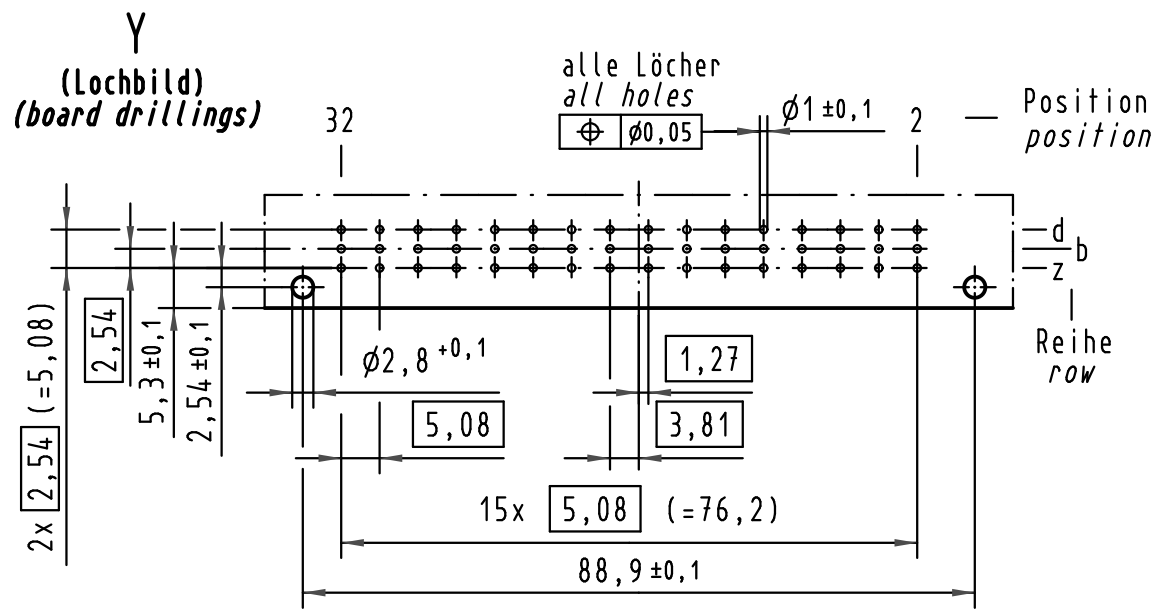

09 06 148 6901 222	2	Au flash over PdNi over Ni
09 06 148 2901 222	1	Au flash over PdNi over Ni
Bestell-Nr. part-no.	Anforderungsstufe nach IEC performance level acc. to IEC	Kontaktoberfläche contact plating

Z (10:1)

Querschnitt der Lötanschlüsse:
cross-section of solder terminations:

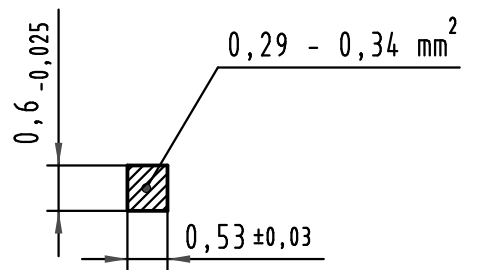

All Dimensions in mm Original Size DIN A 3		Techn. Character.		Nicht tolerierte Maße/Free size tolerances ergänzend/complementary IEC 60603-2	
		Dat.	Name	Maßstab/Scale	
		Detail.	23.11.09 Hage.	1:1	
		Insp.	23.11.09 LehT		
		Stand.			
36008	16.02.10	LehT	HARTING Electronics GmbH & Co. KG		TB 09 06 148 x901 222
35939			D-32339 ESPELKAMP		
Mod.	Dat.	Name	Sub.		Blatt/page