



**MICROCHIP**

---

**PAC1921**  
**High-Side Current/Power Sensor**  
**Evaluation Board**  
**User's Guide**

---

**Note the following details of the code protection feature on Microchip devices:**

- Microchip products meet the specification contained in their particular Microchip Data Sheet.
- Microchip believes that its family of products is one of the most secure families of its kind on the market today, when used in the intended manner and under normal conditions.
- There are dishonest and possibly illegal methods used to breach the code protection feature. All of these methods, to our knowledge, require using the Microchip products in a manner outside the operating specifications contained in Microchip's Data Sheets. Most likely, the person doing so is engaged in theft of intellectual property.
- Microchip is willing to work with the customer who is concerned about the integrity of their code.
- Neither Microchip nor any other semiconductor manufacturer can guarantee the security of their code. Code protection does not mean that we are guaranteeing the product as "unbreakable."

Code protection is constantly evolving. We at Microchip are committed to continuously improving the code protection features of our products. Attempts to break Microchip's code protection feature may be a violation of the Digital Millennium Copyright Act. If such acts allow unauthorized access to your software or other copyrighted work, you may have a right to sue for relief under that Act.

---

Information contained in this publication regarding device applications and the like is provided only for your convenience and may be superseded by updates. It is your responsibility to ensure that your application meets with your specifications. MICROCHIP MAKES NO REPRESENTATIONS OR WARRANTIES OF ANY KIND WHETHER EXPRESS OR IMPLIED, WRITTEN OR ORAL, STATUTORY OR OTHERWISE, RELATED TO THE INFORMATION, INCLUDING BUT NOT LIMITED TO ITS CONDITION, QUALITY, PERFORMANCE, MERCHANTABILITY OR FITNESS FOR PURPOSE. Microchip disclaims all liability arising from this information and its use. Use of Microchip devices in life support and/or safety applications is entirely at the buyer's risk, and the buyer agrees to defend, indemnify and hold harmless Microchip from any and all damages, claims, suits, or expenses resulting from such use. No licenses are conveyed, implicitly or otherwise, under any Microchip intellectual property rights.

**Trademarks**

The Microchip name and logo, the Microchip logo, dsPIC, FlashFlex, flexPWR, JukeBlox, KEELOQ, KEELOQ logo, Kleer, LANCheck, MediaLB, MOST, MOST logo, MPLAB, OptoLyzer, PIC, PICSTART, PIC<sup>32</sup> logo, RightTouch, SpyNIC, SST, SST Logo, SuperFlash and UNI/O are registered trademarks of Microchip Technology Incorporated in the U.S.A. and other countries.

The Embedded Control Solutions Company and mTouch are registered trademarks of Microchip Technology Incorporated in the U.S.A.

Analog-for-the-Digital Age, BodyCom, chipKIT, chipKIT logo, CodeGuard, dsPICDEM, dsPICDEM.net, ECAN, In-Circuit Serial Programming, ICSP, Inter-Chip Connectivity, KleerNet, KleerNet logo, MiWi, MPASM, MPF, MPLAB Certified logo, MPLIB, MPLINK, MultiTRAK, NetDetach, Omniscient Code Generation, PICDEM, PICDEM.net, PICkit, PICtail, RightTouch logo, REAL ICE, SQI, Serial Quad I/O, Total Endurance, TSHARC, USBCheck, VariSense, ViewSpan, WiperLock, Wireless DNA, and ZENA are trademarks of Microchip Technology Incorporated in the U.S.A. and other countries.

SQTP is a service mark of Microchip Technology Incorporated in the U.S.A.

Silicon Storage Technology is a registered trademark of Microchip Technology Inc. in other countries.

GestIC is a registered trademarks of Microchip Technology Germany II GmbH & Co. KG, a subsidiary of Microchip Technology Inc., in other countries.

All other trademarks mentioned herein are property of their respective companies.

© 2015, Microchip Technology Incorporated, Printed in the U.S.A., All Rights Reserved.

ISBN: 978-1-63277-460-6

**QUALITY MANAGEMENT SYSTEM  
CERTIFIED BY DNV  
= ISO/TS 16949 =**

*Microchip received ISO/TS-16949:2009 certification for its worldwide headquarters, design and wafer fabrication facilities in Chandler and Tempe, Arizona; Gresham, Oregon and design centers in California and India. The Company's quality system processes and procedures are for its PIC<sup>®</sup> MCUs and dsPIC<sup>®</sup> DSCs, KEELOQ<sup>®</sup> code hopping devices, Serial EEPROMs, microperipherals, nonvolatile memory and analog products. In addition, Microchip's quality system for the design and manufacture of development systems is ISO 9001:2000 certified.*

**Object of Declaration: PAC1921 High-Side Current/Power Sensor Evaluation Board**

EU Declaration of Conformity

Manufacturer: Microchip Technology Inc.  
2355 W. Chandler Blvd.  
Chandler, Arizona, 85224-6199  
USA

This declaration of conformity is issued by the manufacturer.

The development/evaluation tool is designed to be used for research and development in a laboratory environment. This development/evaluation tool is not a Finished Appliance, nor is it intended for incorporation into Finished Appliances that are made commercially available as single functional units to end users under EU EMC Directive 2004/108/EC and as supported by the European Commission's Guide for the EMC Directive 2004/108/EC (8<sup>th</sup> February 2010).

This development/evaluation tool complies with EU RoHS2 Directive 2011/65/EU.

This development/evaluation tool, when incorporating wireless and radio-telecom functionality, is in compliance with the essential requirement and other relevant provisions of the R&TTE Directive 1999/5/EC and the FCC rules as stated in the declaration of conformity provided in the module datasheet and the module product page available at [www.microchip.com](http://www.microchip.com).

For information regarding the exclusive, limited warranties applicable to Microchip products, please see Microchip's standard terms and conditions of sale, which are printed on our sales documentation and available at [www.microchip.com](http://www.microchip.com).

Signed for and on behalf of Microchip Technology Inc. at Chandler, Arizona, USA

  
Derek Carlson  
VP Development Tools

12-Sep-14  
Date

# PAC1921 High-Side Current/Power Sensor Evaluation Board User's Guide

---

---

NOTES:

## Table of Contents

<b>Preface</b> .....	<b>7</b>
Introduction.....	7
Document Layout .....	7
Conventions Used in this Guide .....	8
Warranty Registration.....	8
Recommended Reading.....	9
The Microchip Web Site .....	9
Customer Support .....	9
Document Revision History .....	9
<b>Chapter 1. Product Overview</b>	
1.1 Introduction .....	11
1.2 PAC1921 Evaluation System .....	11
1.3 What is the PAC1921 High-Side Current/Power Sensor Evaluation Board? .....	12
1.3.1 Board Layout .....	12
1.4 What the PAC1921 High-Side Current/Power Sensor Evaluation Board Kit Contains.....	13
<b>Chapter 2. Installation and Operation</b>	
2.1 Getting Started .....	15
2.1.1 System Requirements .....	15
2.2 Installing the Evaluation Board Software.....	15
2.3 Microchip USB Bridge Installation .....	19
<b>Chapter 3. Hardware Description</b>	
3.1 Introduction.....	21
3.1.1 Power Source.....	21
3.2 USB-to-SMBus Bridge.....	21
3.2.1 Direct SMBus Connect Option .....	21
3.3 Operating Mode.....	22
3.3.1 SMBus Mode.....	22
3.4 LED Indicators.....	22
3.5 Jumper Settings .....	23
3.6 Test Points .....	24
3.7 Demo Mode Setup and Operation.....	25
3.8 Sys Mode Setup and Operation .....	25
3.8.1 Jumper Positions.....	25
3.8.2 Load Connection .....	25

## Chapter 4. Software Description

4.1 Overview .....	27
4.1.1 Tips for Using the Evaluation Board GUI .....	28
4.2 Interface Description and Operation.....	29
4.2.1 Panel Control Section .....	29
4.2.2 Main Configuration Panel.....	31
4.2.3 Overflow Status Panel .....	32
4.2.4 R <sub>sense</sub> Panel .....	32
4.2.5 Panel and Integration Control Panel .....	32
4.2.6 EVB Demo Configuration Panel.....	33
4.3 Tab Descriptions .....	34
4.3.1 Vbus & Vsense Tab .....	34
4.3.2 Vbus, Vsense and Vpower Tabs.....	35
4.3.3 Calculations/File IO Tab.....	36
4.3.4 Integration Table Tab.....	38
4.4 Evaluation Board Examples .....	39
4.4.1 Power Pin-Controlled Integration Example .....	39
4.4.2 Power Free-Run Integration Example.....	42
4.5 Troubleshooting.....	45
4.5.1 GUI Controls Unresponsive After Installation .....	45
4.5.2 GUI Freezes.....	45

## Appendix A. Schematic and Layouts

A.1 Introduction .....	47
A.2 Board – PAC1921 Current Shunt and Power Monitor Schematic.....	48
A.3 Board – USB Bridge and Sig Gen Schematic.....	49
A.4 Board – Top Silk .....	50
A.5 Board – Top Copper and Silk.....	50
A.6 Board – Top Copper .....	51
A.7 Board – Bottom Copper .....	51
A.8 Board – Bottom Copper and Silk .....	52
A.9 Board – Bottom Silk .....	52

## Appendix B. Bill of Materials (BOM) .....53

## Worldwide Sales and Service .....56

---

---

## Preface

---

---

### NOTICE TO CUSTOMERS

All documentation becomes dated, and this manual is no exception. Microchip tools and documentation are constantly evolving to meet customer needs, so some actual dialogs and/or tool descriptions may differ from those in this document. Please refer to our web site ([www.microchip.com](http://www.microchip.com)) to obtain the latest documentation available.

Documents are identified with a “DS” number. This number is located on the bottom of each page, in front of the page number. The numbering convention for the DS number is “DSXXXXXXXXA”, where “XXXXXXXX” is the document number and “A” is the revision level of the document.

For the most up-to-date information on development tools, see the MPLAB® IDE on-line help. Select the Help menu, and then Topics to open a list of available on-line help files.

## INTRODUCTION

This chapter contains general information that will be useful to know before using the PAC1921 High-Side Current/Power Sensor Evaluation Board. Items discussed in this chapter include:

- [Document Layout](#)
- [Conventions Used in this Guide](#)
- [Warranty Registration](#)
- [Recommended Reading](#)
- [The Microchip Web Site](#)
- [Customer Support](#)
- [Document Revision History](#)

## DOCUMENT LAYOUT

This document describes how to use the PAC1921 High-Side Current/Power Sensor Evaluation Board as a development tool to emulate and debug firmware on a target board. The manual layout is as follows:

- **Chapter 1. “Product Overview”** – Important information about the PAC1921 High-Side Current/Power Sensor Evaluation Board.
- **Chapter 2. “Installation and Operation”** – Includes instructions on installing and starting the application.
- **Chapter 3. “Hardware Description”** – Shows hardware details of the PAC1921 High-Side Current/Power Sensor Evaluation Board.
- **Chapter 4. “Software Description”** – Describes the main operations in the software.
- **Appendix A. “Schematic and Layouts”** – Shows the schematic and layout diagrams for the PAC1921 High-Side Current/Power Sensor Evaluation Board.
- **Appendix B. “Bill of Materials (BOM)”** – Lists the parts used to build the PAC1921 High-Side Current/Power Sensor Evaluation Board.

## CONVENTIONS USED IN THIS GUIDE

This manual uses the following documentation conventions:

### DOCUMENTATION CONVENTIONS

Description	Represents	Examples
<b>Arial font:</b>		
Italic characters	Referenced books	<i>MPLAB® IDE User's Guide</i>
	Emphasized text	...is the <i>only</i> compiler...
Initial caps	A window	the Output window
	A dialog	the Settings dialog
	A menu selection	select Enable Programmer
Quotes	A field name in a window or dialog	"Save project before build"
Underlined, italic text with right angle bracket	A menu path	<u><i>File&gt;Save</i></u>
Bold characters	A dialog button	Click <b>OK</b>
	A tab	Click the <b>Power</b> tab
N'Rnnnn	A number in verilog format, where N is the total number of digits, R is the radix and n is a digit.	4'b0010, 2'hF1
Text in angle brackets < >	A key on the keyboard	Press <Enter>, <F1>
<b>Courier New font:</b>		
Plain Courier New	Sample source code	#define START
	Filenames	autoexec.bat
	File paths	c:\mcc18\h
	Keywords	_asm, _endasm, static
	Command-line options	-Opa+, -Opa-
	Bit values	0, 1
	Constants	0xFF, 'A'
Italic Courier New	A variable argument	<i>file.o</i> , where <i>file</i> can be any valid filename
Square brackets [ ]	Optional arguments	mcc18 [options] <i>file</i> [options]
Curly brackets and pipe character: {   }	Choice of mutually exclusive arguments; an OR selection	errorlevel {0 1}
Ellipses...	Replaces repeated text	var_name [, var_name...]
	Represents code supplied by user	void main (void) { ... }

## WARRANTY REGISTRATION

Please complete the enclosed Warranty Registration Card and mail it promptly. Sending in the Warranty Registration Card entitles users to receive new product updates. Interim software releases are available at the Microchip web site.



## RECOMMENDED READING

This user's guide describes how to use PAC1921 High-Side Current/Power Sensor Evaluation Board. Other useful documents are listed below. The following Microchip documents are available and recommended as supplemental reference resources.

### **PAC1921 Data Sheet (DS20005293)**

This data sheet describes the operation and features of the PAC1921 high-side power/current monitor device with a configurable analog output.

## THE MICROCHIP WEB SITE

Microchip provides online support via our web site at [www.microchip.com](http://www.microchip.com). This web site is used as a means to make files and information easily available to customers. Accessible by using your favorite Internet browser, the web site contains the following information:

- **Product Support** – Data sheets and errata, application notes and sample programs, design resources, user's guides and hardware support documents, latest software releases and archived software
- **General Technical Support** – Frequently Asked Questions (FAQs), technical support requests, online discussion groups, Microchip consultant program member listing
- **Business of Microchip** – Product selector and ordering guides, latest Microchip press releases, listing of seminars and events, listings of Microchip sales offices, distributors and factory representatives

## CUSTOMER SUPPORT

Users of Microchip products can receive assistance through several channels:

- Distributor or Representative
- Local Sales Office
- Field Application Engineer (FAE)
- Technical Support

Customers should contact their distributor, representative or field application engineer (FAE) for support. Local sales offices are also available to help customers. A listing of sales offices and locations is included in the back of this document.

Technical support is available through the web site at:

<http://www.microchip.com/support>

## DOCUMENT REVISION HISTORY

### **Revision A (June 2015)**

- Initial Release of this Document.

NOTES:

---

---

## Chapter 1. Product Overview

---

---

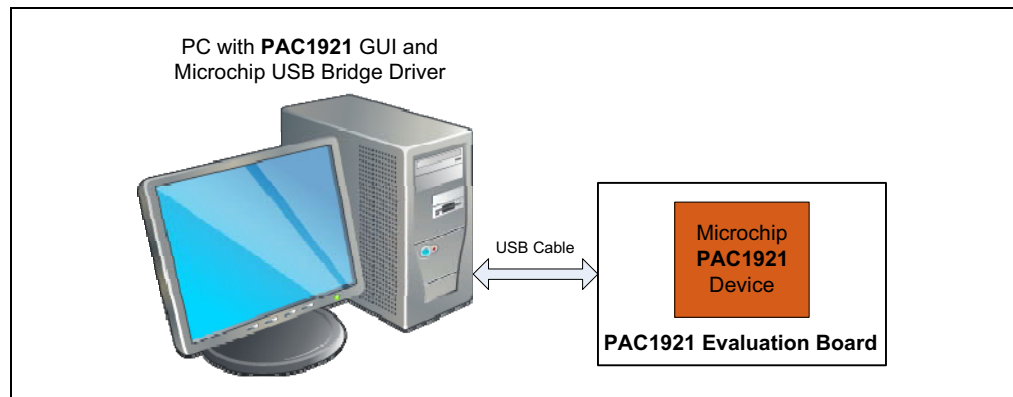
### 1.1 INTRODUCTION

The PAC1921 is a dedicated power monitoring device with a configurable output. The PAC1921 High-Side Current/Power Sensor Evaluation Board package provides users with the means to exercise device functionality while connected either to target systems (Sys mode) or while utilizing on-board sources (Demo mode).

### 1.2 PAC1921 EVALUATION SYSTEM

The evaluation system has three major parts, as shown in [Figure 1-1](#):

- Customer-provided Windows<sup>®</sup> PC with an available USB port
- Microchip PAC1921 Graphical User Interface (GUI) (based on National Instruments<sup>™</sup> LabVIEW<sup>™</sup> software)
- Microchip PAC1921 High-Side Current/Power Sensor Evaluation Board
- USB Cable for GUI communications (Standard-A plug to Mini-B plug)



**FIGURE 1-1:** PAC1921 Evaluation System.

**Note:** Screen captures in this document were taken on a PC with Windows<sup>®</sup> 7 Professional using the default desktop colors. The colors on your screen may vary, especially if a Windows theme has been applied on the PC.

## 1.3 WHAT IS THE PAC1921 HIGH-SIDE CURRENT/POWER SENSOR EVALUATION BOARD?

The evaluation system is comprised of the ADM00592 and a LabVIEW software-based application which allows the user to do the following:

- View and change register values
- Saving settings of all registers allowing for quick configuration at a later time
- Graphing registers

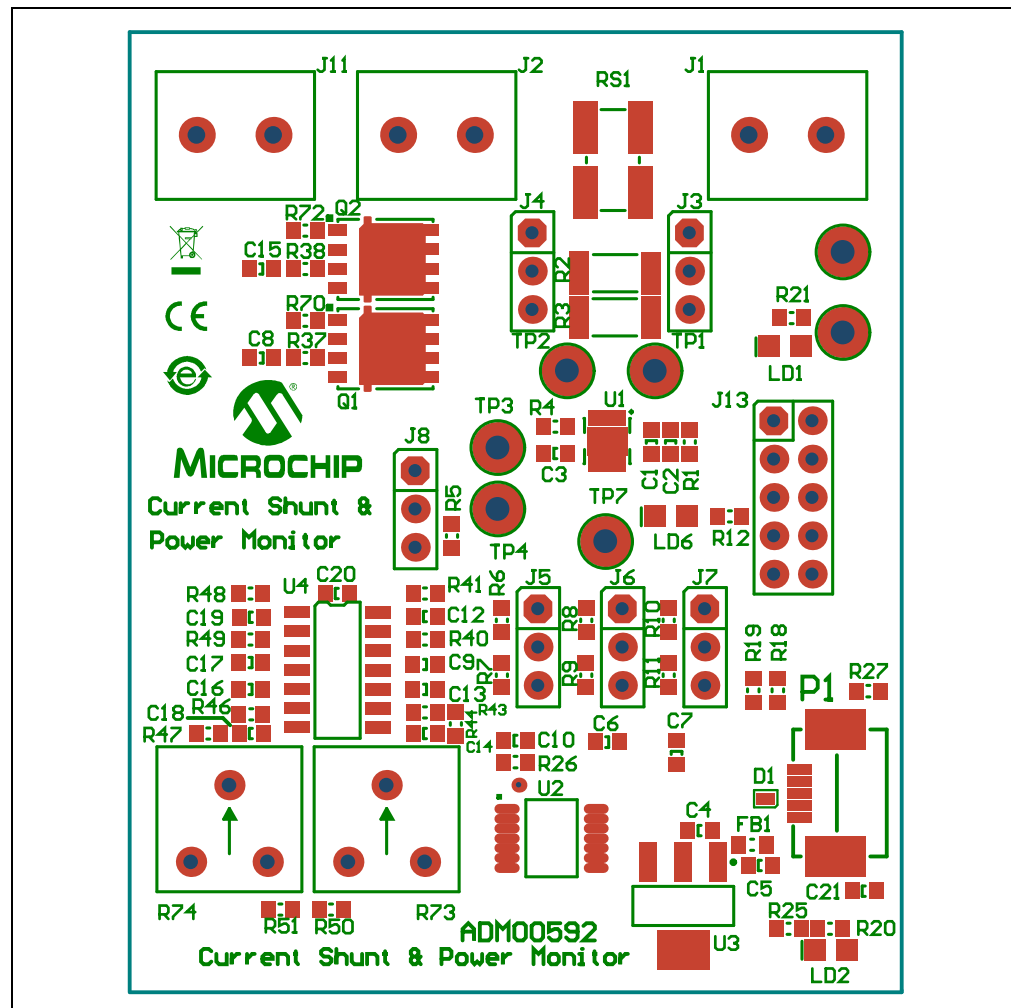
The hardware platform provides the following features to the user:

- Headers for connecting a sense resistor
- USB-to-SMBus bridge for communications
- Capability to connect directly to an external SMBus master

### 1.3.1 Board Layout

The evaluation board was designed for ease of use and user experimentation.

Figure 1-2 shows the top silkscreen for the board.



**FIGURE 1-2:** PAC1921 High-Side Current/Power Sensor Evaluation Board – Top Silkscreen.

### 1.4 WHAT THE PAC1921 HIGH-SIDE CURRENT/POWER SENSOR EVALUATION BOARD KIT CONTAINS

This PAC1921 High-Side Current/Power Sensor Evaluation Board kit includes:

- PAC1921 High-Side Current/Power Sensor Evaluation Board (ADM00592)
- Supplied USB Mini Connector Cable
- Important Information Sheet

NOTES:

---

---

## Chapter 2. Installation and Operation

---

---

### 2.1 GETTING STARTED

#### 2.1.1 System Requirements

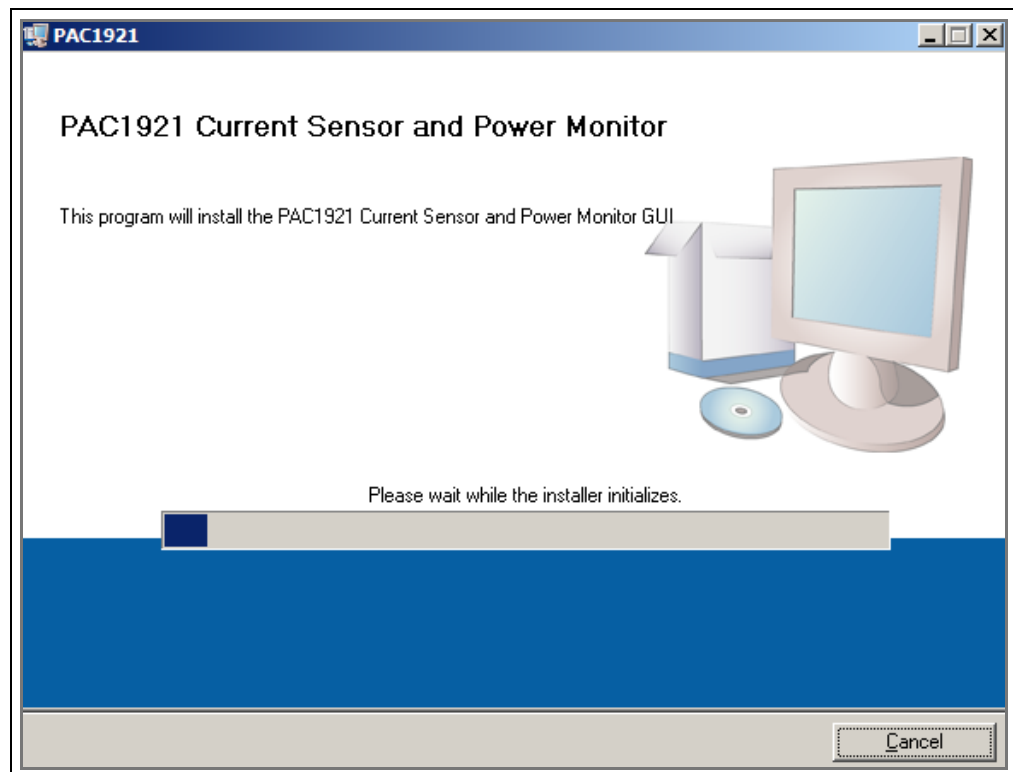
To use the PAC1921 High-Side Current/Power Sensor Evaluation Board, the following are required:

- A PC running the Microsoft® Windows® operating system
- A display resolution of 800x600 or larger, for viewing several windows simultaneously
- An available USB port

### 2.2 INSTALLING THE EVALUATION BOARD SOFTWARE

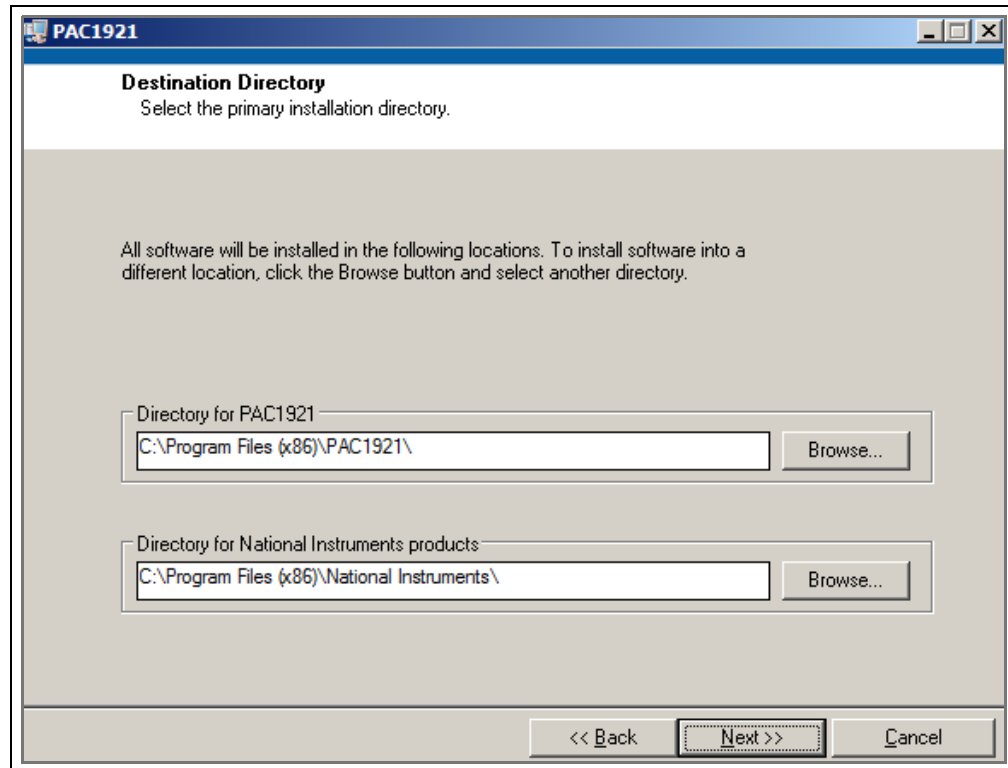
Follow these steps in order to install the board's Graphical User Interface (GUI):

1. Download the software archive from the board's web page, unzip it and double-click the `Setup.exe` to start the installation. [Figure 2-1](#) shows the initial installation screen, which displays briefly as the setup program loads.



**FIGURE 2-1:** *Software Installation – Initialize Window.*

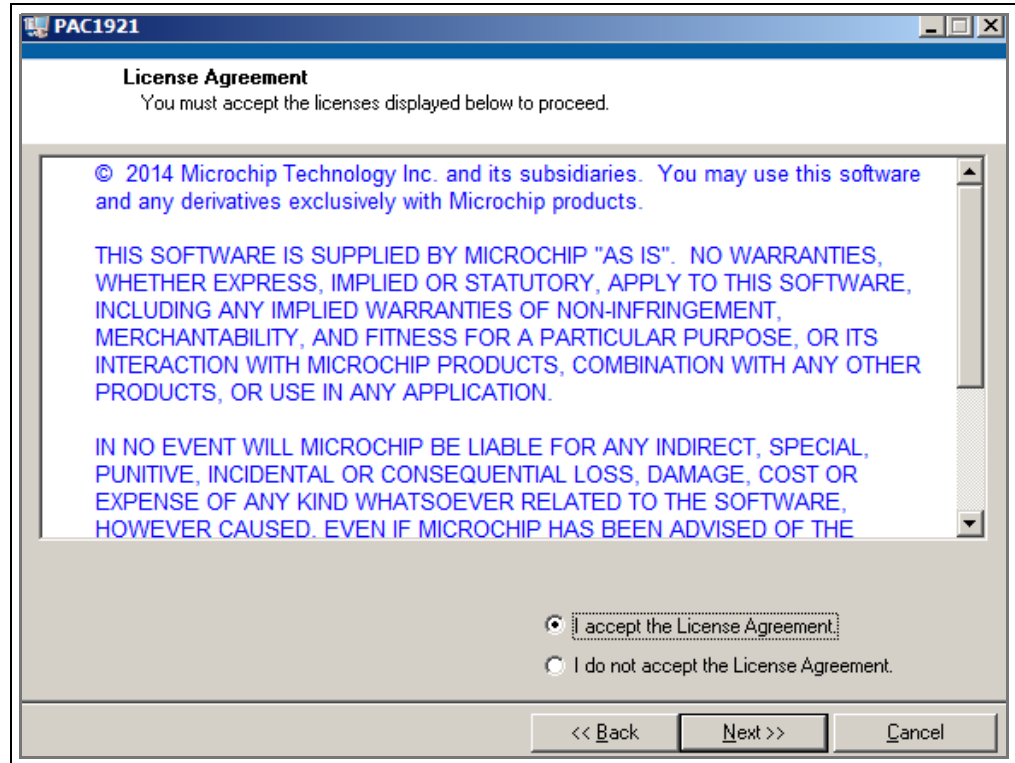
2. Click **Next** in the Destination Directory window, shown in [Figure 2-2](#). For proper operation, the files must be installed in the default locations. The default location for the software files is C:\Program Files (x86)\Microchip\PAC1921 and for the LabVIEW™ software is C:\Program Files\National Instruments.



**FIGURE 2-2:** Software Installation – Setting the Destination Directory.

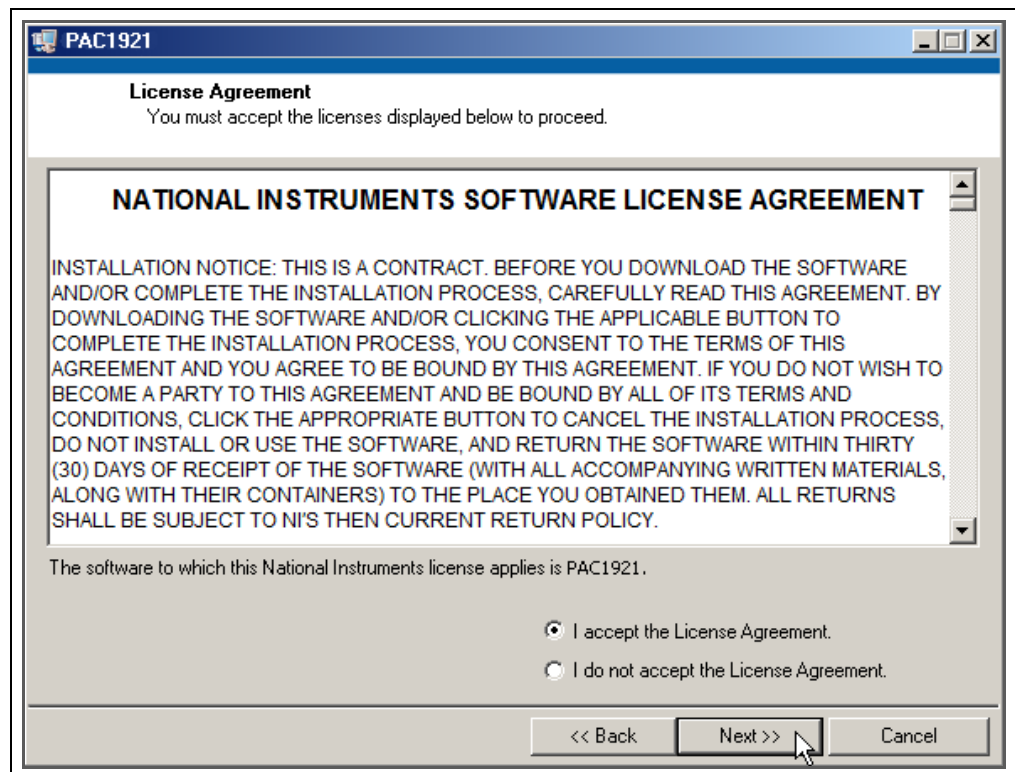


3. Read and accept the license agreement, then click **Next**.



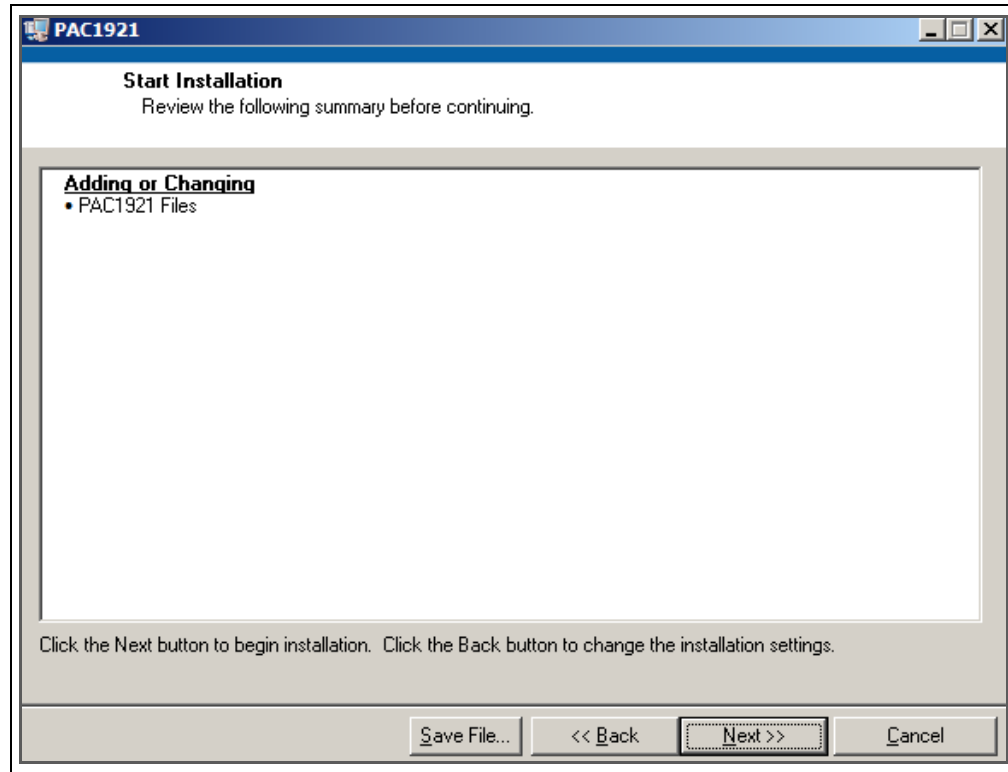
**FIGURE 2-3:** *Software Installation – Software License Agreement.*

4. To use the LabVIEW software, read and accept the license agreement, then click **Next**.

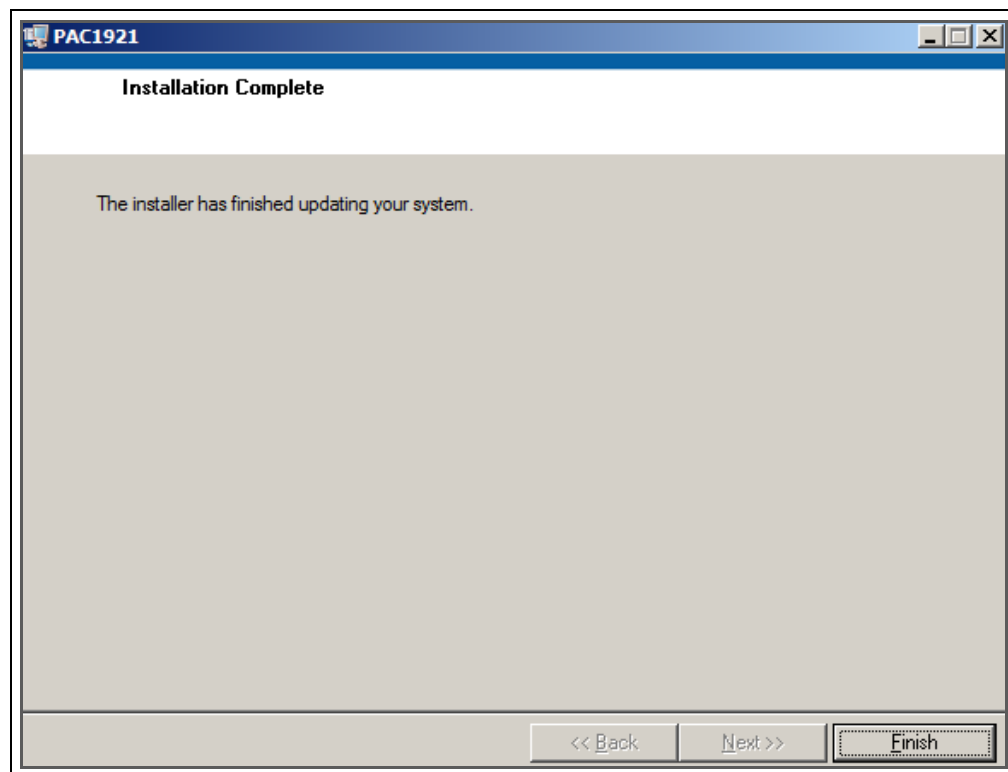


**FIGURE 2-4:** *Software Installation – LabVIEW™ Software License Agreement.*

5. Follow the on-screen instructions to complete the installation. During installation, shortcuts will be created on the Windows Start Menu under *Programs>PAC1921* and on the desktop.

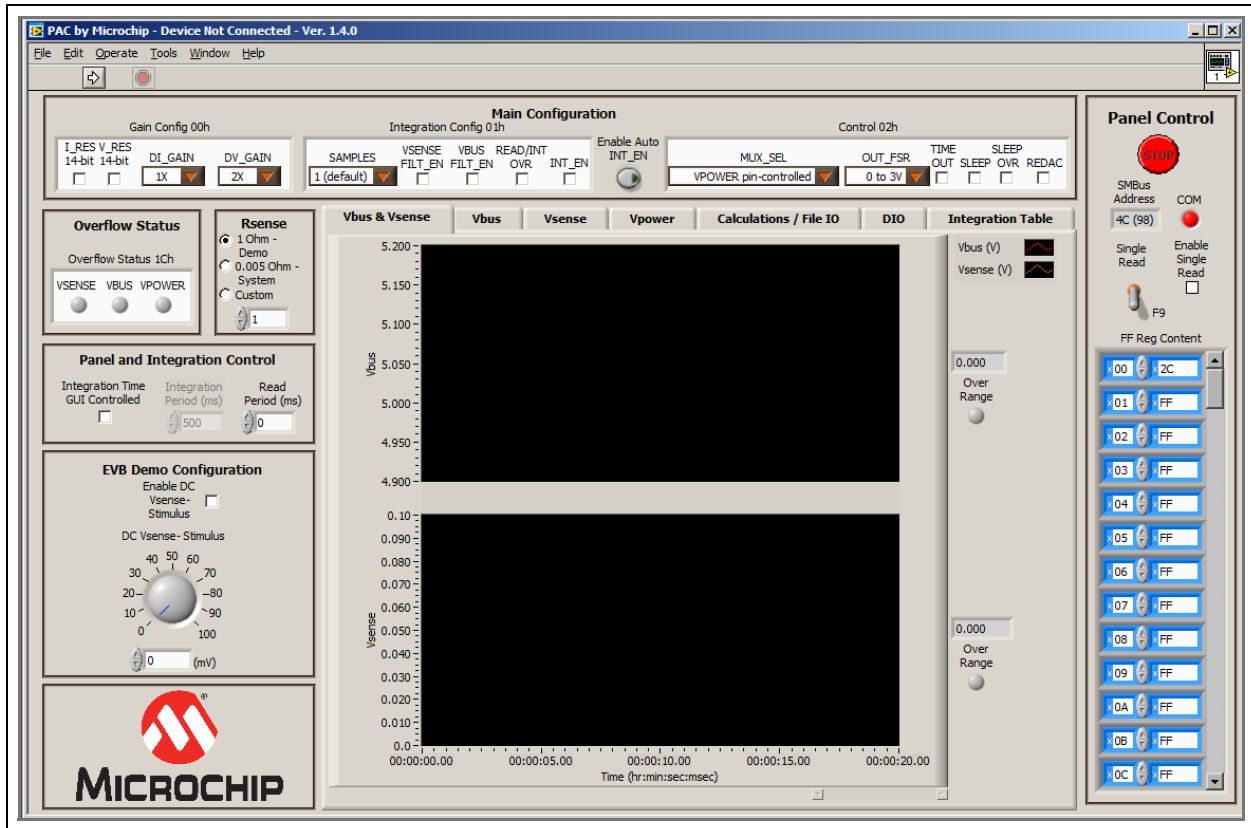


**FIGURE 2-5:** Software Installation – LabVIEW™ Software Installation Screen.



**FIGURE 2-6:** Software Installation – LabVIEW™ Software Installation Complete.

When the installation is complete, the program will automatically run (see Figure 2-7).



**FIGURE 2-7:** PAC1921 GUI Start-up Screen.

## 2.3 MICROCHIP USB BRIDGE INSTALLATION

Connect the USB mini connector to the evaluation board and the standard USB connector to any available USB port on the PC. If the Microchip USB bridge driver has not previously been installed on the selected USB port, download the MCP2221 Windows driver and installer from [www.microchip.com](http://www.microchip.com) at:

<http://www.microchip.com/wwwproducts/Devices.aspx?product=MCP2221>

Follow the on-screen instructions to complete the installation process.

NOTES:

---

---

## Chapter 3. Hardware Description

---

---

### 3.1 INTRODUCTION

The PAC1921 High-Side Current/Power Sensor Evaluation Board provides the means to evaluate features, and to view and modify registers. There are two modes for using the evaluation board:

- Demo mode: Monitors an on-board power source
- Sys mode: Monitors an external power source

LEDs indicate status information and test points are included to monitor system voltages with a user-provided voltmeter or oscilloscope.

The PAC1921 device is an SMBus-compliant, high-side current/power monitor in a 10-pin, 3 mm x 3 mm DFN package. For details regarding the PAC1921 device, refer to the “PAC1921 Data Sheet” (DS20005293).

#### 3.1.1 Power Source

The board requires only one Universal Serial Bus (USB) connection to power the board. USB bus voltage is provided to the on-board test power sources and the USB-to-SMBus bridge. The evaluation board circuitry uses the on-board regulator to regulate the +5V USB power to +3.3V.

### 3.2 USB-TO-SMBus BRIDGE

The USB-to-SMBus is based on the MCP2221 USB-to-I<sup>2</sup>C™ protocol converter, which provides the interface between the USB and the SMBus. Power is sourced to the microcontroller from the USB interface for device power and communication.

#### 3.2.1 Direct SMBus Connect Option

It is also possible to connect an external SMBus master to the PAC1921 High-Side Current/Power Sensor Evaluation Board. A few modifications to the board are required, as explained below:

- Remove the jumpers on J13 and connect the SMBus master to the SMBus\_DATA, SMBus\_CLK and #READ/INT pins, as well as an external supply for +3.3V. Note that a return is also provided on this header for convenience (GND).
- The +3.3V can be supplied by the SMBus bridge by leaving the +3.3V jumper in place and retaining the USB connection.

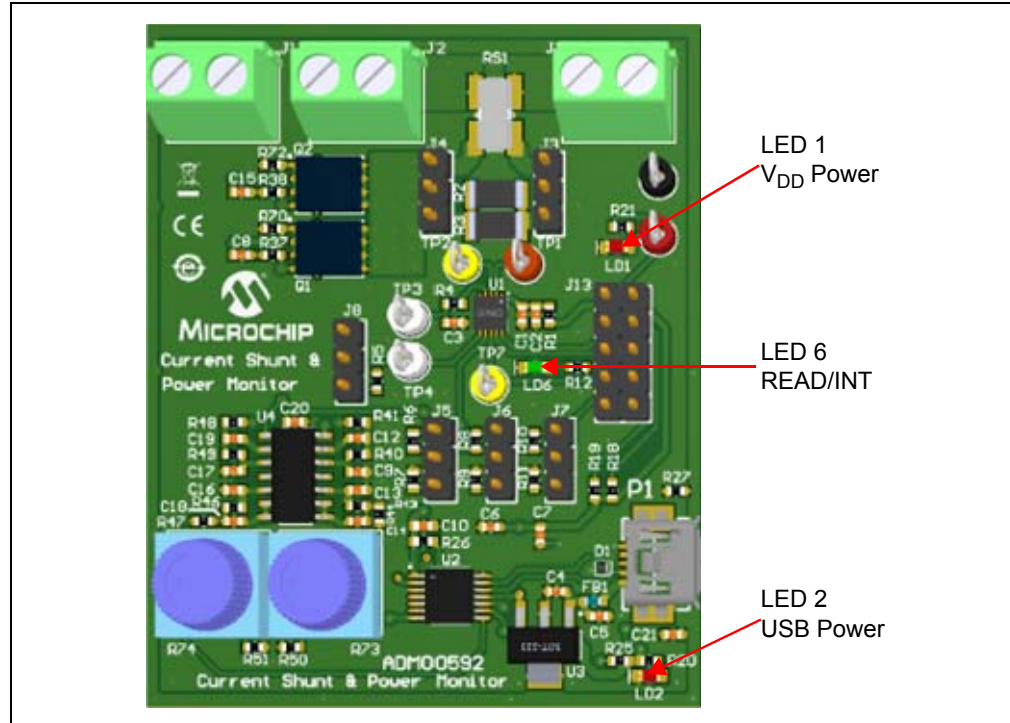
## 3.3 OPERATING MODE

### 3.3.1 SMBus Mode

By default, the evaluation board is configured so that the PAC1921 operates in SMBus mode with an SMBus address of, 1001\_100xb (98h). The address can be changed to 1001\_101xb (9Ah) by moving jumper J8 to position 2-3. Cycle power to the evaluation board in order for the change to take effect.

## 3.4 LED INDICATORS

LED locations are indicated in [Figure 3-1](#).



**FIGURE 3-1:** LED Indicator Locations.

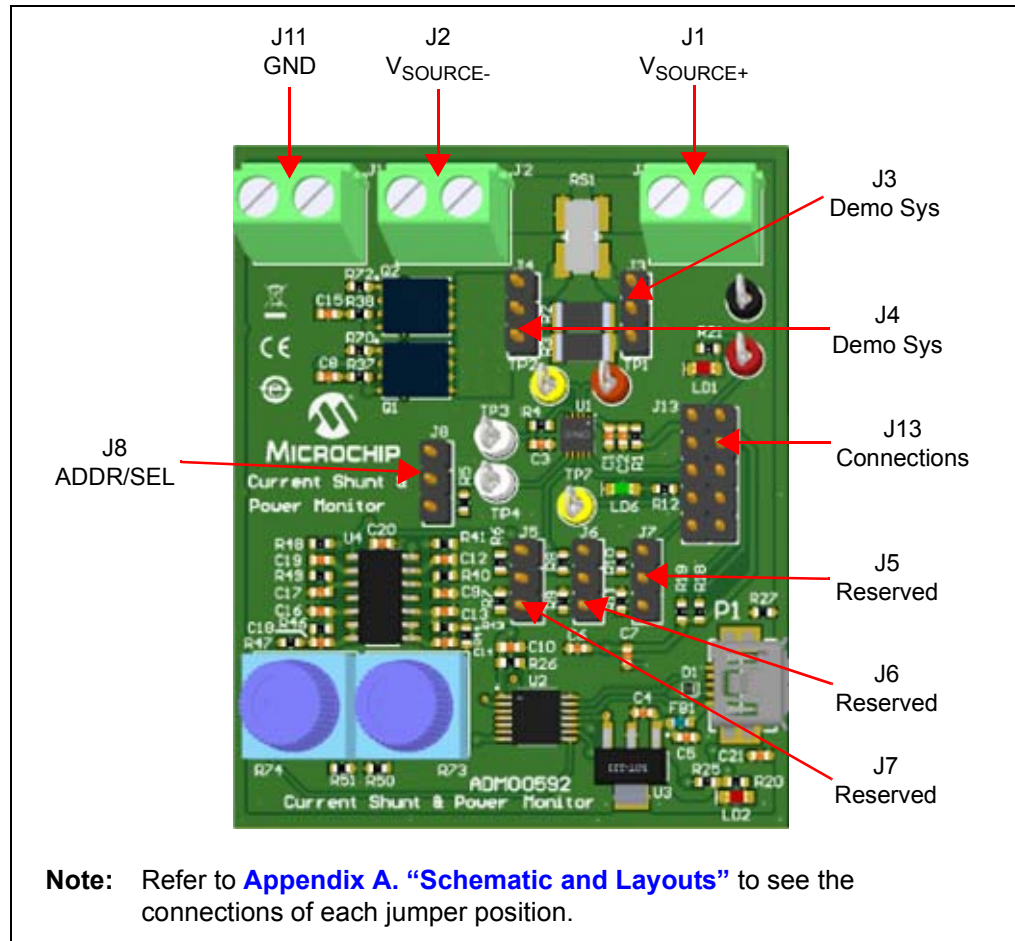
LEDs indicate the status of the signals, as described in [Table 3-1](#):

**TABLE 3-1: LED STATUS INDICATORS**

LED	Signal	OFF	Green	Red
LD1	V <sub>DD</sub> Power	V <sub>DD</sub> is not present	N/A	V <sub>DD</sub> is present
LD2	+5V USB Power	USB power is not present	N/A	+5V USB power is present
LD6	READ/INT	Pin is not asserted (Read State)	Pin is asserted (Integrate State)	N/A

## 3.5 JUMPER SETTINGS

This evaluation board has pin headers and jumper configurations to evaluate the features of the PAC1921. Jumper locations are indicated in [Figure 3-2](#).



**FIGURE 3-2:** Jumper and External Connection Locations.

# PAC1921 High-Side Current/Power Sensor Evaluation Board User's Guide

Jumper settings are described in [Table 3-2](#).

**TABLE 3-2: JUMPER SETTINGS**

Pin Header	Label	Default Position	Alternate Position(s)
J1, J2	Vsource+, Vsource-	External power source terminals. (See <a href="#">Section 3.8.2 “Load Connection”</a> .)	
J3, J4	Demo Sys	Select Demo mode R <sub>SENSE+/-</sub> . Positions 3-2 are jumpered on both jumpers. (See <a href="#">Section 3.7 “Demo Mode Setup and Operation”</a> .)	Select Sys mode R <sub>SENSE+/-</sub> . Positions 1-2 are jumpered on both jumpers. (See <a href="#">Section 3.8 “Sys Mode Setup and Operation”</a> .)
J5, J6, J7	Reserved	Reserved for future use	
J8	J8 (ADDR_SEL) (See <a href="#">Section 3.3.1 “SMBus Mode”</a> )	In SMBus mode, sets SMBus address to 1001_100b at power-up. Positions 1-2 are jumpered.	In SMBus mode, sets SMBus address to 1001_101b at power-up. Positions 2-3 are jumpered.
J11	GND		Connect ground from external source for Sys mode.
J13	GND, #READ/INT, SMBus_DATA, SMBus_CLK, VDD	USB bridge generates on-board 3.3V and provides SMBus host. Positions 1-2, 3-4, 5-6, 7-8, 9-10 are all jumpered.	(See <a href="#">Section 3.2.1 “Direct SMBus Connect Option”</a> .)

## 3.6 TEST POINTS

The PAC1921 High-Side Current/Power Sensor Evaluation Board provides test points for ground reference and signal access. [Table 3-3](#) summarizes these test points.

**TABLE 3-3: TEST POINTS**

Test Point	Marking	Signal Function Monitored
1	Vsense+ (orange)	SENSE+
2	Vsense- (yellow)	SENSE-
3	OUT (white)	OUT Pin
4	ADDR_SEL	SMBus Address Select
5	Vdd (red)	V <sub>DD</sub>
6	GND (black)	Ground
7	#READ/INT (yellow)	$\overline{\text{READ/INT}}$ Pin



## 3.7 DEMO MODE SETUP AND OPERATION

Demo mode uses an on-board current source to exercise and demonstrate the features of the PAC1921 power monitor. The 100 mV constant-current source is provided using a +5V USB as the supply. Parallel sense resistors are provided to convert the current to a corresponding voltage for the PAC1921 to read at the SENSE+ and SENSE- inputs. The evaluation board is assembled with jumpers J3 and J4 positioned for Demo mode (see [Section 3.5 “Jumper Settings”](#)). Current is controlled by the evaluation board Demo Configuration section of the evaluation board GUI (see [Section 4.2.6 “EVB Demo Configuration Panel”](#)).

## 3.8 SYS MODE SETUP AND OPERATION

Sys mode uses external current sources to exercise and demonstrate the features of the PAC1921 power monitor.

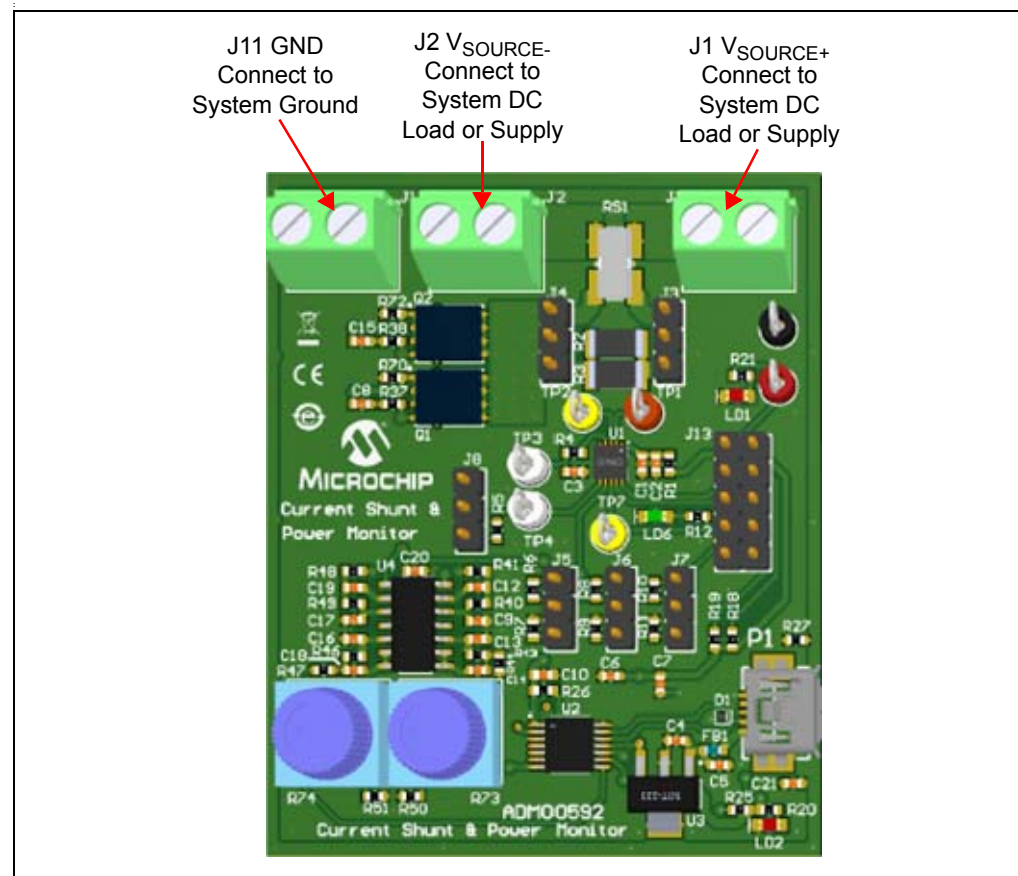
### 3.8.1 Jumper Positions

To use Sys mode, reposition jumpers J3 and J4 (see [Table 3-2](#)) to disconnect the on-board demonstration current sources.

### 3.8.2 Load Connection

A 5 milliohm (1% tolerance) sense resistor, connected between J1 and J2, is provided on-board the PAC1921 evaluation board to measure system current.

Load connections to the system can be established, as shown in [Figure 3-3](#).



**FIGURE 3-3:** Load Connection Location.

NOTES:

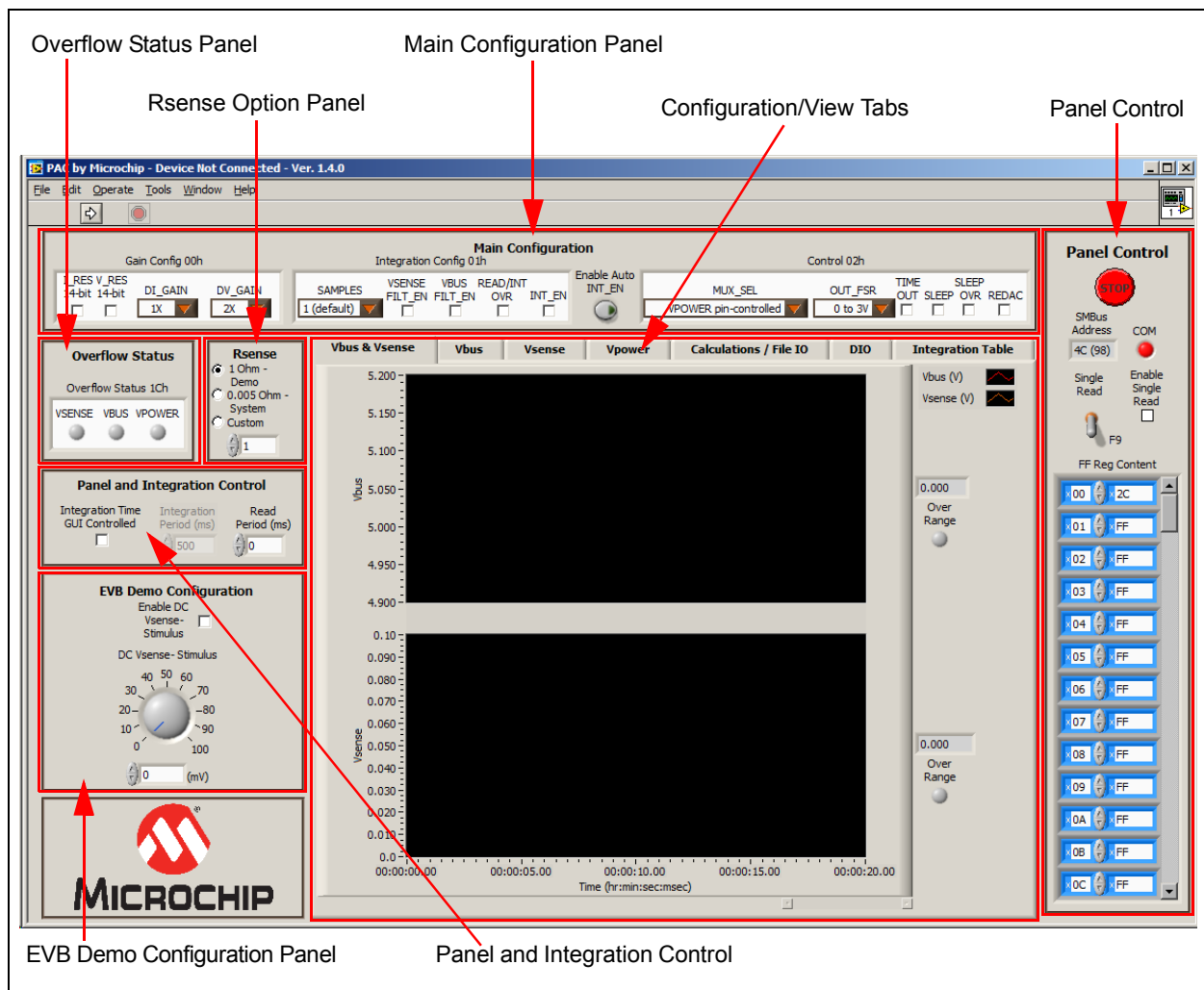
## Chapter 4. Software Description

### 4.1 OVERVIEW

To get the Graphical User Interface (GUI) and the Evaluation Board (EVB) running, follow these instructions:

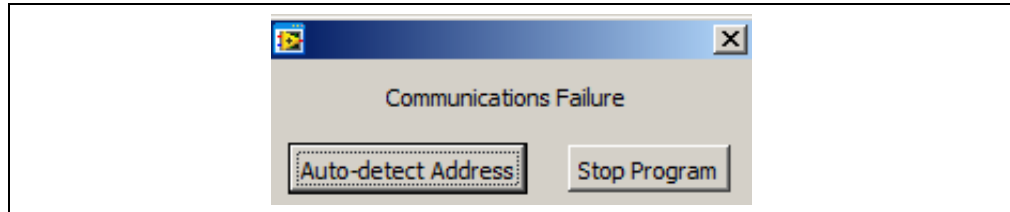
1. Start the PAC1921 GUI software: from the Windows Start menu, select *Programs>PAC1921*.
2. Connect the USB mini connector end of the cable to the board and the standard USB connector of the cable to any available USB port on the PC. The  $V_{DD}$  and USB power LEDs (LD1 and LD2, respectively) will illuminate RED, indicating that the PAC1921 is powered up and the MCP2221 USB bridge is connected to the PC.

The PAC1921 High-Side Current/Power Sensor Evaluation Board Graphical User Interface (GUI) is shown in [Figure 4-1](#).



**FIGURE 4-1:** GUI Interface Panel.

When the evaluation board is connected or disconnected, a message displays as shown in [Figure 4-2](#). With the evaluation board connected, click **Auto-detect Address** to restart communications.



**FIGURE 4-2:** Communications Failure Message.

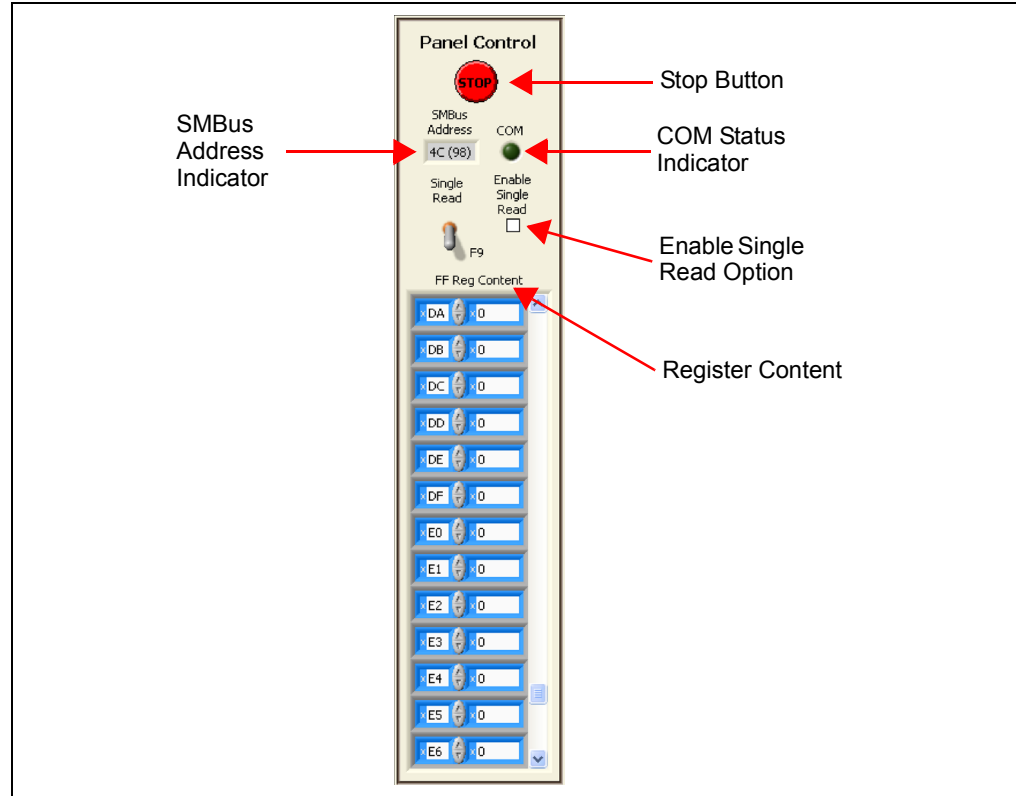
## 4.1.1 Tips for Using the Evaluation Board GUI

- After a power-up of the evaluation board, the default settings are loaded. Users can save the setting configurations to user-named files, which can be reloaded at any time for quick reconfiguration (see [Section 4.3.3.1 “Configuration Save and Load”](#)).
- To configure the GUI and PAC1921 for free-run integration power measurement, press the <F2> function key on the keyboard.
- To reload the PAC1921 register defaults, press the <F6> function key on the keyboard.
- When using the GUI, the PAC1921 can enter a Sleep state; however, it wakes to service the GUI SMBus communications, then returns to Sleep. For this reason, the current consumption will be slightly higher than expected in Sleep state when using the GUI.
- When the PAC1921 enters Sleep state, the PAC1921 clears the measurement registers, and consequently, the GUI **Calculations/File IO** tab is cleared. To prevent the PAC1921 from entering Sleep, check the “SLEEP OVR” box in the Main Configuration section.

## 4.2 INTERFACE DESCRIPTION AND OPERATION

### 4.2.1 Panel Control Section

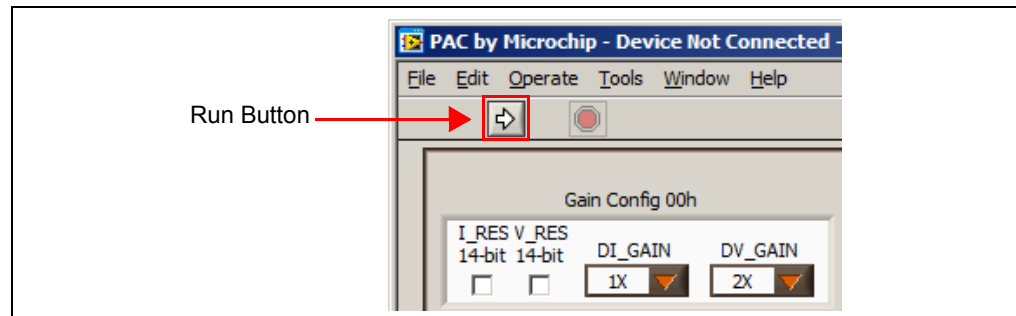
The Panel Control section on the right side of the GUI, shown in [Figure 4-3](#), affects the GUI operation.



**FIGURE 4-3:** Panel Control Section.

#### 4.2.1.1 STOP AND RUN BUTTONS

Pressing the **Stop** button, as shown in [Figure 4-3](#), interrupts the GUI software communications with the evaluation board. When the **Stop** button is clicked, the **Run** button is displayed on the menu bar (see [Figure 4-4](#)).



**FIGURE 4-4:** Run Button.

To restart the communication between the software and the evaluation board, click the **Run** button. The arrow button disappears when the communications resume.

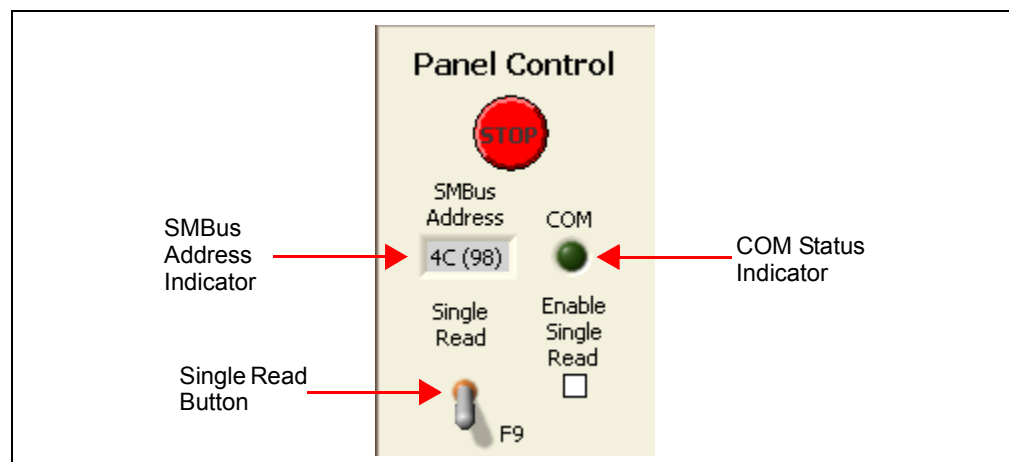
**Note 1:** Stopping and restarting the GUI does not affect register settings. To restore default register settings, disconnect power from the evaluation board, then reconnect power.

**2:** Stopping the GUI clears the “Enable DC Vsense- Stimulus” box (see [Section 4.2.6 “EVB Demo Configuration Panel”](#)).

To close the program, use the **Close (X)** button in the upper right corner of the window.

## 4.2.1.2 SMBus ADDRESS

The “SMBus Address” box, shown in [Figure 4-5](#), indicates the selected SMBus address. The SMBus address can be changed by moving a jumper (see [Section 3.3.1 “SMBus Mode”](#)).



**FIGURE 4-5:** SMBus Address Indicator.

## 4.2.1.3 COM STATUS INDICATOR

The “COM” status indicator, on the right side of the panel as shown in [Figure 4-5](#), indicates the status of communications over the SMBus. During normal operation, the “COM” indicator is black. If the SMBus communications fail, the “COM” indicator turns red.

## 4.2.1.4 SINGLE READ/CONTINUOUS READ

The panel defaults to continuous register reads (toggle switch in down position, as shown in [Figure 4-5](#)). To stop continuous register reads, check the “Enable Single Read” box. In order to capture the register values at a given time, click the switch, which will briefly flip to “Single Read”.

## 4.2.1.5 REGISTER CONTENT

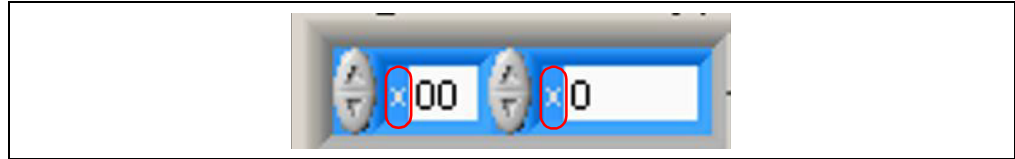
“Reg Content”, shown in [Figure 4-3](#), is a scrollable list of the PAC1921 registers and the last read value. It is important to note that not all addresses are physical memory locations on the device; these registers will read ‘0’. Likewise, some registers shown (undocumented in the data sheet) may have data. Editing these registers can cause unexpected results.

To update a register value, locate the register address in the left column, type the new value in the corresponding cell in the right column, and press **Enter** on the keyboard or click on another part of the GUI.

## 4.2.1.5.1 Numbering Systems Views

The “Reg Content” section allows values to be displayed using different numbering systems: Decimal, Hex, Octal, Binary or SI Notation.

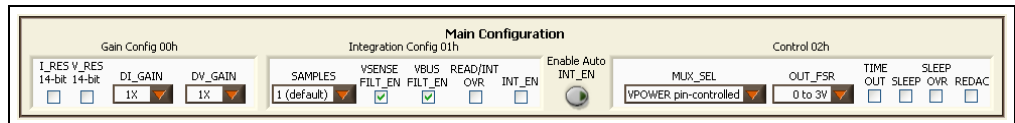
To view a value using a different numbering system, click the indicator to the left of the value in the cell, shown circled in [Figure 4-6](#).



**FIGURE 4-6:** Numbering System Indicators.

## 4.2.2 Main Configuration Panel

The Main Configuration section, shown in [Figure 4-7](#), contains the PAC1921 configuration controls in registers 00h, 01h and 02h. Refer to the data sheet for register bit descriptions.

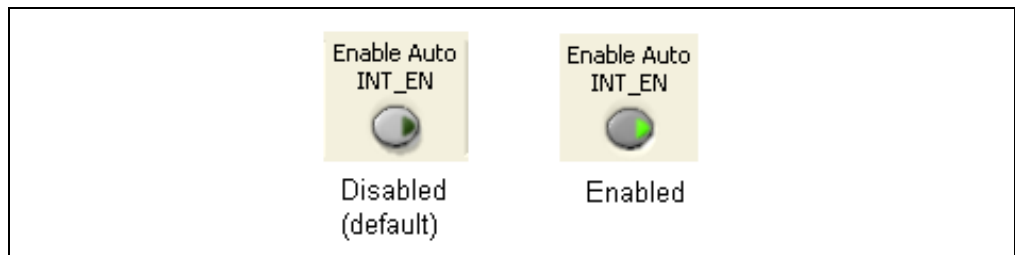


**FIGURE 4-7:** Main Configuration Panel.

### 4.2.2.1 ENABLE AUTO INT\_EN

The “Enable Auto INT\_EN” control is a GUI control convenience. Under normal operation, for most of the integration parameter settings, changes do not take effect until the PAC1921 is placed in the Read state. When the “Enable Auto INT\_EN” control is activated (light green – shown as “Enabled” in [Figure 4-8](#)), it automatically places the PAC1921 into the Read state and back to Integrate state whenever a Main Configuration control is changed. It also updates the GUI calculations. When the “Enable Auto INT\_EN” control is disabled (dark green), the user must place the device in the Read state before the “I\_RES”, “V\_RES”, “SAMPLES”, “VSENSE FILT\_EN” and “VBUS FILT\_EN” changes take effect, and to update the GUI calculations.

It is recommended that the “Enable Auto INT\_EN” control be activated when using the GUI.



**FIGURE 4-8:** Enable Auto INT\_EN GUI Control.

## 4.2.3 Overflow Status Panel

The Overflow Status section, shown in [Figure 4-9](#), represents the three bits in the Overflow Status Register 1Ch. When an indicator turns red, it indicates an overflow.

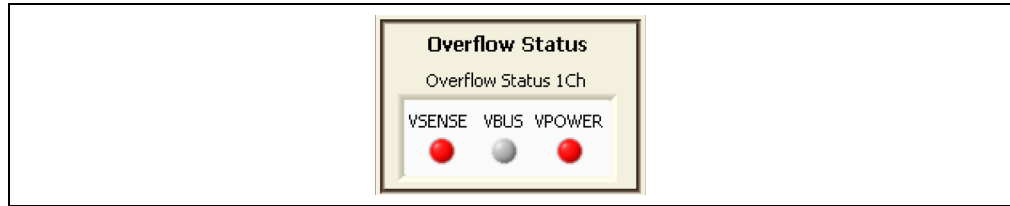


FIGURE 4-9: Overflow Status.

## 4.2.4 Rsense Panel

The Rsense section, shown in [Figure 4-10](#), needs to reflect the value of the  $R_{SENSE}$  resistor in use on the evaluation board. This value is used in calculations done by the GUI. In Demo mode, select the **1 Ohm - Demo** button. In Sys mode, select the **0.005 Ohm - System** button. If another resistor is used, check the **Custom** option button and fill the corresponding value in the spin box underneath the option.

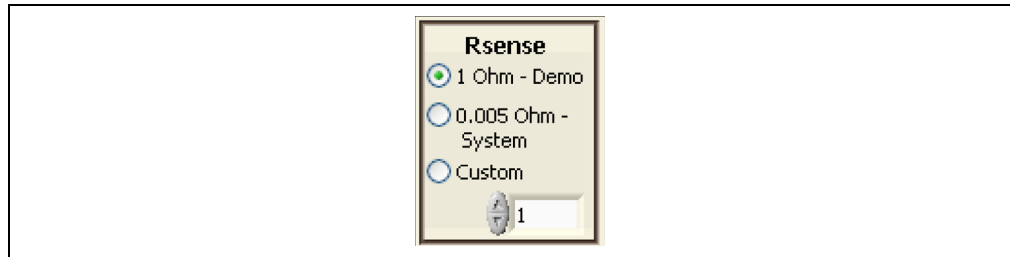


FIGURE 4-10: Rsense Configuration Panel.

## 4.2.5 Panel and Integration Control Panel

The Panel and Integration Control section, shown in [Figure 4-11](#), contains GUI controls which set and clear the INT\_EN bit. When using these controls, check the "READ/INT OVR" box in the Main Configuration section to allow the INT\_EN bit to override the READ/INT pin state.

**Note:** Read Period (ms) is always enabled.

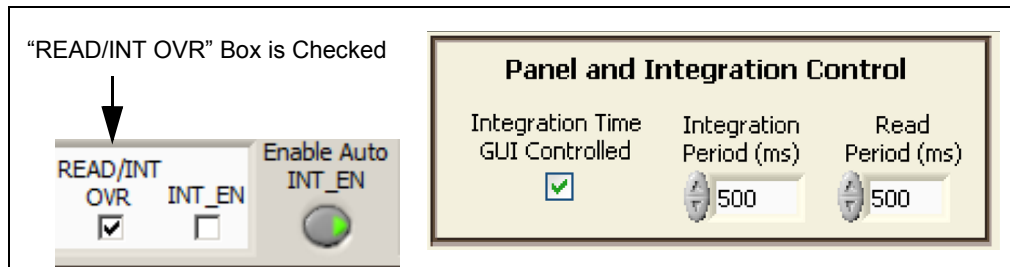
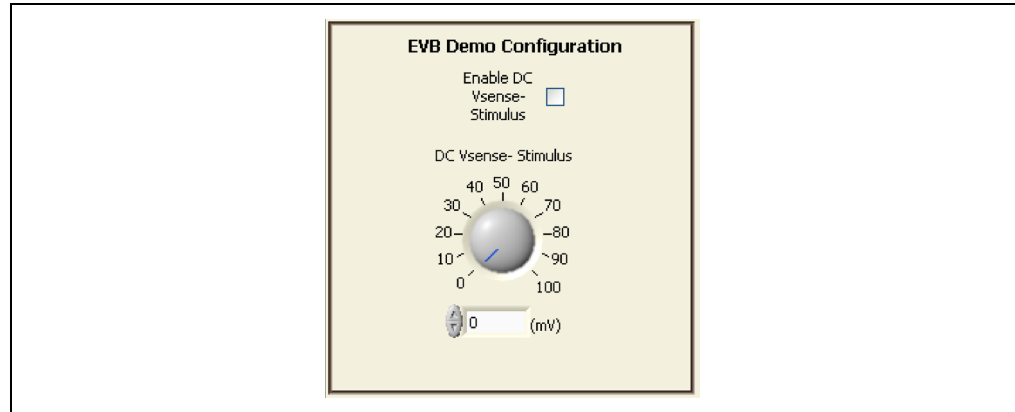


FIGURE 4-11: Panel and Integration Control.



#### 4.2.6 EVB Demo Configuration Panel

The EVB Demo Configuration panel, shown in [Figure 4-12](#), contains GUI controls which affect the Demo mode. To inject current onto  $V_{SENSE-}$ , check the “Enable DC Vsense- Stimulus” box. To set the current level, rotate the “DC Vsense- Stimulus” dial or type a value between 0 and 100 in the (mV) spin box below the dial.

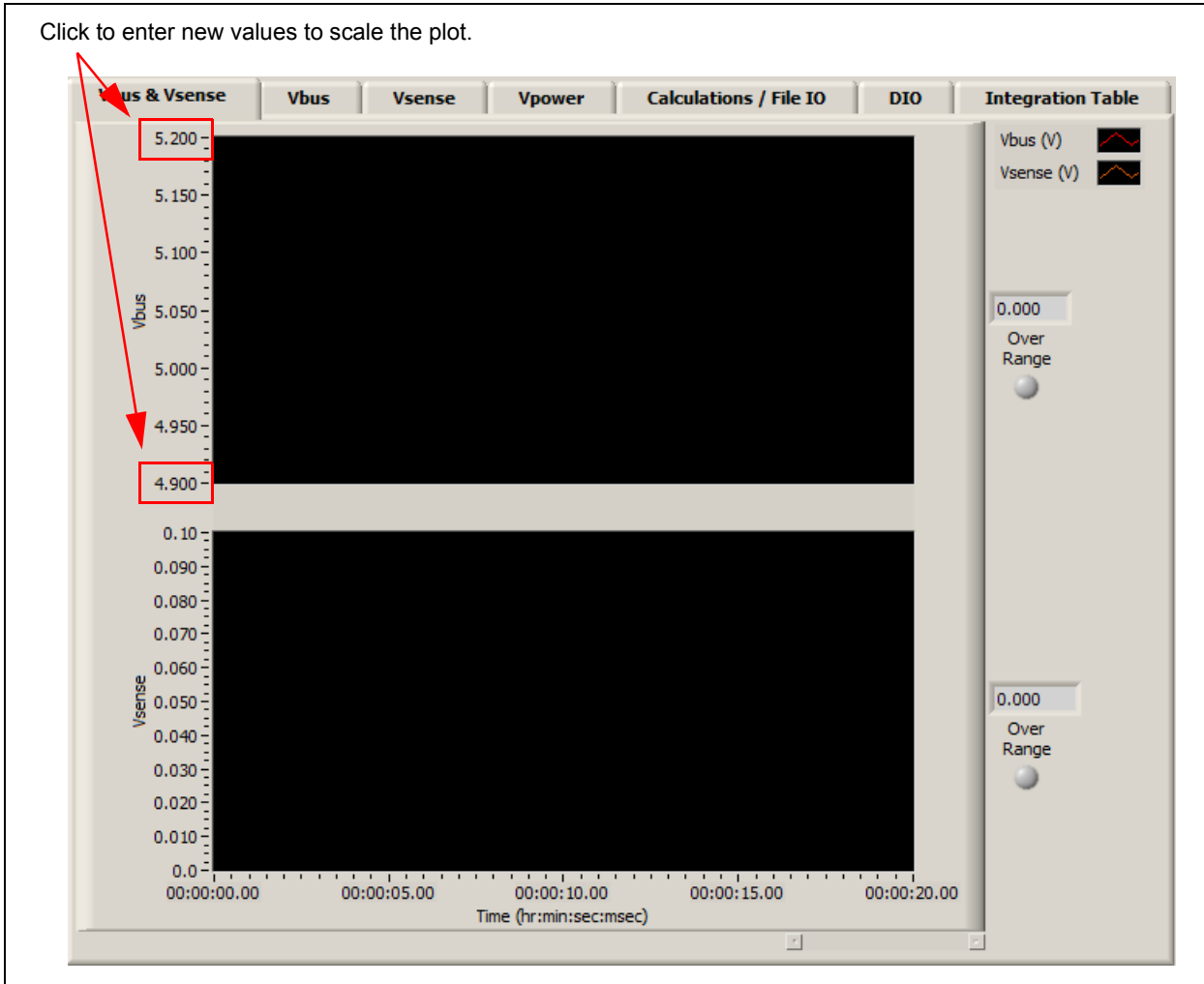


**FIGURE 4-12:** Evaluation Board Demo Configuration.

## 4.3 TAB DESCRIPTIONS

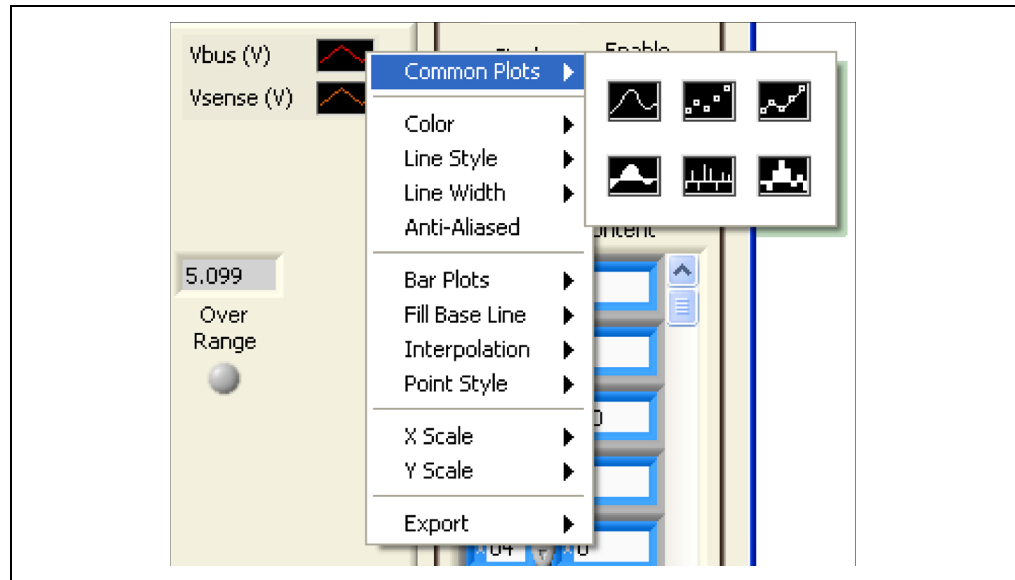
### 4.3.1 Vbus & Vsense Tab

The **Vbus & Vsense** tab, shown in [Figure 4-13](#), displays plots for calculated  $V_{BUS}$  in volts and calculated  $V_{SENSE}$  in volts. The plots are not self-scaling. If the value in the box at the right of the plot (indicated with arrows) falls outside the Y-axis range on the plot, click the top and/or bottom value on the axis and type in a new value.



**FIGURE 4-13:** Vbus & Vsense Tab.

To change the look of the plot lines, click the applicable graphic in the legend on the right of the tab to display a menu of options, as shown in [Figure 4-14](#).



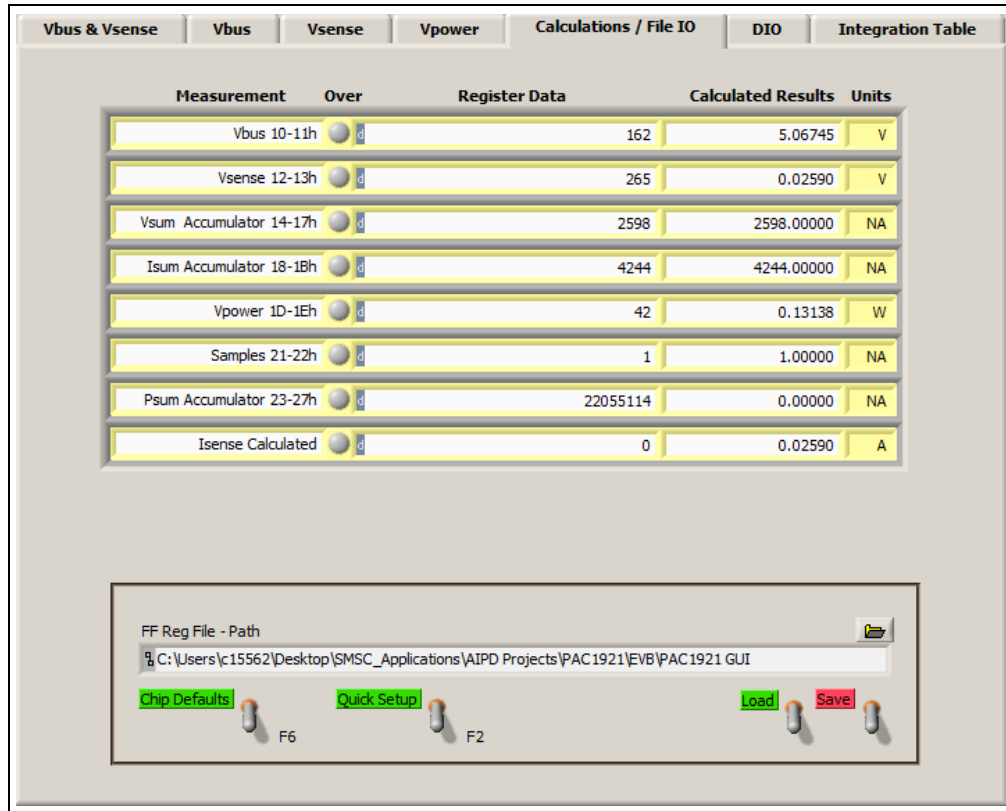
**FIGURE 4-14:** Plot Legend Context Menu.

### 4.3.2 Vbus, Vsense and Vpower Tabs

There are separate tabs to show individual plots for **Vbus**, **Vsense** and **Vpower**. They operate similarly to the **Vbus & Vsense** tab described above.

## 4.3.3 Calculations/File IO Tab

The **Calculations/File IO** tab, shown in [Figure 4-15](#), displays register data (in decimal by default). It also shows calculated results which were obtained by applying the data sheet equations to the register data.



**FIGURE 4-15:** Calculations/File IO Tab.

An example of using the equations to calculate power is as follows.

The value of one LSB in the  $V_{POWER}$  Result registers, in watts, can be calculated according to [Equation 4-1](#).

### EQUATION 4-1: LSB CALCULATION

$$1LSB = \frac{0.1V}{R\Omega \times DI\_GAIN} \times \frac{32V}{1023 \times 2^6 \times DV\_GAIN}$$

Where:

- 1LSB = LSB value in watts for  $V_{POWER}$  Result Registers 1Dh and 1Eh
- 0.1V = Maximum  $V_{SENSE}$  voltage
- R = Value of  $R_{SENSE}$  resistor in ohms
- DI\_GAIN = Digital current gain
- 32V/DV\_GAIN = Maximum voltage
- 1023 =  $(2^{10} - 1)$  = 10-bit FSR
- $2^6$  = Adjustment for 6 unused register bits when read as a 16-bit number

The power calculation using the  $V_{\text{POWER}}$  Result registers value from Figure 4-15 is shown in Equation 4-2.

## EQUATION 4-2: POWER CALCULATION

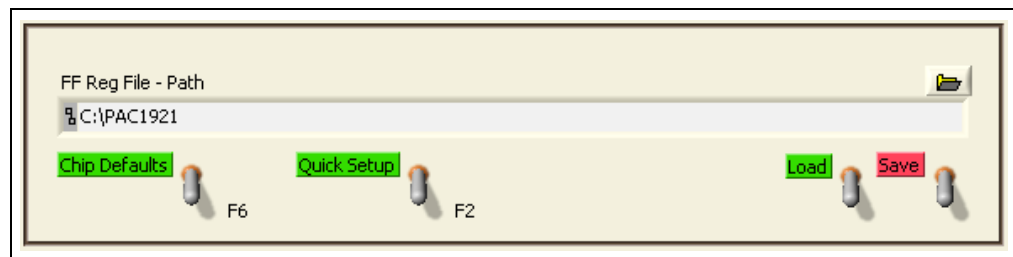
$$\frac{0.1V}{1\Omega \times 1} \times \frac{32V}{1} \times (42) = 0.13138W$$

Where:

- 0.1V = Maximum  $V_{\text{SENSE}}$  voltage
- 1 $\Omega$  = Value of  $R_{\text{SENSE}}$  resistor
- 1 = Digital current gain
- 32V/1 = Maximum voltage
- 1023 = 10-bit FSR
- 42 = Decimal value of  $V_{\text{POWER}}$  Result Registers 1Dh and 1Eh

### 4.3.3.1 CONFIGURATION SAVE AND LOAD

The **Calculations/File IO** tab contains controls, as shown in Figure 4-16, which save the settings currently configured in the PAC1921 to allow quick reconfiguration at any time.



**FIGURE 4-16:** Save/Load Section.

To save configuration settings, configure the PAC1921 as desired, then display the **Calculations/File IO** tab. The “FF Reg File Path” box defaults to where the GUI software is installed. To change the location, type in a path, or click the folder icon to use a Windows® system-based navigation aid to select the folder where the configuration file will be saved. The file should be named with the .txt extension or similar text file format. Once a file name and location have been chosen, click the **Save** switch, and the file is saved.

**Note:** If a file with the same name already exists, the file will be overwritten without warning and old data will be lost.

The data is saved in two columns, separated by tabs. The first column is the register address and the second column is the register data.

Once a file is saved, it can be recalled at any time by selecting the file in the “FF Reg File Path” box and clicking the **Load** switch.

Click the **Chip Defaults** switch or press the <F6> function key on the keyboard to reload register defaults on the PAC1921.

Click the **Quick Setup** switch or press the <F2> function key on the keyboard to set up the GUI and PAC1921 for free-run integration power measurement. The **Quick Setup** switch does the following:

- Enables the "Enable Auto INT\_EN" option.
- Enables the "READ/INT OVR" option.
- Enables the "INT\_EN" option.
- Sets "MUX\_SEL" to VPOWER free-run.
- Enables the "Enable DC Vsense- Stimulus" option.

### 4.3.4 Integration Table Tab

The **Integration Table** tab, shown in [Figure 4-17](#), shows the maximum integration periods for a selected number of samples with various settings.

Vbus & Vsense		Vbus	Vsense	Vpower	Calculations / File IO	DIO	Integration Table
SAMPLES	INTEGRATION PERIOD POWER MEASUREMENT			INTEGRATION PERIOD VSENSE OR VBUS MEASUREMENT			
	14-BIT ADC RESOLUTION POST FILTERS ON	11-BIT ADC RESOLUTION POST FILTERS OFF	MIXED ADC RESOLUTION POST FILTERS ON	14-BIT ADC RESOLUTION POST FILTERS ON	11-BIT ADC RESOLUTION POST FILTERS OFF		
1	2.72ms	0.93ms	2.1ms	1.41ms	0.51ms		
2	4.05ms	1.46ms	3.1ms	2.02ms	0.72ms		
4	6.79ms	2.41ms	5.1ms	3.43ms	1.24ms		
8	12.2ms	4.32ms	9.2ms	6.06ms	2.08ms		
16	23ms	8.05ms	17.5ms	11.5ms	3.95ms		
32	46ms	16.1ms	34.9ms	22.9ms	7.89ms		
64	92ms	32.1ms	70ms	45.7ms	15.7ms		
128	184ms	64.2ms	139ms	91.3ms	31.4ms		
256	368ms	128.3ms	278ms	183ms	62.7ms		
512	736ms	257ms	556ms	365ms	126ms		
1024	1471ms	513ms	1112ms	730ms	251ms		
2048	2941ms	1026ms	2223ms	1460ms	502ms		

**FIGURE 4-17:** Integration Table Tab.

## 4.4 EVALUATION BOARD EXAMPLES

### 4.4.1 Power Pin-Controlled Integration Example

This example provides steps to experiment with pin-controlled integration in SMBus mode and see the effects of gain.

1. In the Main Configuration section, check the “READ/INT OVR” box. This allows the INT\_EN bit to override the READ/INT pin state. Also check the “Enable Auto INT\_EN” control to set automatic GUI updates.
2. In the Panel and Integration Control section, check the “Integration Time GUI Controlled” box, and set the “Read Period (ms)” to 500 ms. This causes the INT\_EN bit to toggle between high for 500 ms (putting the PAC1921 in the Integrate state) and low for 500 ms (putting the device in the Read state).
3. In the EVB Demo Configuration section, check the “Enable DC Vsense-Stimulus” box and type 40 mV in the “DC Vsense- Stimulus (mV)” box.
4. Observe the plots on the **Vbus & Vsense** tab, as shown in [Figure 4-18](#). The evaluation board demo V<sub>BUS</sub> is ~5.1V and V<sub>SENSE</sub> is ~0.04V.

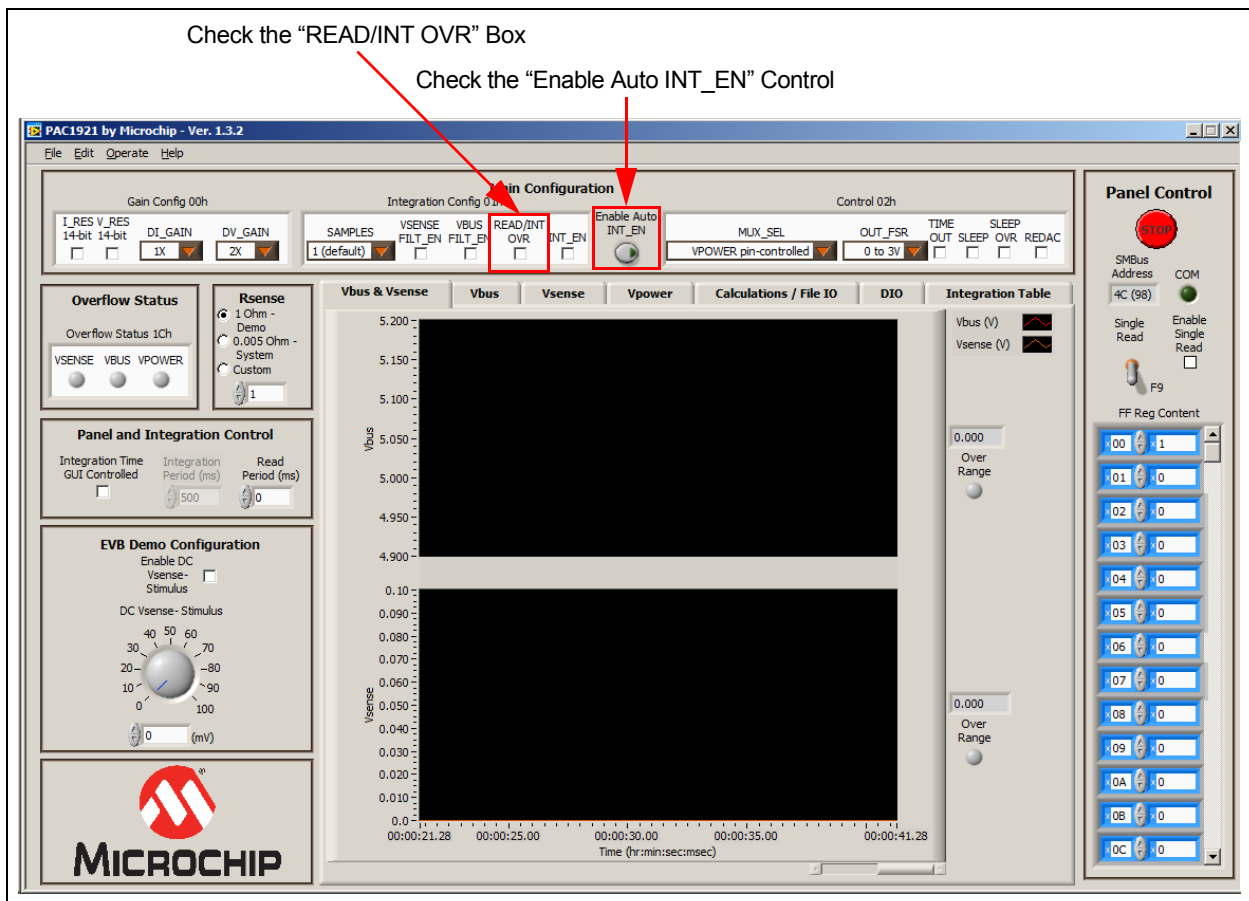


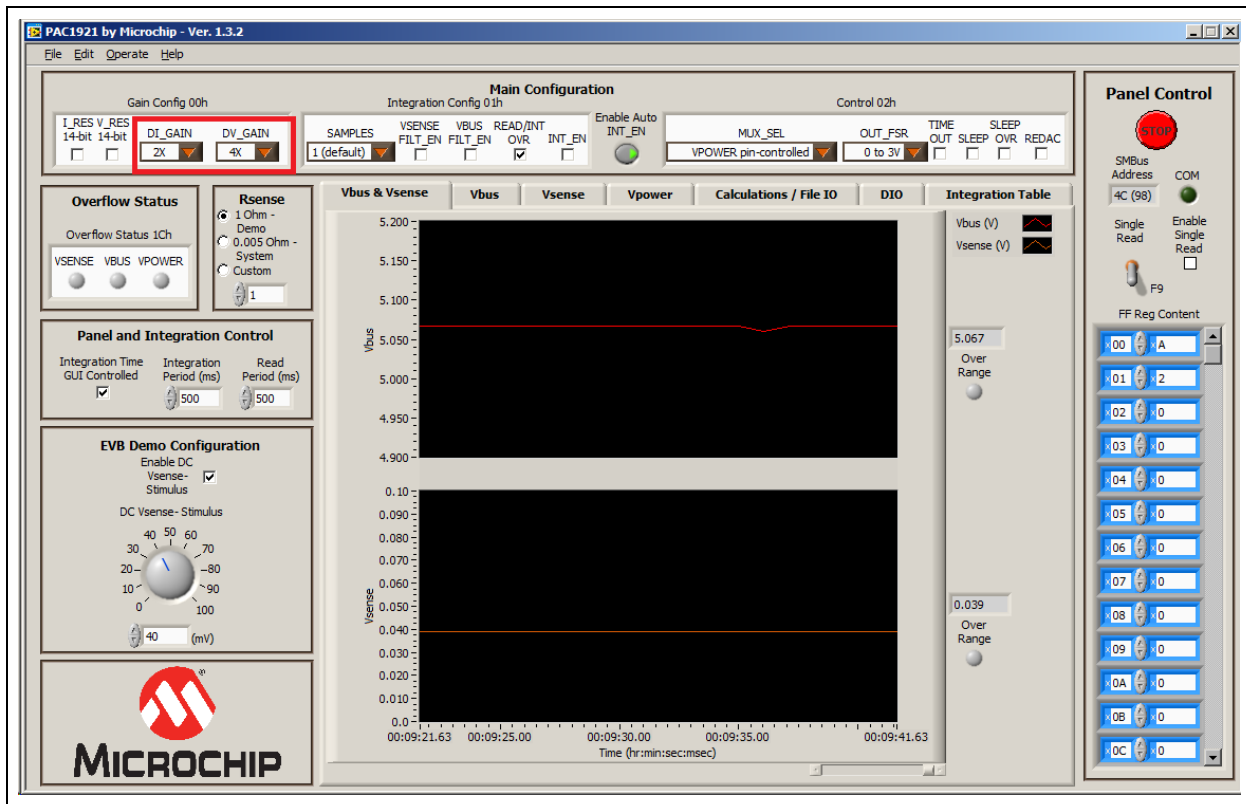
FIGURE 4-18: Pin-Controlled Integration, No Gain.

- Observe the data on the **Calculations/File IO** tab, as shown in [Figure 4-19](#).

Measurement	Over	Register Data	Calculated Results	Units
Vbus 10-11h	<input type="radio"/>	162	5.06745	V
Vsense 12-13h	<input type="radio"/>	396	0.03871	V
Vsum Accumulator 14-17h	<input type="radio"/>	1461625	1461625.00000	NA
Isum Accumulator 18-1Bh	<input type="radio"/>	3574075	3574075.00000	NA
Vpower 1D-1Eh	<input type="radio"/>	63	0.19707	W
Samples 21-22h	<input type="radio"/>	564	564.00000	NA
Psum Accumulator 23-27h	<input type="radio"/>	18524669968	0.00000	NA
Isense Calculated	<input type="radio"/>	0	0.03871	A

**FIGURE 4-19:** Pin-Controlled Integration without Gain.

- To see the effects of gain, change “DI\_GAIN” to 2X and “DV\_GAIN” to 4X in the Gain Config 00h section, as shown in [Figure 4-20](#).



**FIGURE 4-20:** Pin-Controlled Integration with Gain.



- Observe the data on the **Calculations/File IO** tab, as shown in [Figure 4-21](#). Notice that the Register Data values (with the exception of the accumulators) reflect the gain.

Measurement	Over	Register Data	Calculated Results	Units
Vbus 10-11h	<input type="radio"/>	648	5.06745	V
Vsense 12-13h	<input type="radio"/>	794	0.03881	V
Vsum Accumulator 14-17h	<input type="radio"/>	1461220	1461220.00000	NA
Isum Accumulator 18-1Bh	<input type="radio"/>	3581976	3581976.00000	NA
Vpower 1D-1Eh	<input type="radio"/>	502	0.19629	W
Samples 21-22h	<input type="radio"/>	564	564.00000	NA
Psum Accumulator 23-27h	<input type="radio"/>	18560477924	0.00000	NA
Isense Calculated	<input type="radio"/>	0	0.03881	A

**FIGURE 4-21:** Pin-Controlled Integration with Gain.

## 4.4.2 Power Free-Run Integration Example

This section provides steps to experiment with free-run integration in SMBus mode and see the effects of filtering, resolution and sampling. It starts by showing the fastest integration period and progressively shows higher accuracy.

1. Press the <F2> function key on the keyboard. This performs Quick Setup, which checks the “READ/INT OVR” box, the “INT\_EN” bit box and the “Enable DC Vsense- Stimulus” box, enables the “Enable Auto INT\_EN” control and sets “MUX\_SEL” to VPOWER free-run. Integration begins using the 1 sample default.
2. In the Main Configuration section, click the “I\_RES” and “V\_RES” boxes so 11-bit shows; this lowers the resolution from 14 bits to 11 bits.
3. In the Main Configuration section, uncheck the “VSENSE FILT\_EN” and “VBUS FILT\_EN” boxes to disable the ADC post filters.
4. In the EVB Demo Configuration section, type 40 mV in the “DC Vsense-Stimulus” spin box.
5. Observe the plots on the **Vbus & Vsense** tab, as shown in [Figure 4-22](#), adjusting the Y-axis values as desired. These settings result in the shortest integration period.

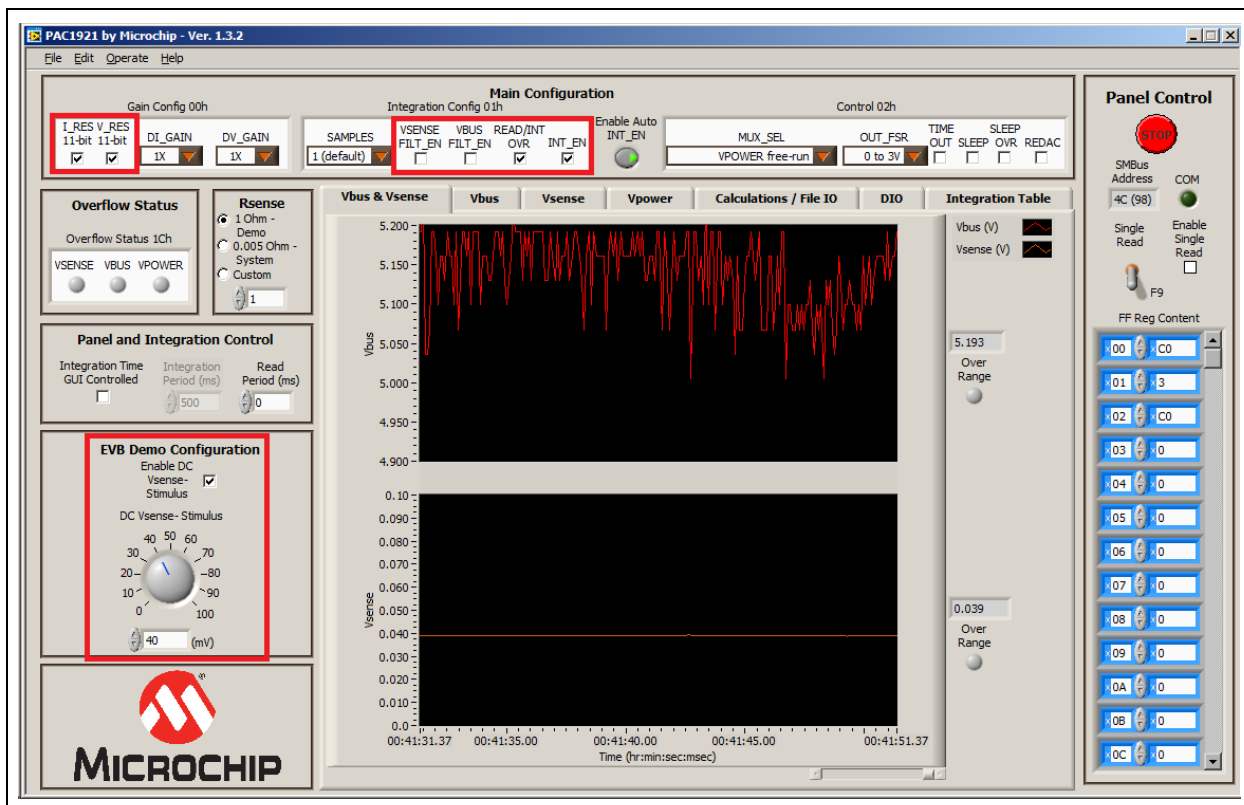
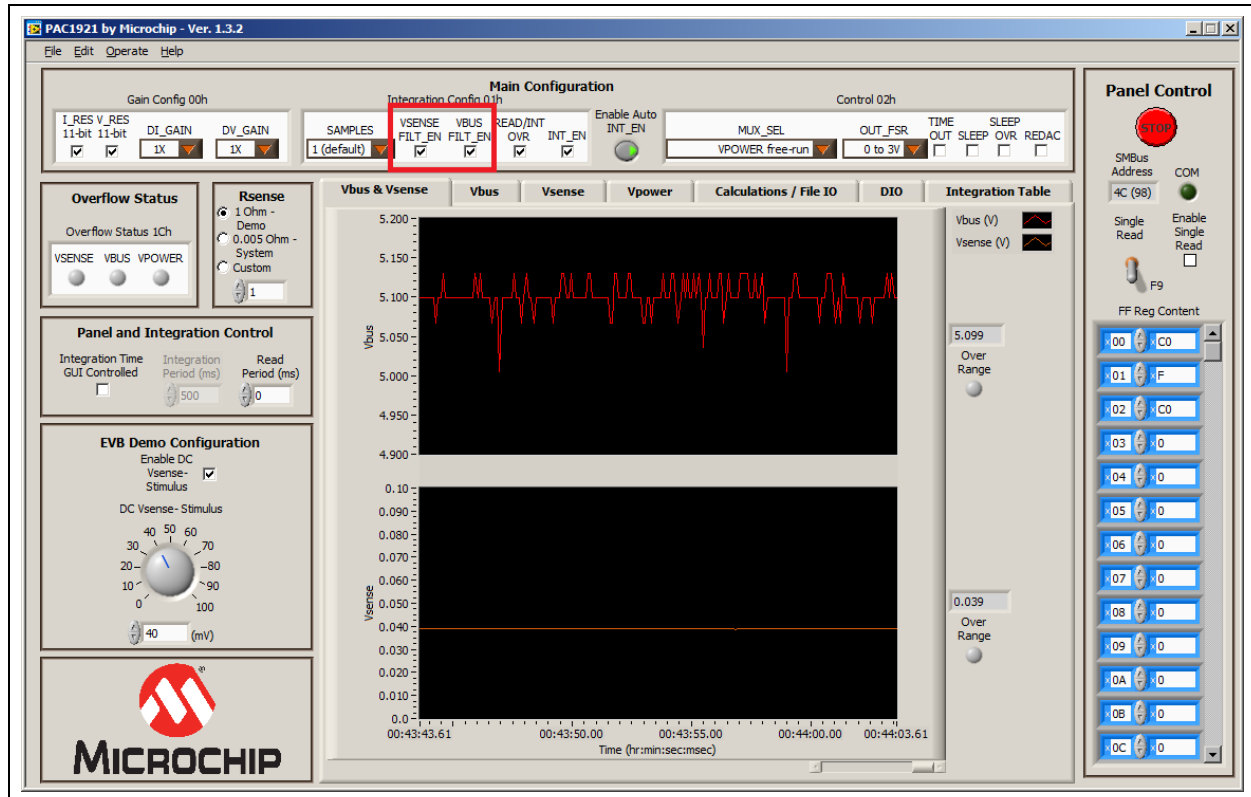


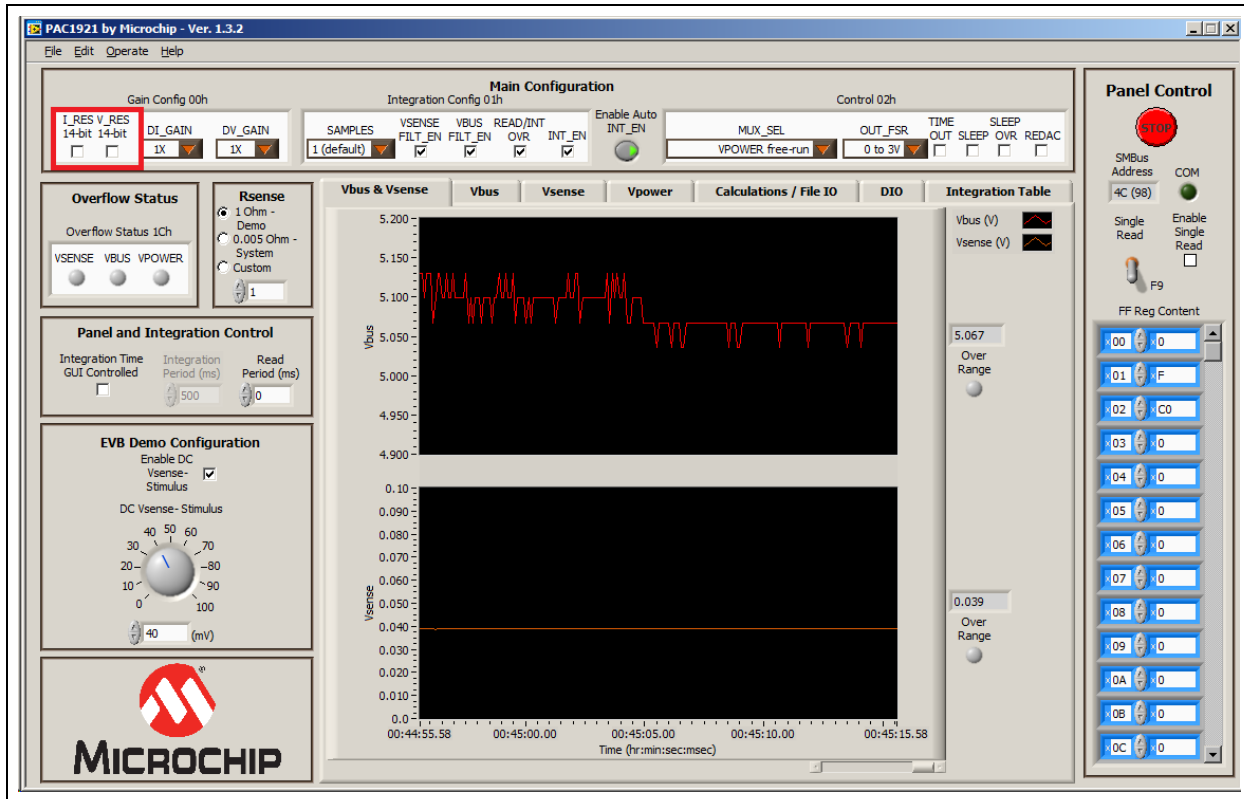
FIGURE 4-22: Free-Run Integration, Shortest Period.

- Check the “VSENSE FILT\_EN” and “VBUS FILT\_EN” boxes to enable the ADC post filters, and observe the improvement in the plots on the **Vbus & Vsense** tab, as shown in [Figure 4-23](#).



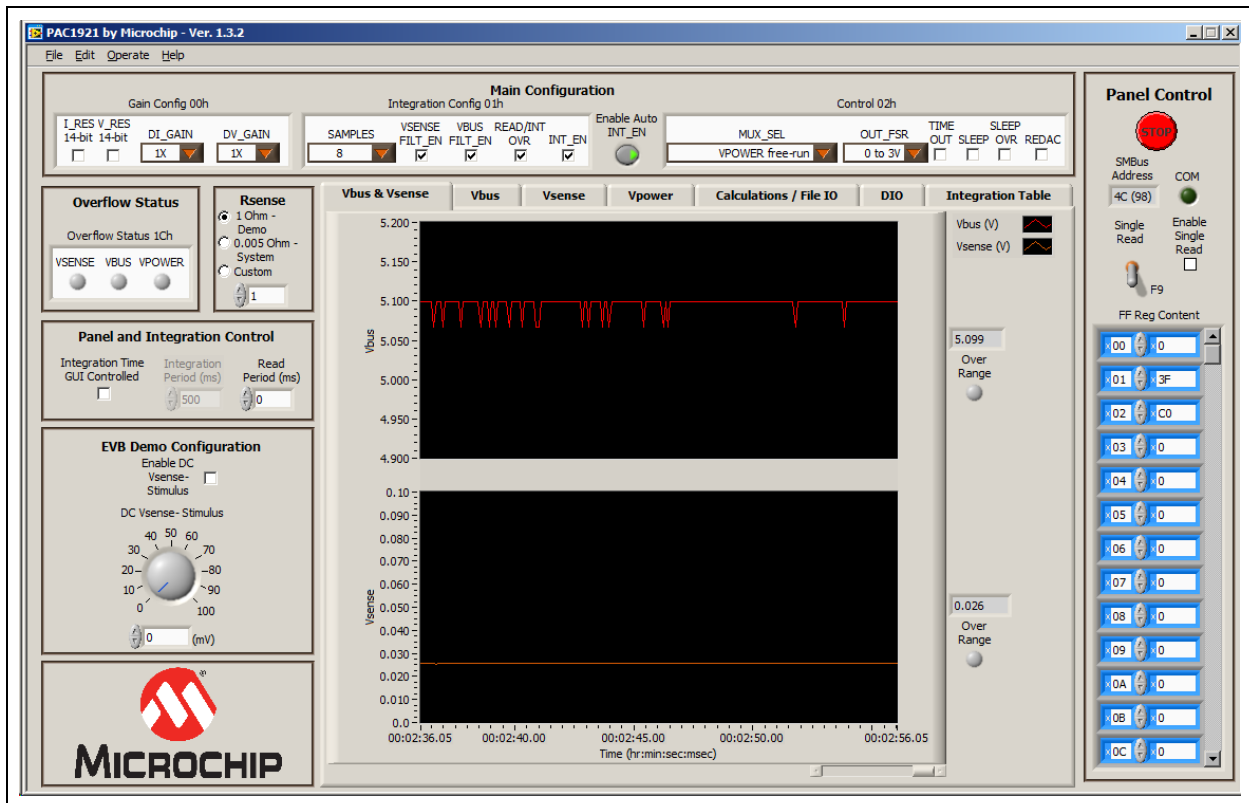
**FIGURE 4-23:** Free-Run Integration with ADC Post Filters Enabled.

7. Uncheck the "I\_RES" and "V\_RES" boxes to enable 14-bit resolution, and observe the improvement in the plots on the **Vbus & Vsense** tab, as shown in Figure 4-24.



**FIGURE 4-24:** Free-Run Integration with 14-Bit Resolution.

8. Change the number of “SAMPLES” to 8 and observe the improvement in the plots on the **Vbus & Vsense** tab, as shown in [Figure 4-25](#).



**FIGURE 4-25:** Increased Sample Effect.

## 4.5 TROUBLESHOOTING

### 4.5.1 GUI Controls Unresponsive After Installation

Restart the computer. In some cases, a restart is required after installation.

### 4.5.2 GUI Freezes

If the GUI freezes for unknown reasons, communications cannot be stopped and the program cannot be closed. Disconnect the USB cable from the evaluation board, then close the program. Reconnect the evaluation board, then restart the GUI.

NOTES:

---

---

## Appendix A. Schematic and Layouts

---

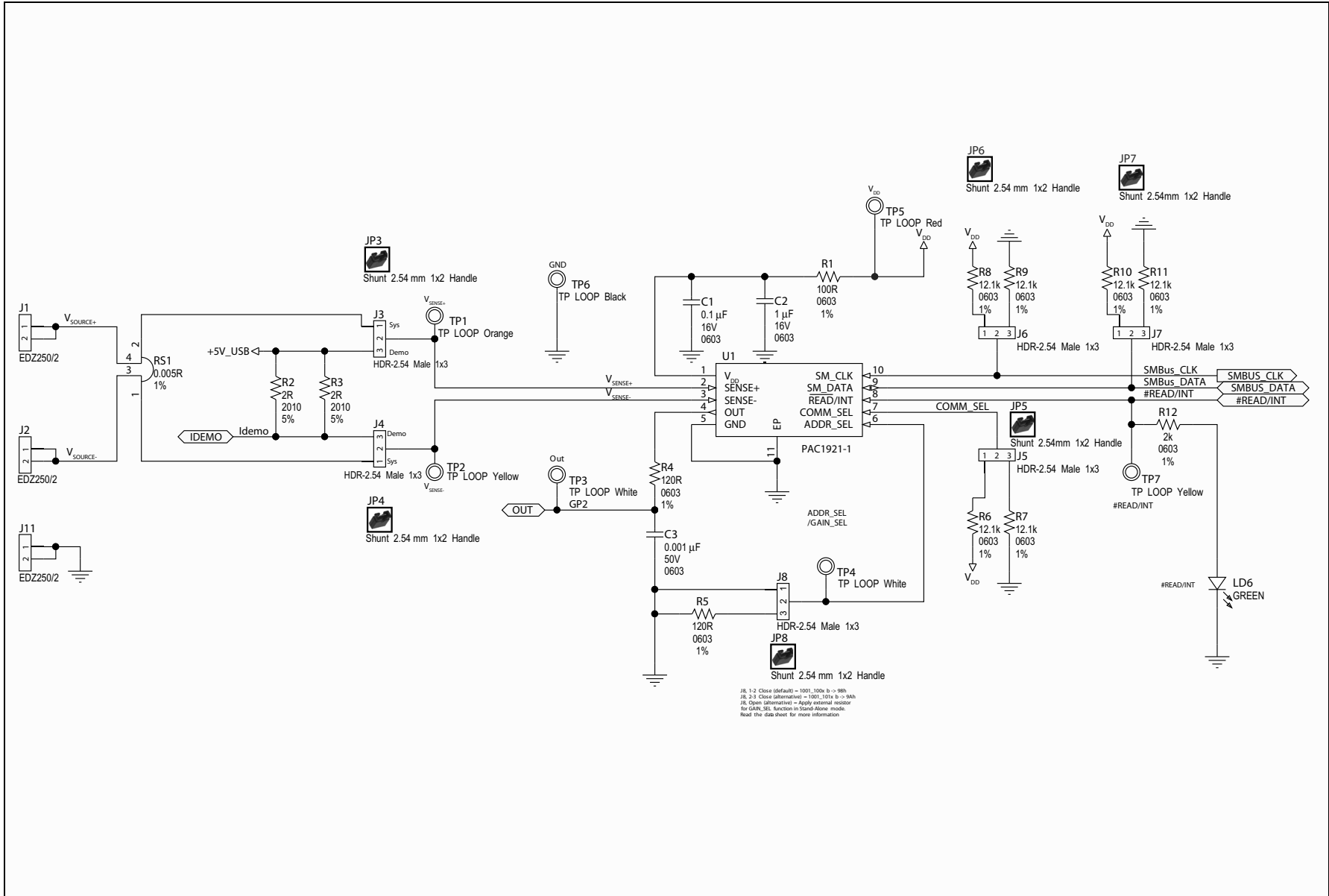
---

### A.1 INTRODUCTION

This appendix contains the following schematics and layouts for the PAC1921 High-Side Current/Power Sensor Evaluation Board:

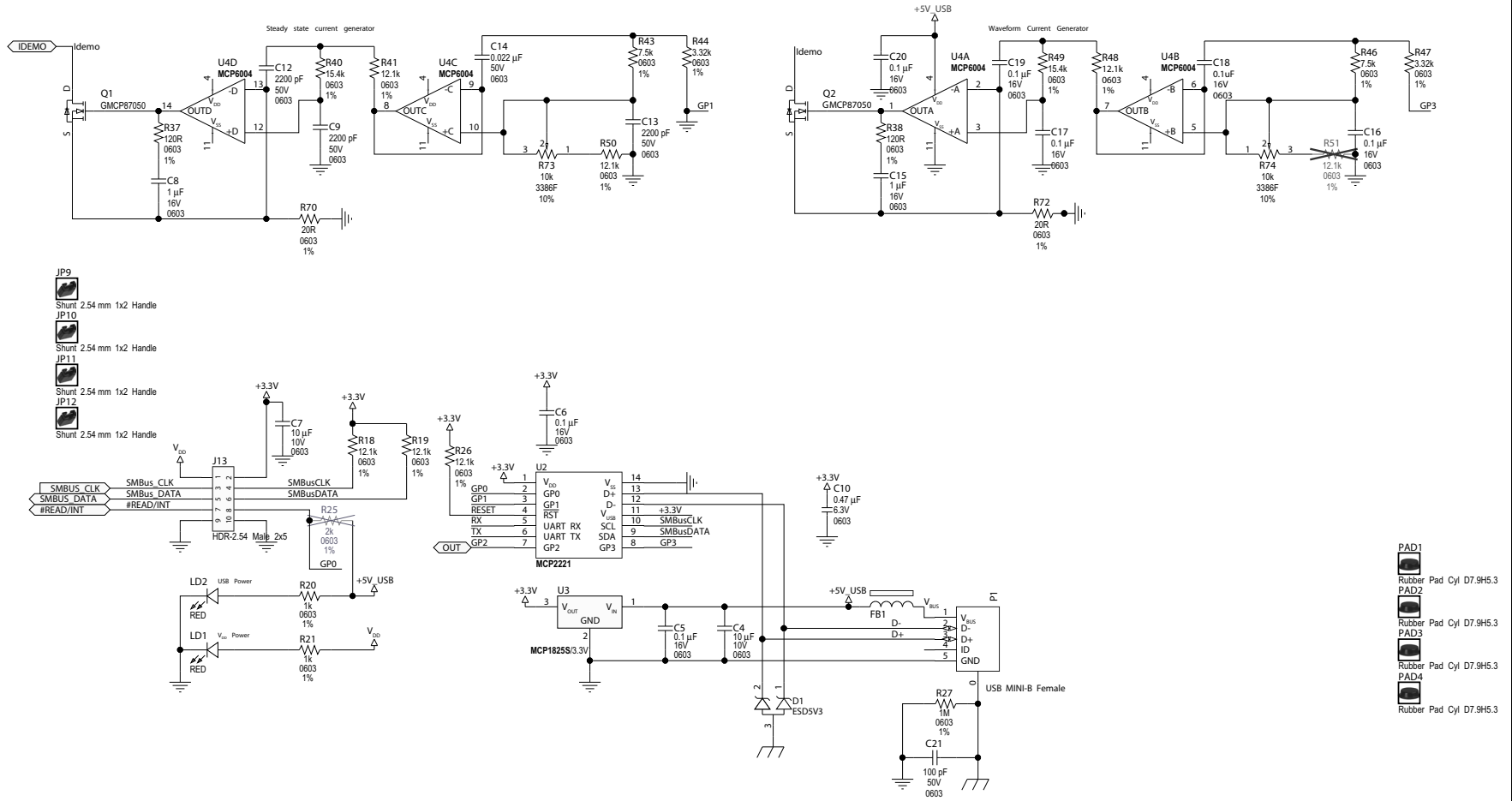
- [Board – PAC1921 Current Shunt and Power Monitor Schematic](#)
- [Board – USB Bridge and Sig Gen Schematic](#)
- [Board – Top Silk](#)
- [Board – Top Copper and Silk](#)
- [Board – Top Copper](#)
- [Board – Bottom Copper](#)
- [Board – Bottom Copper and Silk](#)
- [Board – Bottom Silk](#)

# A.2 BOARD – PAC1921 CURRENT SHUNT AND POWER MONITOR SCHEMATIC

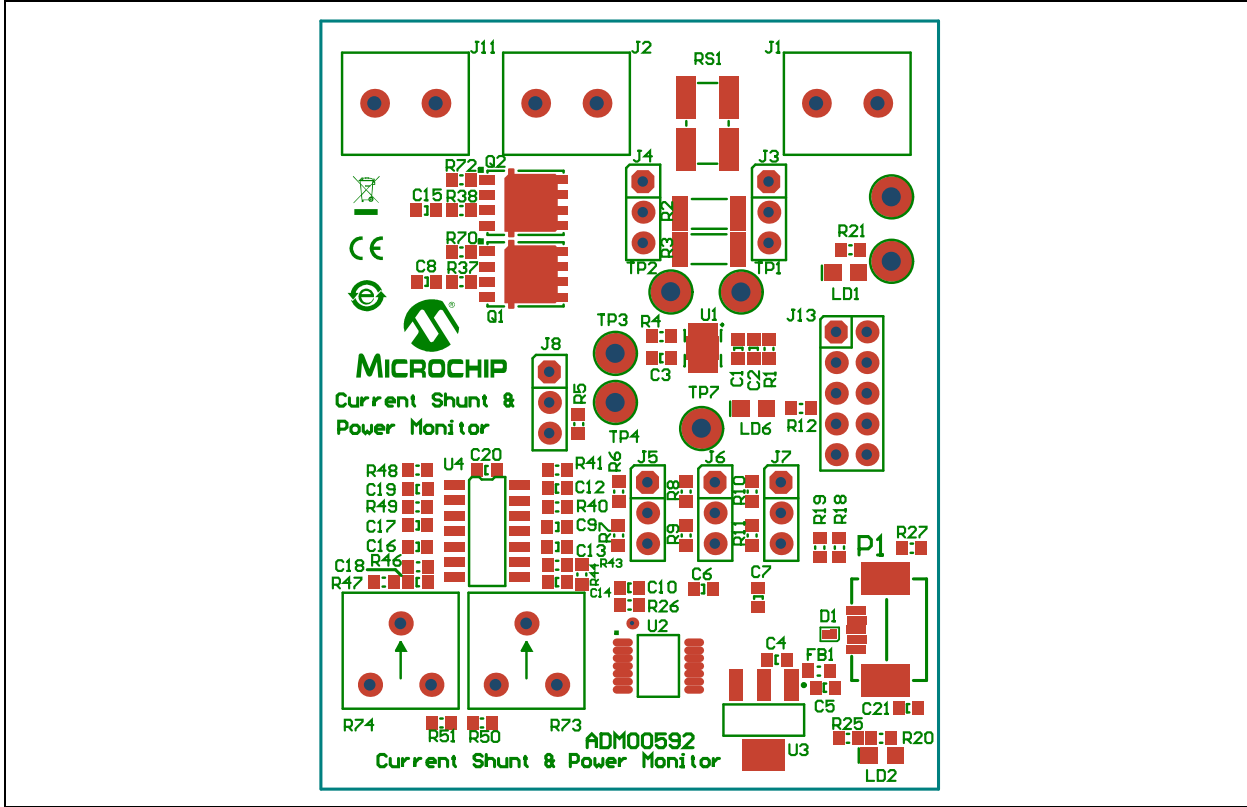




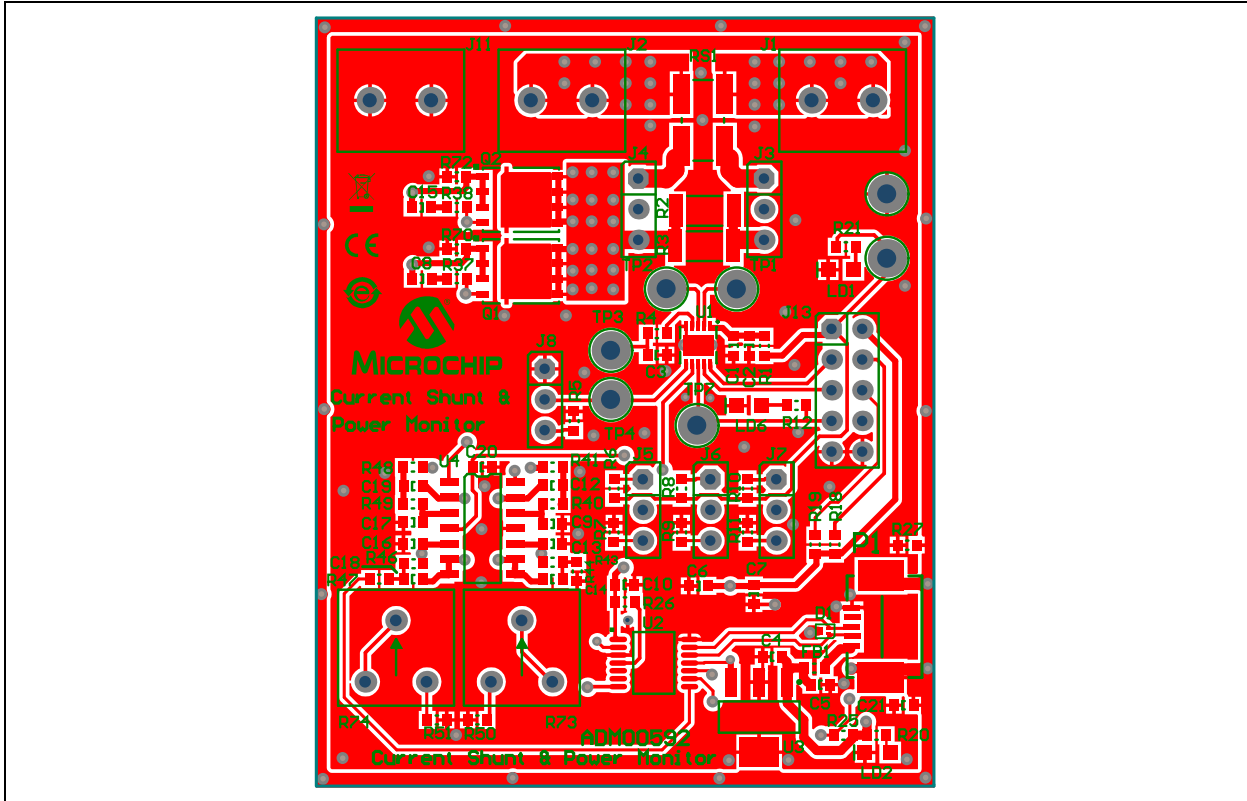
### A.3 BOARD – USB BRIDGE AND SIG GEN SCHEMATIC



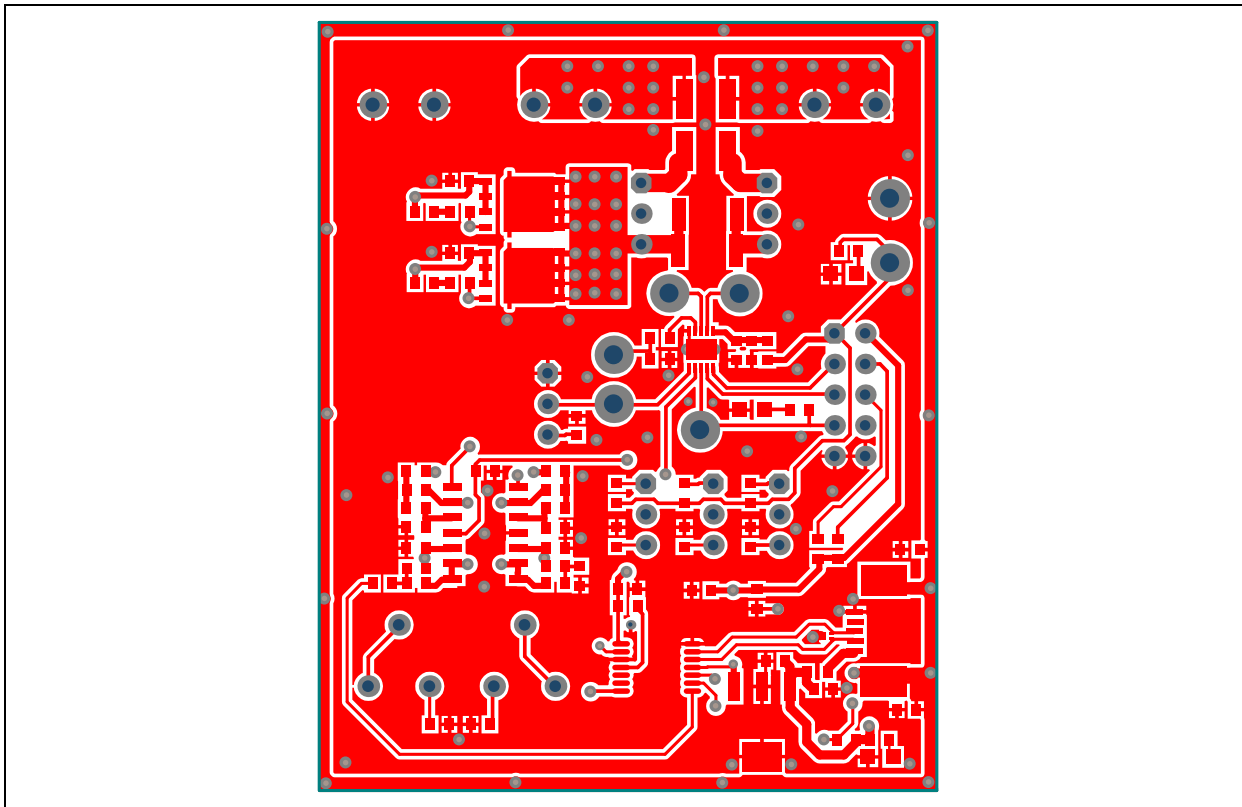
## A.4 BOARD – TOP SILK



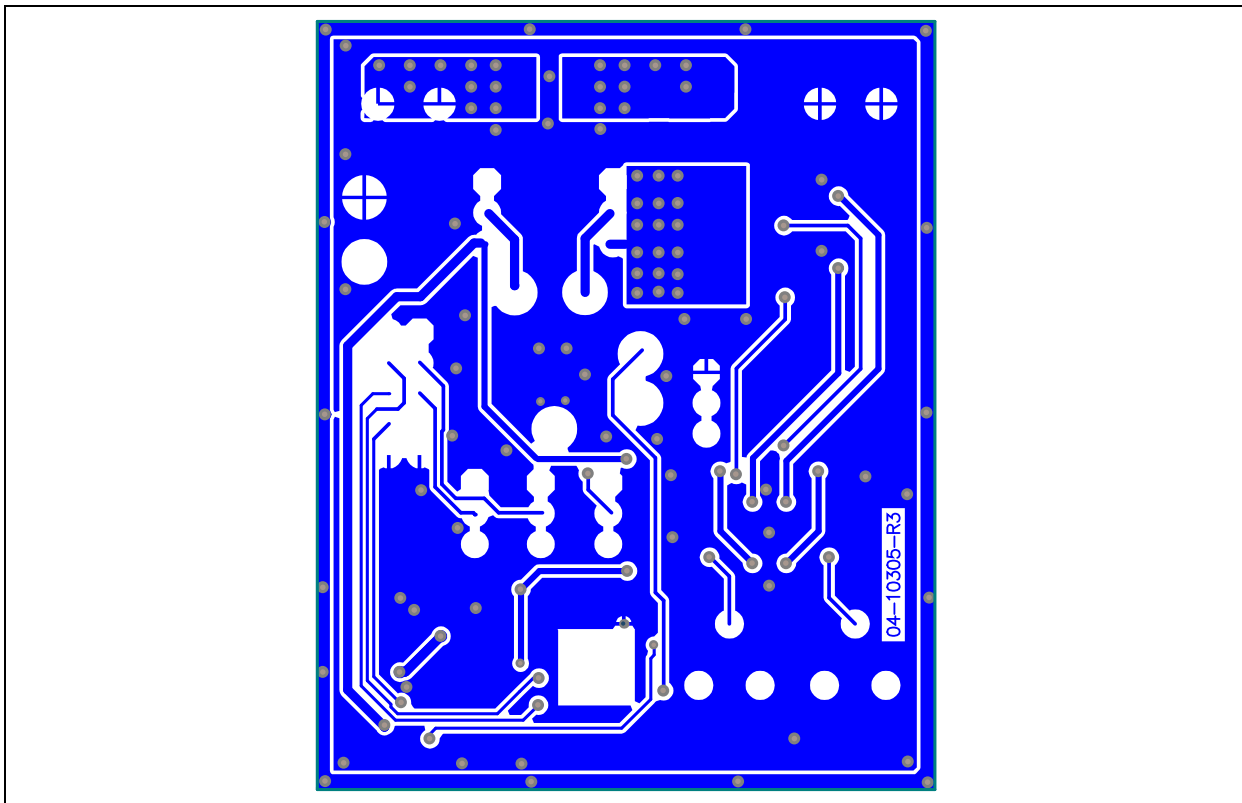
## A.5 BOARD – TOP COPPER AND SILK



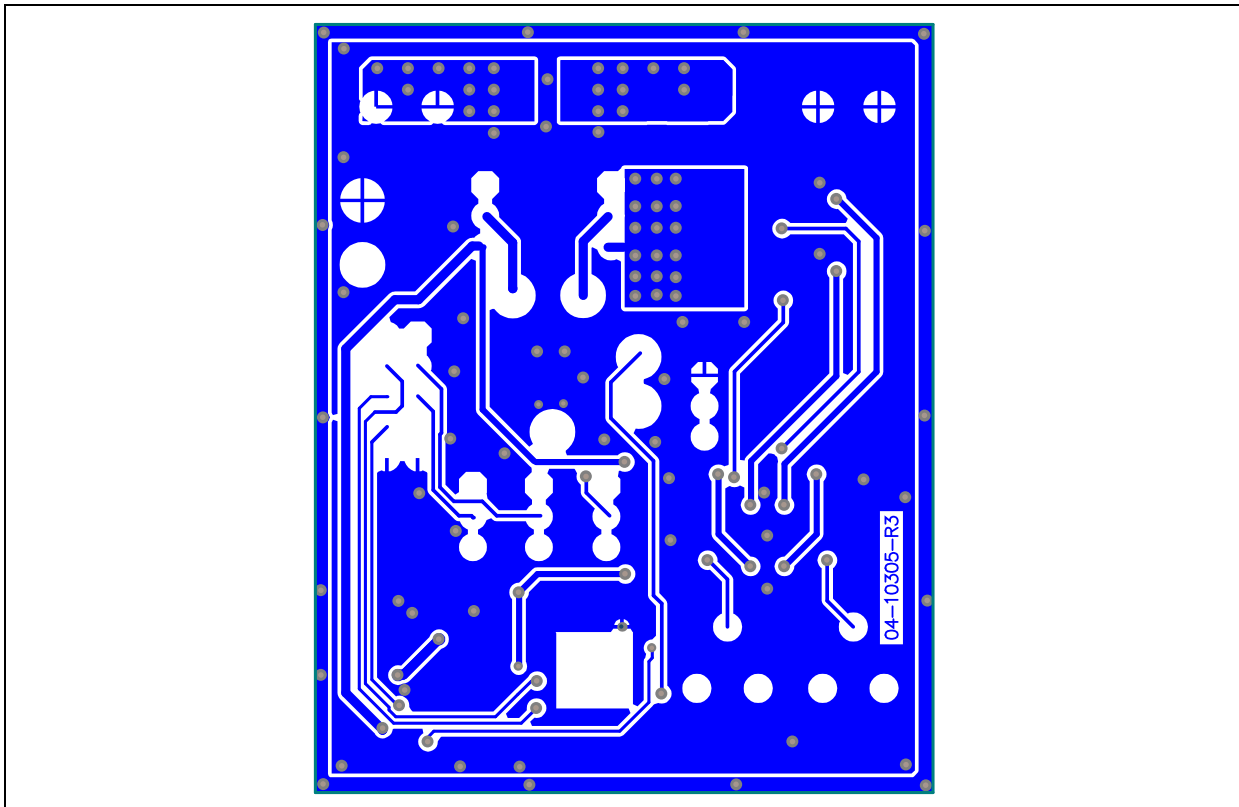
A.6 BOARD – TOP COPPER



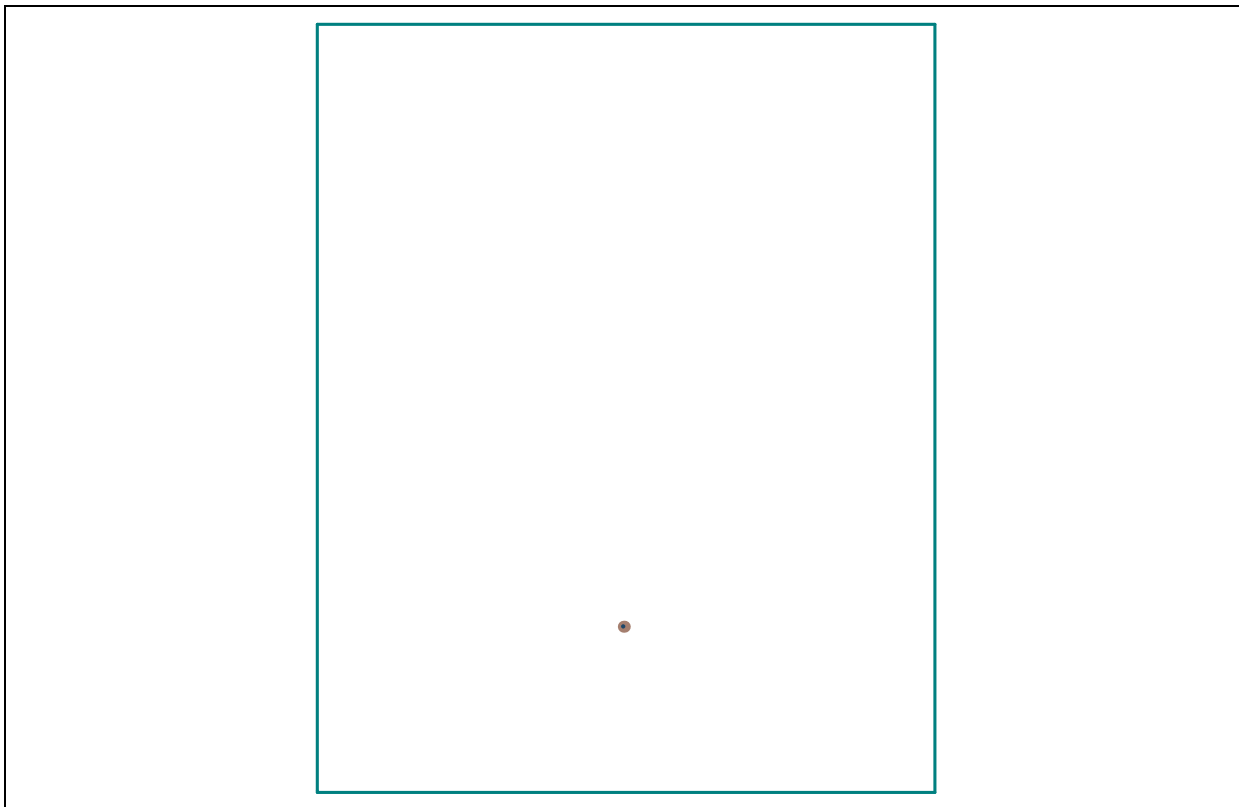
A.7 BOARD – BOTTOM COPPER



**A.8 BOARD – BOTTOM COPPER AND SILK**



**A.9 BOARD – BOTTOM SILK**



**Appendix B. Bill of Materials (BOM)**

**TABLE B-1: BILL OF MATERIALS (BOM)<sup>(1)</sup>**

Qty	Reference	Description	Manufacturer	Part Number
8	C1, C5, C6, C16, C17, C18, C19, C20	Cap. Ceramic, 0.1 $\mu$ F, 16V, 10%, X7R, SMD, 0603	NIC Components Corp.	NMC0603X7R104K16TRPF
1	C10	Cap. Ceramic, 0.47 $\mu$ F, 6.3V, 10%, X5R, SMD, 0603	Murata Electronics®	GRM188R60J474KA01D
1	C14	Cap. Ceramic, 0.022 $\mu$ F, 50V, 10%, X7R, SMD, 0603	TDK Corporation	C1608X7R1H223K
3	C2, C8, C15	Cap. Ceramic, 1 $\mu$ F, 16V, 10%, X7R, SMD, 0603	Taiyo Yuden Co., Ltd.	EMK107B7105KA-T
1	C21	Cap. Ceramic, 100 pF, 50V, 1%, C0G, SMD, 0603	TDK Corporation	C1608C0G1H101F
1	C3	Cap. Ceramic, 0.001 $\mu$ F, 50V, 20%, X7R, SMD, 0603	KEMET™	C0603C102M5RAC
2	C4, C7	Cap. Ceramic, 10 $\mu$ F, 10V, 20%, X5R, SMD, 0603	Panasonic®	ECJ-1VB1A106M
3	C9, C12, C13	Cap. Ceramic, 2200 pF, 50V, 10%, X7R, SMD, 0603	KEMET	C0603C222K5RACTU
1	D1	DIO TVSARR, ESD5V3U2U, 5.3V, SMD, SOT-883	Infineon Technologies	ESD5V3U2U-03LRH E6327
1	FB1	Ferrite, 500 mA, 0.1R, SMD, 0603	Laird-Signal Integrity	LI0603E470R-10
3	J1, J2, J11	Conn. Terminal, 5.08 mm, 15A, Female, 1x2, TH R/A	On Shore Technology Inc.	EDZ250/2
1	J13	Conn. HDR-2.54, Male, 2x5, 0.100" (2.54 mm), TH Vert.	Samtec, Inc.	TSW-105-07-G-D
6	J3, J4, J5, J6, J7, J8	Conn. HDR-2.54, Male, 1x3, Tin, 5.84 MH, TH Vert.	Samtec, Inc.	TSW-103-07-T-S
10	JP3, JP4, JP5, JP6, JP7, JP8, JP9, JP10, JP11, JP12	Mech. HW Jumper, 2.54 mm, 1x2, Handle Gold	TE Connectivity, Ltd.	881545-2
2	LD1, LD2	DIO LED Red, 1.95V, 20 mA, 220 mcd, Clear, SMD, 0805	Kingbright Corp.	APT2012SURCK
1	LD6	DIO LED Green, 2V, 30 mA, 120 mcd, Diffuse, SMD, 0805	Avago Technologies US Inc.	HSMM-C170
1	P1	Conn. USB Mini-B Female, SMD, R/A	Hirose Electric Co., Ltd.	UX60SC-MB-5ST(80)
4	PAD1, PAD2, PAD3, PAD4	Mech. HW Rubber Pad, Cylindrical, D7.9, H5.3, Black	3M	SJ61A11
2	Q1, Q2	MCHP Analog PWM Controller, 1 MHz, MCP87050-U/MF, PDFN-8	Microchip Technology Inc.	<b>MCP87050T-U/MF</b>

**Note 1:** The components listed in this Bill of Materials are representative of the PCB assembly. The released BOM used in manufacturing uses all RoHS-compliant components.

# PAC1921

**TABLE B-1: BILL OF MATERIALS (BOM)<sup>(1)</sup> (CONTINUED)**

Qty	Reference	Description	Manufacturer	Part Number
1	R1	Res., TKF, 100R, 1%, 1/10W, SMD, 0603	ROHM Semiconductor	MCR03EZPFX1000
1	R12,	Res., TKF, 2k, 1%, 1/10W, SMD, 0603	Stackpole Electronics, Inc.	RMCF0603FT2K00
2	R2, R3	Res., TKF, 2R, 5%, 3/4W, SMD, 2010	Panasonic® - ECG	ERJ-12ZYJ2R0U
2	R20, R21	Res., TKF, 1k, 1%, 1/10W, SMD, 0603	Panasonic - ECG	ERJ-3EKF1001V
1	R25	Res., TKF, 2k, 1%, 1/10W, SMD, 0603	Stackpole Electronics, Inc.	RMCF0603FT2K00
1	R27	Res., TKF, 1M, 1%, 1/10W, SMD, 0603	Panasonic - ECG	ERJ-3EKF1004V
4	R4, R5, R37, R38	Res., TKF, 120R, 1%, 1/10W, SMD, 0603	Panasonic - ECG	ERJ-3EKF1200V
2	R40, R49	Res., TKF, 15.4k, 1%, 1/10W, SMD, 0603	Panasonic - ECG	ERJ-3EKF1542V
2	R43, R46	Res., TKF, 3.32k, 1%, 1/10W, SMD, 0603	ROHM	MCR03EZPFX3321
2	R43, R46	Res., TKF, 7.5k, 1%, 1/10W, SMD, 0603	Panasonic - ECG	ERJ-3EKF7501V
1	R51	Res., TKF, 12.1k, 1%, 1/10W, SMD, 0603	Panasonic - ECG	ERJ-3EKF1212V
12	R6, R7, R8, R9, R10, R11, R18, R19, R26, R41, R48, R50	Res., TKF, 12.1k, 1%, 1/10W, SMD, 0603	Panasonic - ECG	ERJ-3EKF1212V
2	R70, R72	Res., TKF, 20R, 1%, 1/10W, SMD, 0603	Panasonic - ECG	ERJ-3EKF20R0V
2	R73, R74	Res., Trimmer Cermet, 10k, 10%, 500 mW, TH, 3386F	Bourns®, Inc.	3386F-1-103TLF
1	RS1	Res., Shunt, 0.005R, 1%, 2W, 1%, 2412	Ohmite® Manufacturing	LVK25R005FER
1	TP1	Conn. TP Loop, Orange, TH	Keystone Electronics Corp.	5013
2	TP2, TP7	Conn. TP Loop, Yellow, TH	Keystone Electronics Corp.	5014
2	TP3, TP4	Conn. TP Loop, White, TH	Keystone Electronics Corp.	5012
1	TP5	Conn. TP Loop, Red, TH	Keystone Electronics Corp.	5010
1	TP6	Conn. TP Loop, Black, TH	Keystone Electronics Corp.	5011
1	U1	MCHP Analog Current Sense Monitor, PAC1921-1-AIA-TR, DFN-10	Microchip Technology Inc.	<b>PAC1921-1-AIA-TR</b>
1	U2	MCHP Interface USB I <sup>2</sup> C™ UART, MCP2221-I/ST, TSSOP-14	Microchip Technology Inc.	<b>MCP2221-I/ST</b>
1	U3	MCHP Analog LDO, 3.3V, MCP1825ST-3302E/DB, SOT-223-3	Microchip Technology Inc.	<b>MCP1825S-3302E/DB</b>
1	U4	MCHP Analog Op Amp, 4-Ch, 1 MHz, MCP6004-I/SL, SOIC-14	Microchip Technology Inc.	<b>MCP6004-I/SL</b>

**Note 1:** The components listed in this Bill of Materials are representative of the PCB assembly. The released BOM used in manufacturing uses all RoHS-compliant components.

**NOTES:**



# MICROCHIP

## Worldwide Sales and Service

### AMERICAS

**Corporate Office**  
2355 West Chandler Blvd.  
Chandler, AZ 85224-6199  
Tel: 480-792-7200  
Fax: 480-792-7277  
Technical Support:  
<http://www.microchip.com/support>  
Web Address:  
[www.microchip.com](http://www.microchip.com)

**Atlanta**  
Duluth, GA  
Tel: 678-957-9614  
Fax: 678-957-1455

**Austin, TX**  
Tel: 512-257-3370

**Boston**  
Westborough, MA  
Tel: 774-760-0087  
Fax: 774-760-0088

**Chicago**  
Itasca, IL  
Tel: 630-285-0071  
Fax: 630-285-0075

**Cleveland**  
Independence, OH  
Tel: 216-447-0464  
Fax: 216-447-0643

**Dallas**  
Addison, TX  
Tel: 972-818-7423  
Fax: 972-818-2924

**Detroit**  
Novi, MI  
Tel: 248-848-4000

**Houston, TX**  
Tel: 281-894-5983

**Indianapolis**  
Noblesville, IN  
Tel: 317-773-8323  
Fax: 317-773-5453

**Los Angeles**  
Mission Viejo, CA  
Tel: 949-462-9523  
Fax: 949-462-9608

**New York, NY**  
Tel: 631-435-6000

**San Jose, CA**  
Tel: 408-735-9110

**Canada - Toronto**  
Tel: 905-673-0699  
Fax: 905-673-6509

### ASIA/PACIFIC

**Asia Pacific Office**  
Suites 3707-14, 37th Floor  
Tower 6, The Gateway  
Harbour City, Kowloon  
Hong Kong  
Tel: 852-2943-5100  
Fax: 852-2401-3431

**Australia - Sydney**  
Tel: 61-2-9868-6733  
Fax: 61-2-9868-6755

**China - Beijing**  
Tel: 86-10-8569-7000  
Fax: 86-10-8528-2104

**China - Chengdu**  
Tel: 86-28-8665-5511  
Fax: 86-28-8665-7889

**China - Chongqing**  
Tel: 86-23-8980-9588  
Fax: 86-23-8980-9500

**China - Dongguan**  
Tel: 86-769-8702-9880

**China - Hangzhou**  
Tel: 86-571-8792-8115  
Fax: 86-571-8792-8116

**China - Hong Kong SAR**  
Tel: 852-2943-5100  
Fax: 852-2401-3431

**China - Nanjing**  
Tel: 86-25-8473-2460  
Fax: 86-25-8473-2470

**China - Qingdao**  
Tel: 86-532-8502-7355  
Fax: 86-532-8502-7205

**China - Shanghai**  
Tel: 86-21-5407-5533  
Fax: 86-21-5407-5066

**China - Shenyang**  
Tel: 86-24-2334-2829  
Fax: 86-24-2334-2393

**China - Shenzhen**  
Tel: 86-755-8864-2200  
Fax: 86-755-8203-1760

**China - Wuhan**  
Tel: 86-27-5980-5300  
Fax: 86-27-5980-5118

**China - Xian**  
Tel: 86-29-8833-7252  
Fax: 86-29-8833-7256

### ASIA/PACIFIC

**China - Xiamen**  
Tel: 86-592-2388138  
Fax: 86-592-2388130

**China - Zhuhai**  
Tel: 86-756-3210040  
Fax: 86-756-3210049

**India - Bangalore**  
Tel: 91-80-3090-4444  
Fax: 91-80-3090-4123

**India - New Delhi**  
Tel: 91-11-4160-8631  
Fax: 91-11-4160-8632

**India - Pune**  
Tel: 91-20-3019-1500

**Japan - Osaka**  
Tel: 81-6-6152-7160  
Fax: 81-6-6152-9310

**Japan - Tokyo**  
Tel: 81-3-6880-3770  
Fax: 81-3-6880-3771

**Korea - Daegu**  
Tel: 82-53-744-4301  
Fax: 82-53-744-4302

**Korea - Seoul**  
Tel: 82-2-554-7200  
Fax: 82-2-558-5932 or  
82-2-558-5934

**Malaysia - Kuala Lumpur**  
Tel: 60-3-6201-9857  
Fax: 60-3-6201-9859

**Malaysia - Penang**  
Tel: 60-4-227-8870  
Fax: 60-4-227-4068

**Philippines - Manila**  
Tel: 63-2-634-9065  
Fax: 63-2-634-9069

**Singapore**  
Tel: 65-6334-8870  
Fax: 65-6334-8850

**Taiwan - Hsin Chu**  
Tel: 886-3-5778-366  
Fax: 886-3-5770-955

**Taiwan - Kaohsiung**  
Tel: 886-7-213-7828

**Taiwan - Taipei**  
Tel: 886-2-2508-8600  
Fax: 886-2-2508-0102

**Thailand - Bangkok**  
Tel: 66-2-694-1351  
Fax: 66-2-694-1350

### EUROPE

**Austria - Wels**  
Tel: 43-7242-2244-39  
Fax: 43-7242-2244-393

**Denmark - Copenhagen**  
Tel: 45-4450-2828  
Fax: 45-4485-2829

**France - Paris**  
Tel: 33-1-69-53-63-20  
Fax: 33-1-69-30-90-79

**Germany - Dusseldorf**  
Tel: 49-2129-3766400

**Germany - Munich**  
Tel: 49-89-627-144-0  
Fax: 49-89-627-144-44

**Germany - Pforzheim**  
Tel: 49-7231-424750

**Italy - Milan**  
Tel: 39-0331-742611  
Fax: 39-0331-466781

**Italy - Venice**  
Tel: 39-049-7625286

**Netherlands - Drunen**  
Tel: 31-416-690399  
Fax: 31-416-690340

**Poland - Warsaw**  
Tel: 48-22-3325737

**Spain - Madrid**  
Tel: 34-91-708-08-90  
Fax: 34-91-708-08-91

**Sweden - Stockholm**  
Tel: 46-8-5090-4654

**UK - Wokingham**  
Tel: 44-118-921-5800  
Fax: 44-118-921-5820

01/27/15