

### Data Sheet



#### Description

The HDSP-H8x1/H8x3 is a 0.8 inch high, single-digit display series. These halogenated devices utilize AlInGaP red, orange, green and deep red chips. This device is halogenated.

All devices are categorized for luminous intensity. The orange and green devices are categorized for color. Use of similar device categories yields a uniform display.

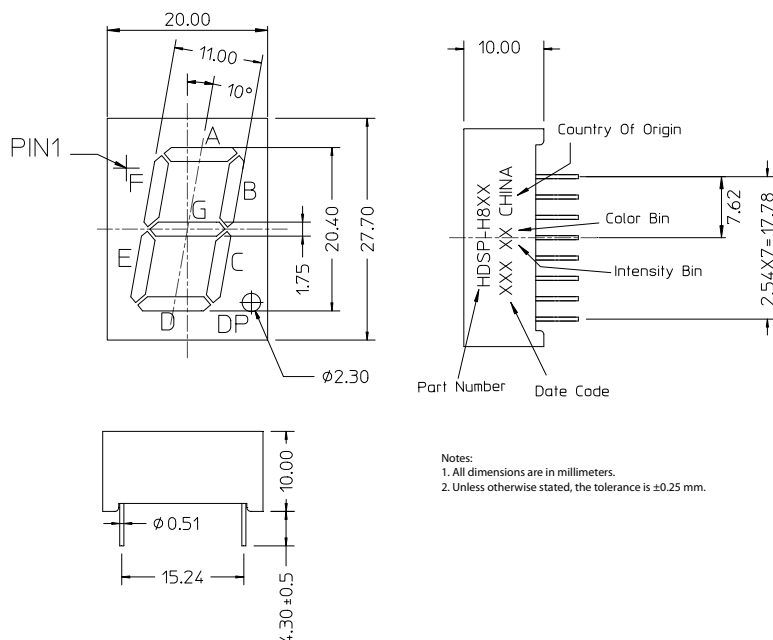
#### Features

- High reliability
- Excellent characters appearance
- Available in CA and CC
- RoHS Compliant
- Gray top surface with white diffused segments.

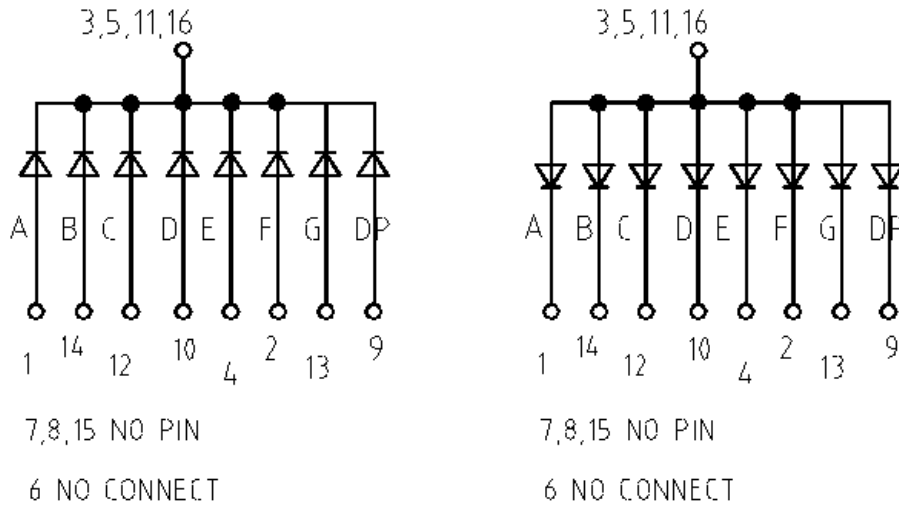
**Table 1 Ordering Information**

Red	Green	Orange	Deep Red	Description
HDSP-H8E1	HDSP-H8G1	HDSP-H8L1	HDSP-H8A1	Common Anode, Right Hand Decimal
HDSP-H8E3	HDSP-H8G3	HDSP-H8L3	HDSP-H8A3	Common Cathode, Right Hand Decimal

**Figure 1 Package Dimension**



**Figure 2 Circuit Diagram**



**Table 2 Absolute Maximum Ratings at  $T_A = 25^\circ\text{C}$**

Parameter	Symbol	Red/Orange/Green/Deep Red	Units
Power Dissipation per segment or Dot Point (DP)	$P_D$	52	mW
Continuous Forward Current per segment	$I_F$	20	mA
Peak Forward Current per segment (1/10 Duty Cycle, 0.1m sec pulse width)		100	mA
Derating Linearly from $25^\circ\text{C}$ per segment		0.21	mA/ $^\circ\text{C}$
Reverse Voltage per segment or DP	$V_R$	Not designed for reverse biasing	
Operating Temperature	$T_O$	-40 to 85	$^\circ\text{C}$
Storage Temperature	$T_S$	-40 to 85	$^\circ\text{C}$
Wave solder Condition 1.6mm below body		260 $^\circ\text{C}$ peak for 3 secs max	

**Table 3 Red Electrical/Optical Characteristics at  $T_A = 25^\circ\text{C}$**

Parameter	Symbol	Min	Typ	Max	Units	Test Conditions
Average Luminous Intensity (Digit Average)	$I_v$	—	30	—	mcd	$I_F = 10\text{ mA}$
Peak Wavelength	$\lambda_p$	—	634	—	nm	$I_F = 20\text{ mA}$
Dominant Wavelength	$\lambda_d$	—	625	—	nm	$I_F = 20\text{ mA}$
Forward Voltage per segment / DP	$V_F$	—	2.0	2.6	V	$I_F = 20\text{ mA}$
Reverse Current per segment / DP <sup>a</sup>	$I_R$	—	—	100	$\mu\text{A}$	$V_R = 5\text{ V}$
Luminous Intensity Matching Ratio (Segment to Segment)	$I_{v-M}$	—	2:1	—	—	$I_F = 10\text{ mA}$

a. Indicates production go-no-go test only. Long term reverse biasing is not recommended.

**Table 4 Green Electrical/Optical Characteristics at  $T_A = 25^\circ\text{C}$**

Parameter	Symbol	Min	Typ	Max	Units	Test Conditions
Average Luminous Intensity (Digit Average)	$I_V$	—	12	—	mcd	$I_F = 10\text{ mA}$
Peak Wavelength	$\lambda_p$	—	570	—	nm	$I_F = 20\text{ mA}$
Dominant Wavelength	$\lambda_d$	—	571	—	nm	$I_F = 20\text{ mA}$
Forward Voltage per segment / DP	$V_F$	—	2.0	2.6	V	$I_F = 20\text{ mA}$
Reverse Current per segment / DP <sup>a</sup>	$I_R$	—	—	100	$\mu\text{A}$	$V_R = 5\text{ V}$
Luminous Intensity Matching Ratio (Segment to Segment)	$I_{V-M}$	—	2:1	—	—	$I_F = 10\text{ mA}$

a. Indicates production go-no-go test only. Long term reverse biasing is not recommended.

**Table 5 Orange Electrical/Optical Characteristics at  $T_A = 25^\circ\text{C}$**

Parameter	Symbol	Min	Typ	Max	Units	Test Conditions
Average Luminous Intensity (Digit Average)	$I_V$	—	35	—	mcd	$I_F = 10\text{ mA}$
Peak Wavelength	$\lambda_p$	—	610	—	nm	$I_F = 20\text{ mA}$
Dominant Wavelength	$\lambda_d$	—	605	—	nm	$I_F = 20\text{ mA}$
Forward Voltage per segment / DP	$V_F$	—	2.0	2.6	V	$I_F = 20\text{ mA}$
Reverse Current per segment / DP <sup>a</sup>	$I_R$	—	—	100	$\mu\text{A}$	$V_R = 5\text{ V}$
Luminous Intensity Matching Ratio (Segment to Segment)	$I_{V-M}$	—	2:1	—	—	$I_F = 10\text{ mA}$

a. Indicates production go-no-go test only. Long term reverse biasing is not recommended.

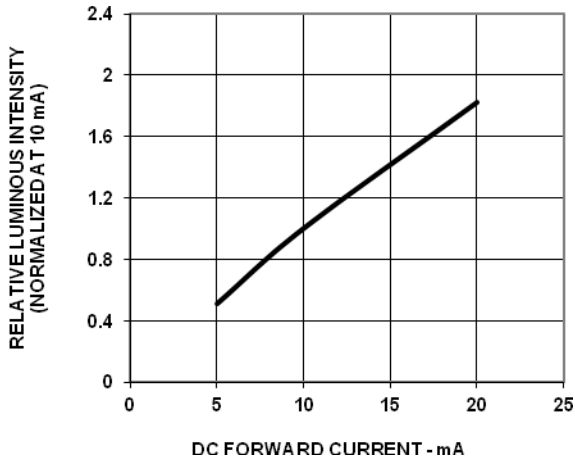
**Table 6 Deep Red Electrical/Optical Characteristics at  $T_A = 25^\circ\text{C}$**

Parameter	Symbol	Min	Typ	Max	Units	Test Conditions
Average Luminous Intensity (Digit Average)	$I_V$	—	29	—	mcd	$I_F = 10\text{ mA}$
Peak Wavelength	$\lambda_p$	—	644	—	nm	$I_F = 20\text{ mA}$
Dominant Wavelength	$\lambda_d$	—	635	—	nm	$I_F = 20\text{ mA}$
Forward Voltage per segment / DP	$V_F$	—	2.0	2.6	V	$I_F = 20\text{ mA}$
Reverse Current per segment / DP <sup>a</sup>	$I_R$	—	—	100	$\mu\text{A}$	5 V
Luminous Intensity Matching Ratio (Segment to Segment)	$I_{V-M}$	—	2:1	—	—	$I_F = 10\text{ mA}$

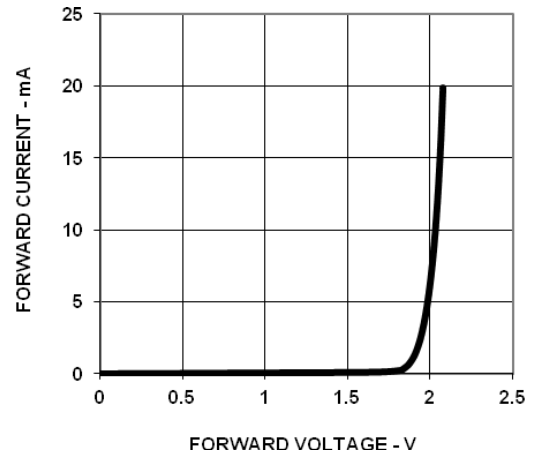
a. Indicates production go-no-go test only. Long term reverse biasing is not recommended.

# Red

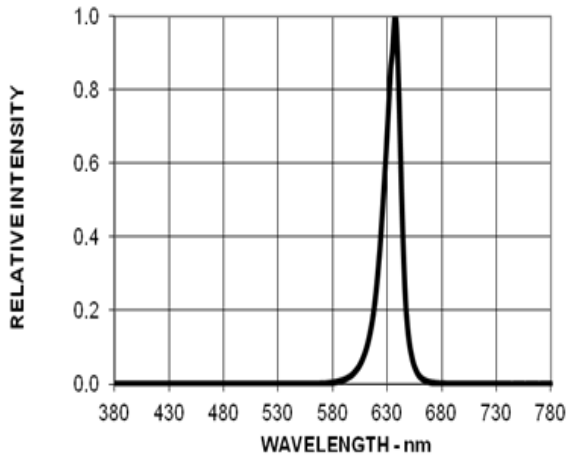
**Figure 3** Relative Luminous Intensity Vs Forward Current



**Figure 4** Forward Voltage Vs Current

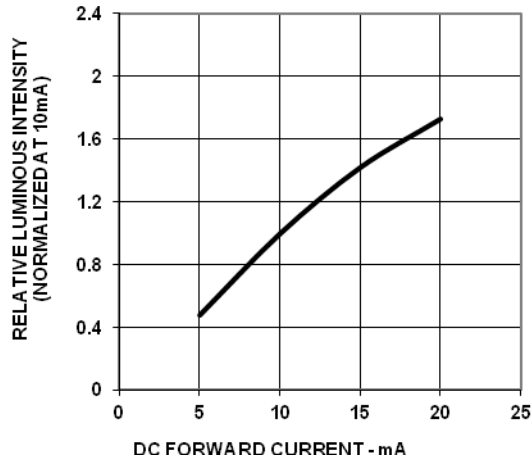


**Figure 5** Relative Luminous Intensity Vs Wavelength

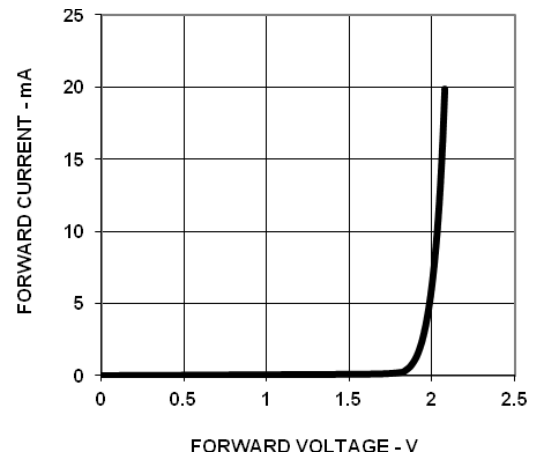


## Green

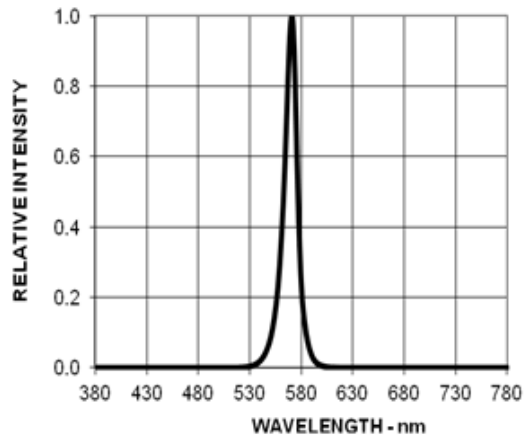
**Figure 6** Relative Luminous Intensity Vs Forward Current



**Figure 7** Forward Voltage Vs Current

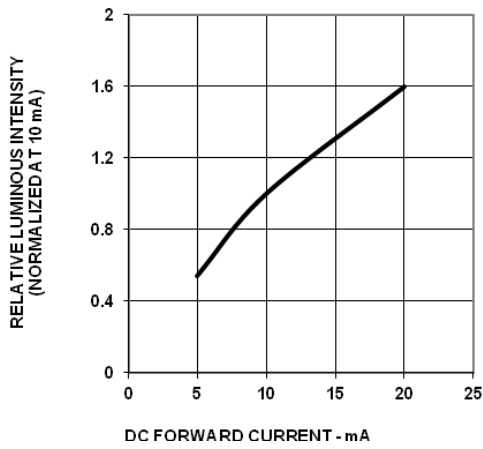


**Figure 8** Relative Luminous Intensity Vs Wavelength

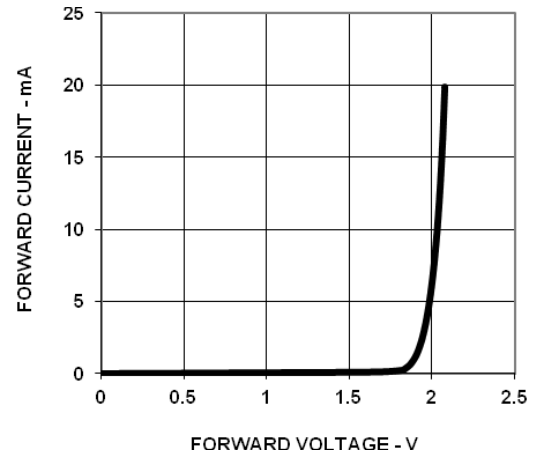


# Orange

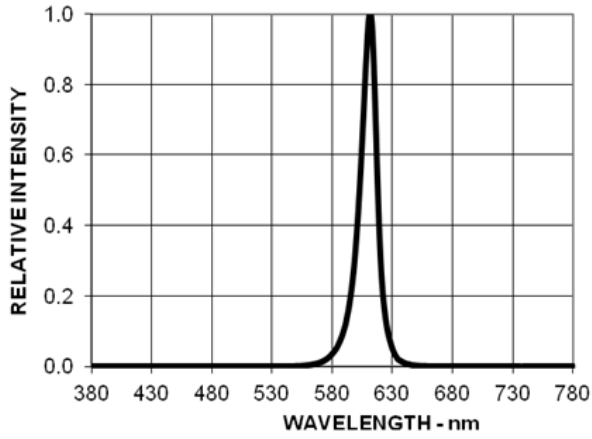
**Figure 9** Relative Luminous Intensity Vs Forward Current



**Figure 10** Forward Voltage Vs Current

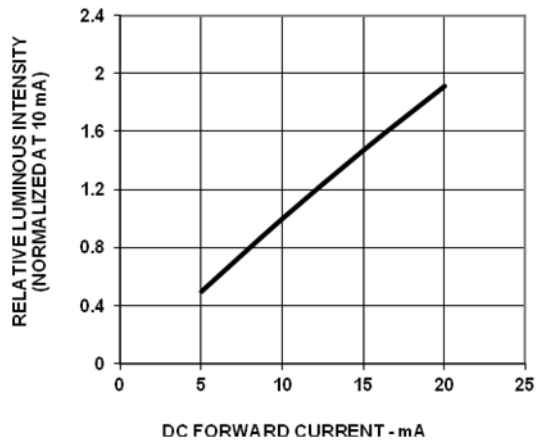


**Figure 11** Relative Luminous Intensity Vs Wavelength

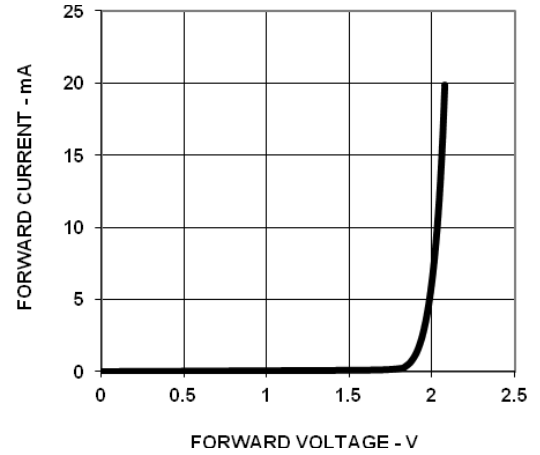


## Deep Red

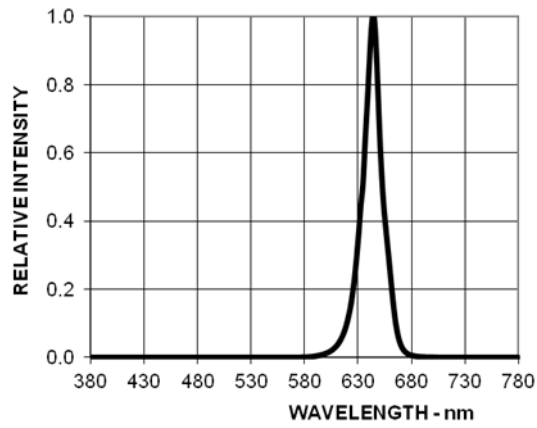
**Figure 12** Relative Luminous Intensity Vs Forward Current



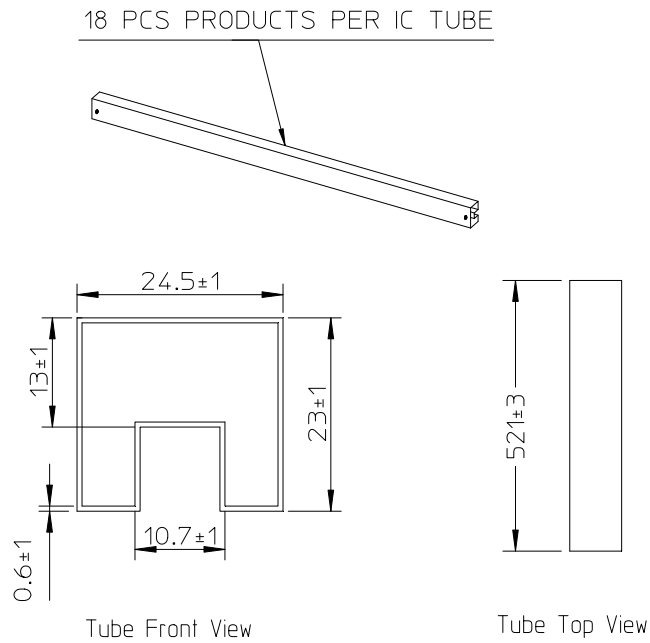
**Figure 13** Forward Voltage Vs Current



**Figure 14** Relative Luminous Intensity Vs Wavelength



## Packing Tube Specifications



## Reference

For further information on soldering LEDs, please refer to Avago Technologies Application Note 1027.

---

For product information and a complete list of distributors, please go to our web site:

[www.avagotech.com](http://www.avagotech.com)

Avago Technologies and the A logo are trademarks of Avago Technologies in the United States and other countries. All other brand and product names may be trademarks of their respective companies.

Data subject to change. Copyright © 2015 Avago Technologies. All Rights Reserved.

pub-005313 – December 16, 2015

**AVAGO**  
TECHNOLOGIES