



Product Description

The SBW-5089(Z) is a high performance InGaP/GaAs HBT MMIC Amplifier. A Darlington circuit fabricated with InGaP process technology provides broadband RF performance up to 8GHz and excellent thermal performance. The heterojunction increases breakdown voltage and minimizes leakage current between junctions. Cancellation of emitter junction non-linearities results in high suppression of intermodulation products. Operation requires only a single positive voltage supply, 2 DC-blocking capacitors, a bias resistor and an RF choke.

Features

- Available in RoHS Compliant and Pb-Free (Z Part Number)
- 50Ω Cascadable Gain Block
- Wideband Flat Gain to 3GHz: +/-1.4 dB
- $P_{1dB} = 13.4$ at 6GHz
- Input / Output VSWR < 2:3 to 8GHz
- Patented Thermal Design
- Single Voltage Supply Operation

Applications

- Wideband Instrumentation
- Fiber Optic Driver
- OC-48
- Basestation
- SAT COM

Gain Return Loss versus Frequency, $I_D = 80$ mA (Typ), Tuned Application Circuit

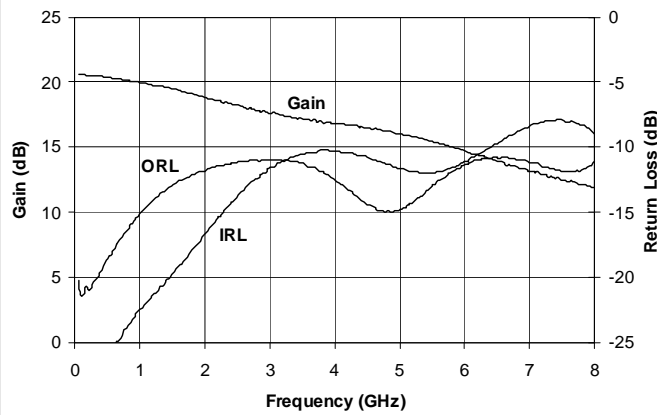

Optimum Technology Matching® Applied

- GaAs HBT
- GaAs MESFET
- InGaP HBT
- SiGe BiCMOS
- Si BiCMOS
- SiGe HBT
- GaAs pHEMT
- Si CMOS
- Si BJT
- GaN HEMT
- InP HBT
- RF MEMS
- LDMOS

Parameter	Specification			Unit	Condition
	Min.	Typ.	Max.		
Small Signal Gain, PC board and connector losses de-embedded	19.3	20.3	21.3	dB	850MHz
	16.7	17.5	19.0	dB	3000MHz
		17.2		dB	4200MHz
	14.2	15.0	16.5	dB	6000MHz
Output Power at 1dB Compression		20.1		dBm	850MHz
	18.4	19.4		dBm	1950MHz
Output Third Order Intercept Point		35.5		dBm	850MHz
	32.0	34.0		dBm	1950MHz
Output Power		13.0		dBm	1950MHz, -45dBc ACP IS-95 9 Forward Channels (P_{OUT})
Determined by Return Loss		6000		MHz	>10dB
Noise Figure		3.9	4.4	dB	1950MHz
Worst case Input Return Loss	7.0	10.0		dB	DCto6000MHz
Worst case Output Return Loss	8.0	10.0		dB	DCto6000MHz
Device Operating Voltage	4.5	4.9	5.3	V	
Device Operating Current	72.0	80.0	88.0	mA	
Thermal Resistance		70		°C/W	junction to backside

Test Conditions: $V_S = 8$ V $I_D = 80$ mA Typ. OIP_3 Tone Spacing = 1MHz $T_L = 25$ °C
 Bias Resistance = 39Ω P_{OUT} per tone = 0dBm $Z_S = Z_L = 50$ Ω

Absolute Maximum Ratings

Parameter	Rating	Unit
Max Device Current (I_D)	130	mA
Max Device Voltage (V_D)	6	V
Max RF Input Power	17	dBm
Max Dissipated Power	0.65	W
Max Junction Temperature (T_J)	150	°C
Operating Temperature Range (T_L)	-40 to +85	°C
Max Storage Temperature	150	°C
ESD Rating - Human Body Model	1C	Class
Moisture Sensitivity Level	MSL 2	



Caution! ESD sensitive device.

Exceeding any one or a combination of the Absolute Maximum Rating conditions may cause permanent damage to the device. Extended application of Absolute Maximum Rating conditions to the device may reduce device reliability. Specified typical performance or functional operation of the device under Absolute Maximum Rating conditions is not implied.

RoHS status based on EU Directive 2002/95/EC (at time of this document revision).

The information in this publication is believed to be accurate and reliable. However, no responsibility is assumed by RF Micro Devices, Inc. ("RFMD") for its use, nor for any infringement of patents, or other rights of third parties, resulting from its use. No license is granted by implication or otherwise under any patent or patent rights of RFMD. RFMD reserves the right to change component circuitry, recommended application circuitry and specifications at any time without prior notice.

Typical Performance at Key Operating Frequencies

Parameter	Units	500MHz	850MHz	1950MHz	2400MHz	3500MHz	5800MHz
Small Signal Gain	dB	20.5	20.3	19.1	18.7	17.3	15.1
Output Third Order Intercept Point	dBm	36.5	35.5	34.0	33.0	30.5	25.5
Output Power at 1dB Compression	dBm	20.2	20.1	19.4	19.4	17.5	13.4
Input Return Loss	dB	26	26	19	15	12	12.5
Output Return Loss	dB	19	17.5	12	11	10.5	10.9
Reverse Isolation	dB	22	23	23	23	23	23
Noise Figure	dB	3.6	3.6	3.9	3.9	4.1	4.3

Test Conditions: $V_S = 8V$, $I_D = 80mA$ Typ, OIP_3 Tone Spacing = 1 MHz, P_{OUT} per tone = 0 dBm, $T_L = 25^\circ C$, Bias Resistance = 39Ω, $Z_S = Z_L = 50\Omega$.

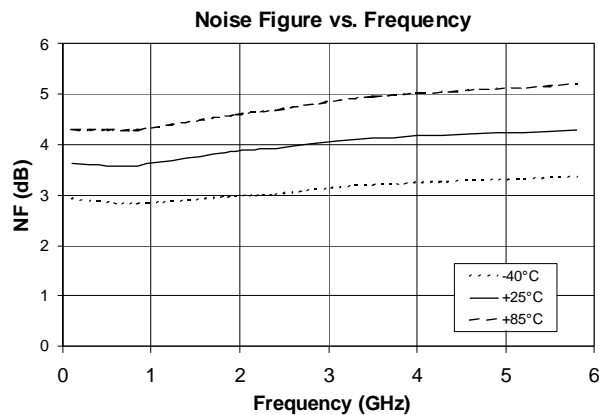
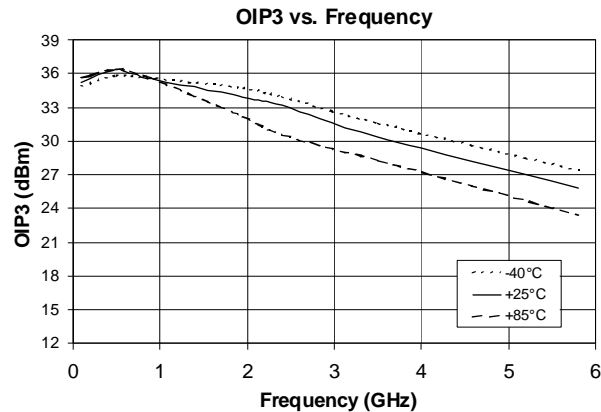
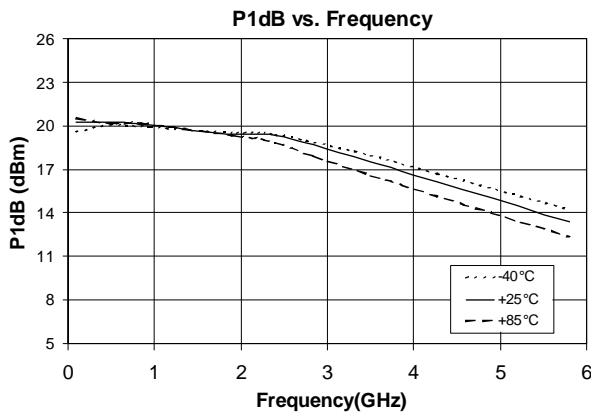

RF Performance With Basic Application Circuit (Bias: $I_D = 80\text{ mA Typ.}$)

S_{21} vs. Frequency

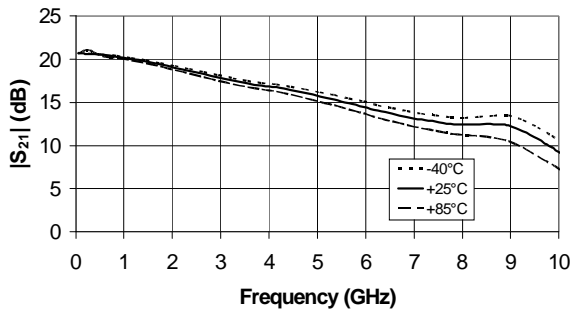

S_{11} vs. Frequency

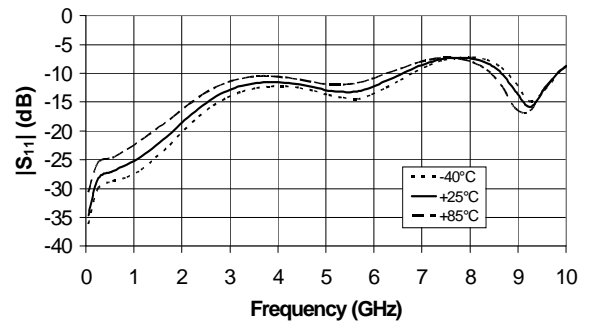

S_{12} vs. Frequency

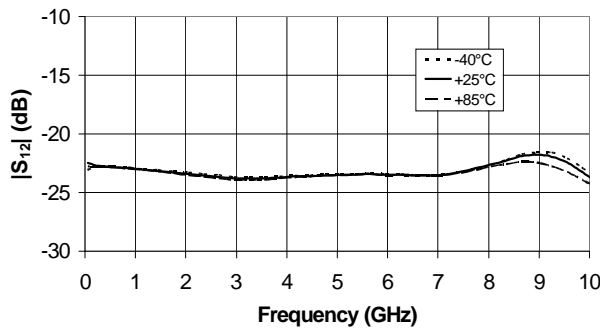

S_{22} vs. Frequency

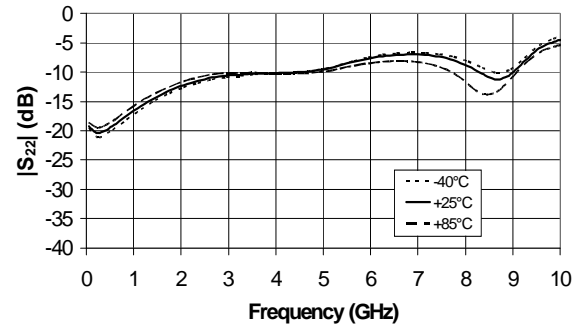

IS-95 @ 850MHz
Adj. Channel Pwr. vs. Channel output Pwr.

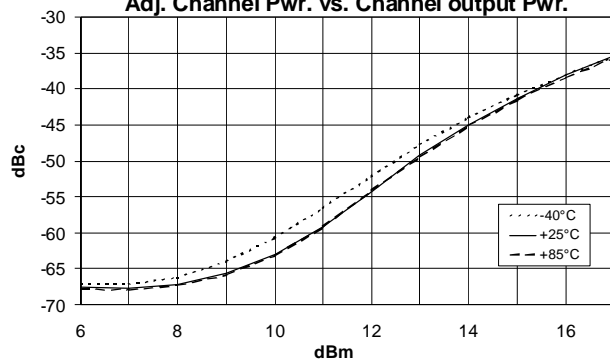

IS-95 @ 1950MHz
Adj. Channel Pwr. vs. Channel Output Power

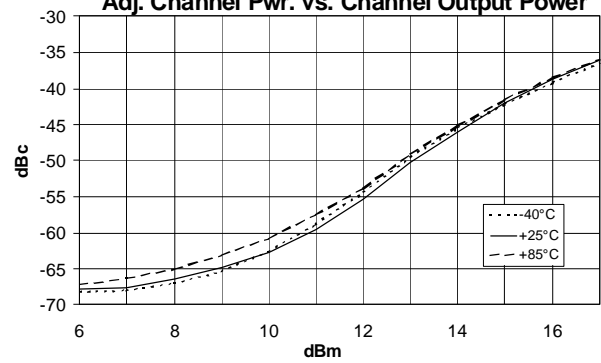

Note: Full S-Parameter data available at www.RFMD.com

SBW-5089(Z)



RFMD + TriQuint = Qorvo

Typical RF Performance With Tuned Application Circuit (Bias: $I_D=80\text{mA}$ Typ.)

S_{21} vs. Frequency

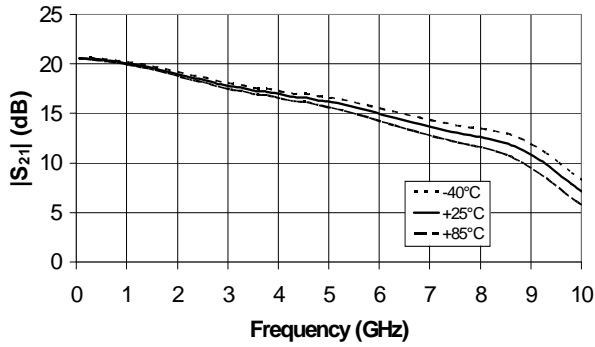

S_{11} vs. Frequency

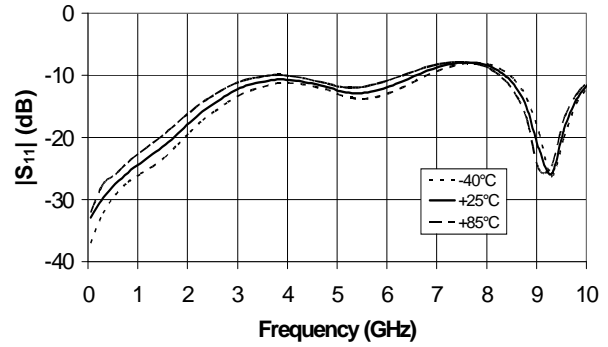

S_{12} vs. Frequency

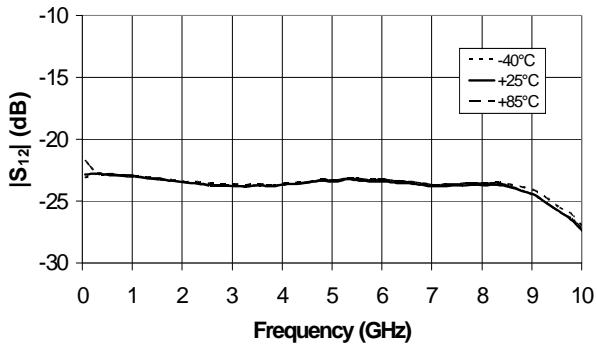

S_{22} vs. Frequency

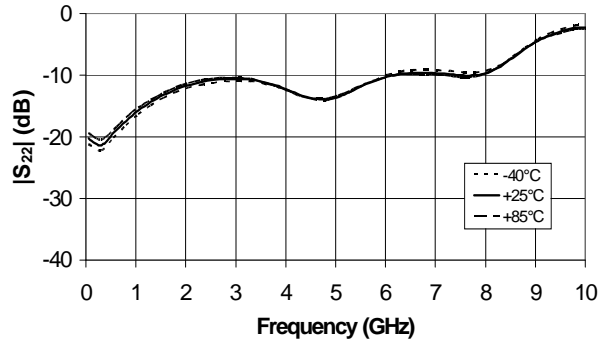

Application Circuit Schematic

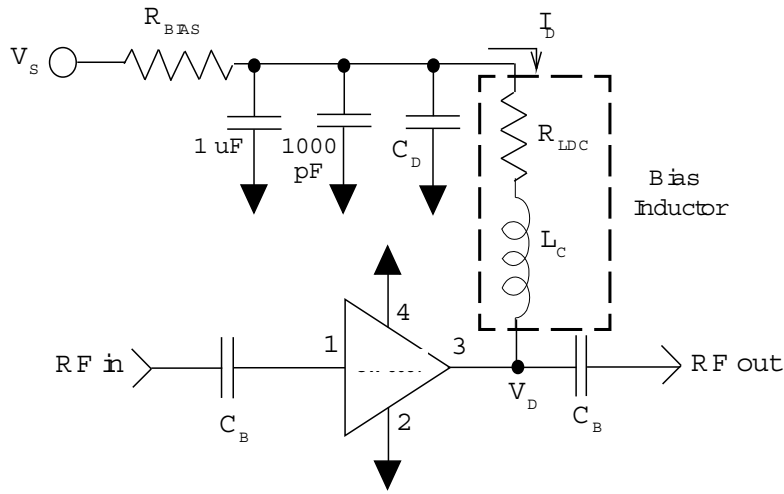

Application Circuit Layout

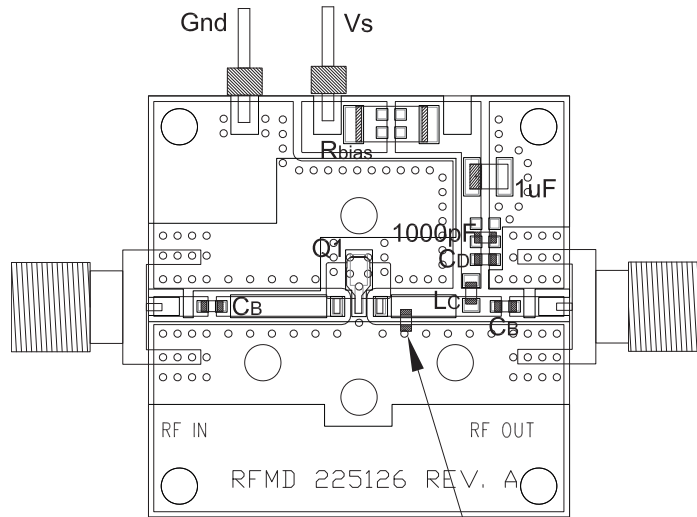

Optional 0.1pF cap placement for better 6GHz output return loss

Application Circuit Element Values

Reference Designator	100MHz	500MHz	850MHz	1950MHz	2400MHz	3500MHz
C _B	1000 pF	220 pF	100 pF	68 pF	56 pF	39 pF
C _D	100 pF	100 pF	68 pF	22 pF	22 pF	15 pF
L _C	470 nH	68 nH	33 nH	22 nH	18 nH	15 nH

Recommended Bias Resistance for I_D=80mA

Supply Voltage (V _S) (Volts)	<7	7	7.5	8	9	10	12
Bias Resistance* (Ω)	N/R	26	33	39	52	64	89

*Bias Resistance = $R_{BIAS} + R_{LDC} = (V_S - V_D) / I_D$

Select R_{BIAS} so that $R_{BIAS} + R_{LDC} \sim$ the recommended bias resistance. Use 1% or 5% tolerance resistors or parallel combinations to attain the recommended bias resistance $\pm 3\%$. R_{BIAS} provides current stability over temperature.

*N/R=Not recommended. Contact RFMD technical support for guidance when available supply voltage is <7V.

Pin	Function	Description
1	RF IN	RF input pin. This pin requires the use of an external DC-blocking capacitor chosen for the frequency of operation.
2, 4	GND	Connection to ground. Provide via holes as close to the device ground leads as possible to reduce ground inductance and achieve RF performance.
3	RF OUT/DC BIAS	RF output and bias pin. This pin requires the use of an external DC-blocking capacitor chosen for the frequency of operation.

Suggested Pad Layout

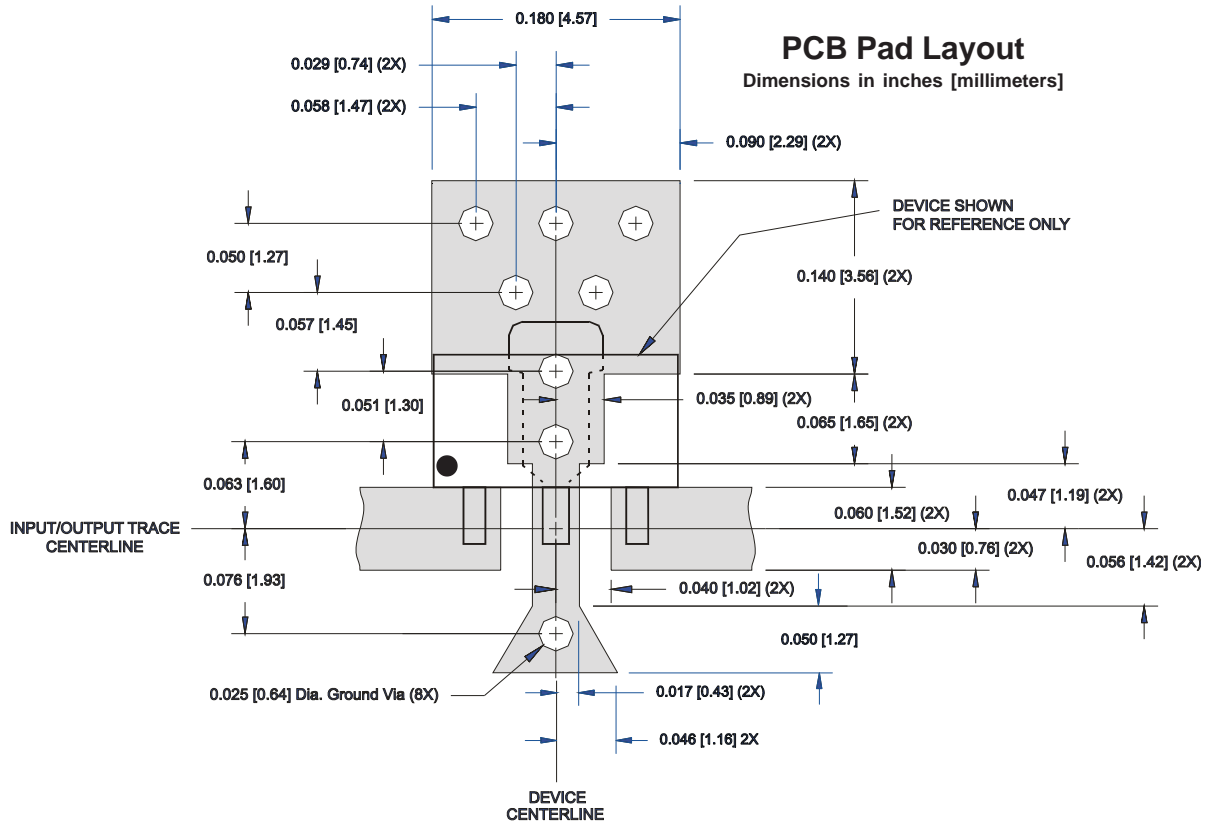

Notes:

1. Solder the copper pad on the backside of the device package to the ground plane.
2. Provide a large ground pad area under device pins 1, 2, 4, and 5 with many plated via holes as shown.
3. Dimensions given for 50Ω I/O lines are for 31mil thick Getek. Scale accordingly for different board thicknesses and dielectric contacts.
4. We recommend 1 or 2 ounce copper. Measurements for this data sheet were made on a 31mil thick Getek with 1 ounce copper on both sides.

Package Drawing

Dimensions in inches (millimeters)

Refer to drawing posted at www.rfmd.com for tolerances.

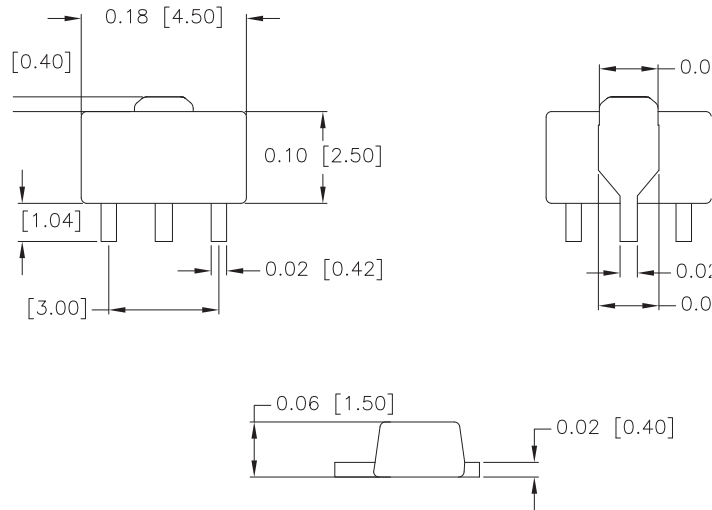

Part Identification Marking

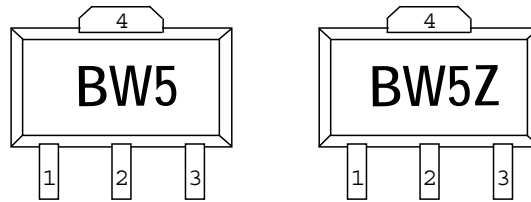

Alternate marking "SBW5089" or "SBW5089Z" on line one with Trace Code on line two.

Ordering Information

Part Number	Description	Reel Size	Devices/Reel
SBW-5089	Tin-Lead	7"	1000
SBW-5089Z	Lead Free, RoHS Compliant	7"	1000