

# RJ45 PoE 10/100 Base-TX Jack with Magnetic Module



16.26 x 13.84 x 21.59 mm

**RoHS**  
Compliant

**ARJP11A**

## FEATURES:

- PoE
- Available with or without LED
- Suitable CAT 5 & 6 cable and UTP
- Comply IEEE 802.3ab
- LAN Magnetic with RJ45
- Suitable for RoHS compliant reflow

## APPLICATIONS:

- 10/100 base-TX LAN
- NIC, LoM and PC

## STANDARD SPECIFICATIONS at 25°C

**Operating temperature range: 0°C to +70°C    Storage temperature range: -40°C to +85°C**

Part Number	Turns Ratio $\pm 3\%$		EMI Fingers	LEDs L/R	Insertion Loss (dB max) 0.3- 100 MHz	Return Loss (dB MIN @100Ω)			
	TX	RX				0.5- 30 MHz	40 MHz	50 MHz	60 - 80 MHz
ARJP11A-MASA-B-A-EMU2	1CT:1CT	1CT:1CT	YES	Y/G	-1.1	-18	-15.5	-13.6	-12
ARJP11A-MASA-B-A-FMU2	1CT:1CT	1CT:1CT	YES	Y/G	-1.1	-18	-15.5	-13.6	-12
ARJP11A-MBSB-A-B-EMU2	1CT:1CT	1CT:1CT	YES	G/Y	-1.1	-18	-15.5	-13.6	-12
ARJP11A-MBSB-A-B-FMU2	1CT:1CT	1CT:1CT	YES	G/Y	-1.1	-18	-15.5	-13.6	-12

Part Number	Crosstalk (dB TYP)	Common Mode Rejection (dB TYP)			Hipot (Vrms min)
	0.3 - 100 MHz	0.3 - 30 MHz	30 - 60 MHz	60 - 100 MHz	
ARJP11A-MASA-B-A-EMU2	-38	-50	-40	-30	1500
ARJP11A-MASA-B-A-FMU2	-38	-50	-40	-30	1500
ARJP11A-MBSB-A-B-EMU2	-38	-50	-40	-30	1500
ARJP11A-MBSB-A-B-FMU2	-38	-50	-40	-30	1500

Contact Abracon for more custom configurations. See options to build a custom configuration.

## OPTIONS AND PART IDENTIFICATION

ARJP11A -   -  -  -

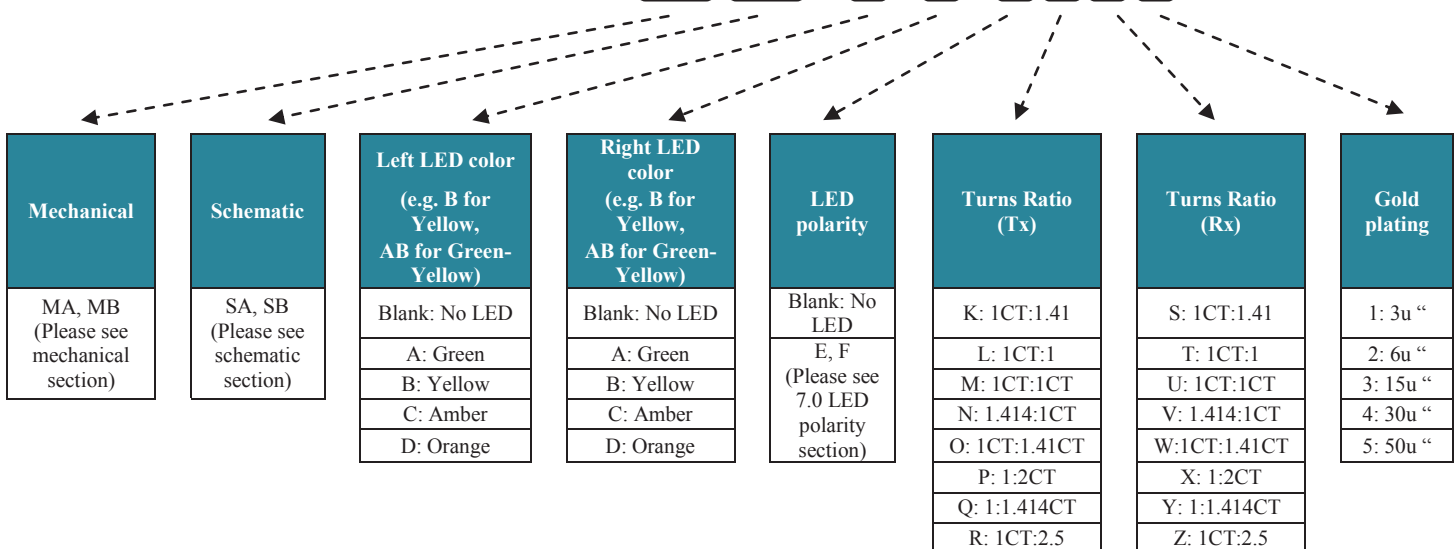

# RJ45 PoE 10/100 Base-TX Jack with Magnetic Module

ARJP11A

RoHS  
Compliant



16.26 x 13.84 x 21.59 mm

## MECHANICAL DIMENSIONS

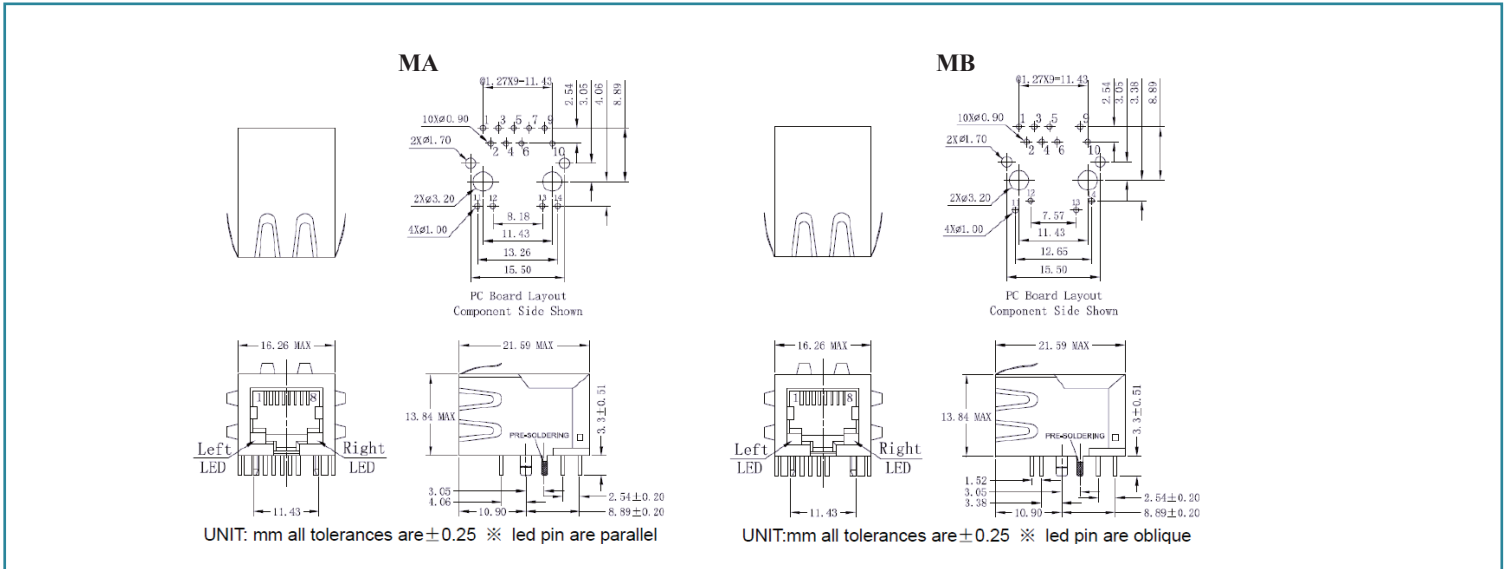

## SCHEMATICS

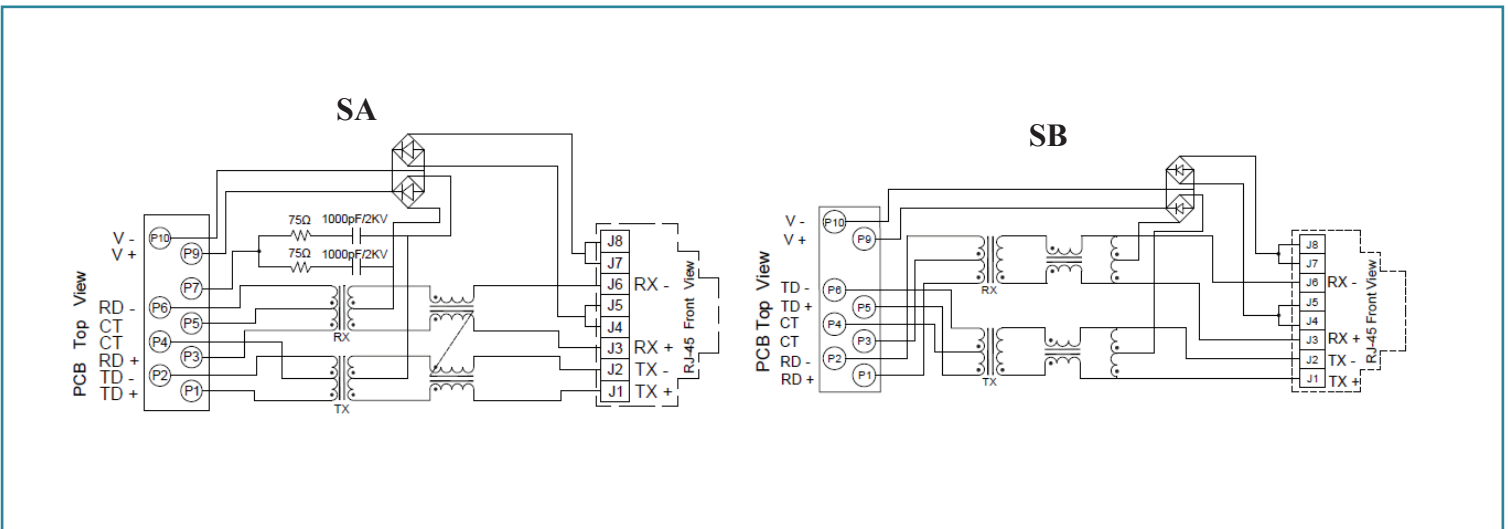

## LED POLARITY

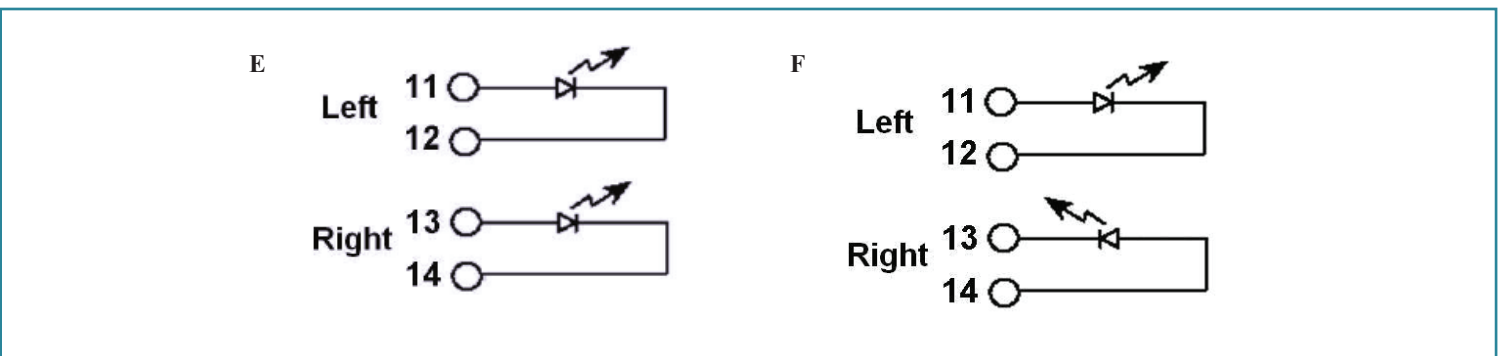

# RJ45 PoE 10/100 Base-TX Jack with Magnetic Module

ARJP11A

RoHS  
Compliant



16.26 x 13.84 x 21.59 mm

PACKING: 60pcs/tray

Packaging material: PET

Outer carton unit : 1320 pcs/ 22 Trays/box

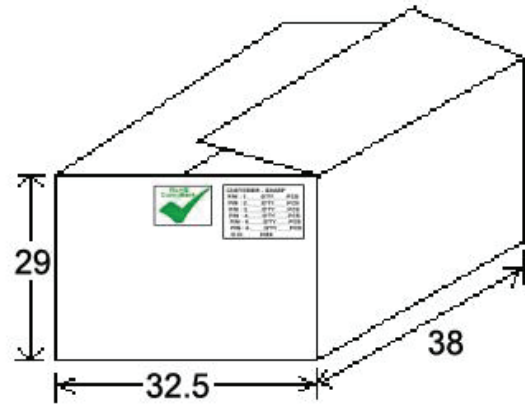
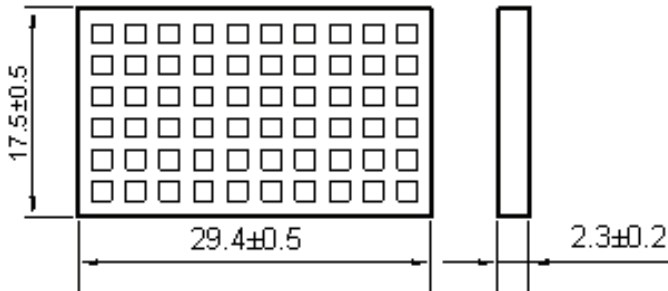

REFLOW PROFILE:

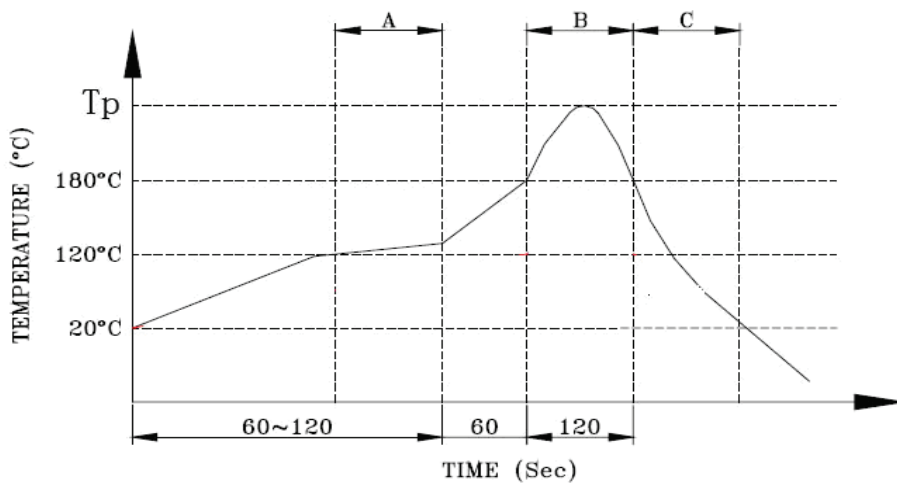

Peak temperature( $T_p$ ) :  $250 \pm 10^\circ\text{C}$   
Peak temperature( $T_p$ ) time : 5sec max

A. Preheating B. Soldering C. Gradual Cooling

**ATTENTION:** Abracon Corporation's products are COTS – Commercial-Off-The-Shelf products; suitable for Commercial, Industrial and, where designated, Automotive Applications. Abracon's products are not specifically designed for Military, Aviation, Aerospace, Life-dependant Medical applications or any application requiring high reliability where component failure could result in loss of life and/or property. For applications requiring high reliability and/or presenting an extreme operating environment, written consent and authorization from Abracon Corporation is required. Please contact Abracon Corporation for more information.

ABRACON IS  
ISO 9001:2008  
CERTIFIED



Visit [www.abracon.com](http://www.abracon.com) for Terms & Conditions of Sale  
30332 Esperanza, Rancho Santa Margarita, California 92688  
tel 949-546-8000 | fax 949-546-8001 | [www.abracon.com](http://www.abracon.com)

Revised: 05.13.16