

THIS DOCUMENT IS THE PROPERTY OF
KEYSTONE ELECTRONICS CORP. AND
SHALL NOT BE REPRODUCED, DISTRIBUTED
OR USED AS A BASIS FOR MANUFACTURE
WITHOUT PRIOR WRITTEN PERMISSION
FROM KEYSTONE ELECTRONICS CORP.

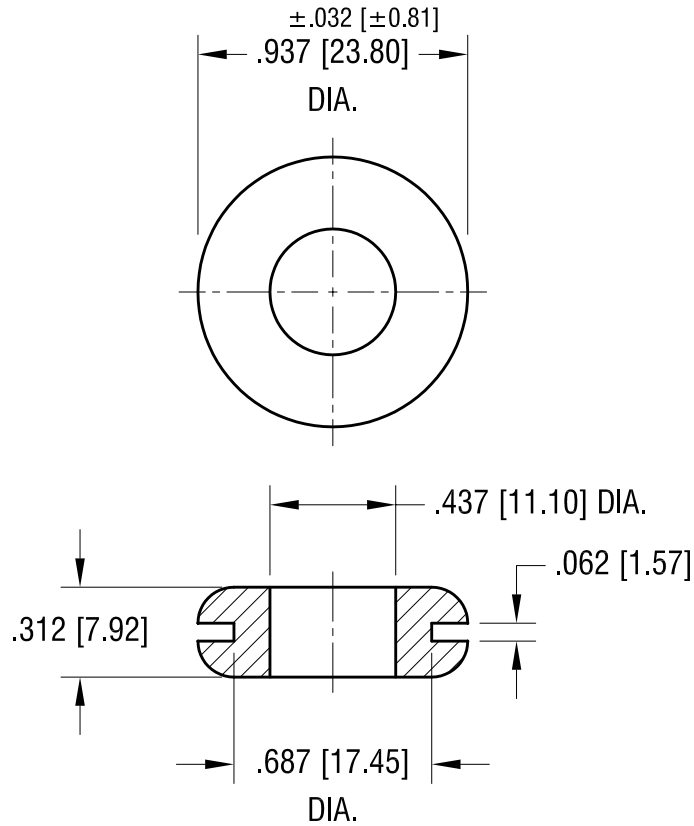

KEYSTONE ELECTRONICS CORP.

ASTORIA, N.Y. 11105-2017

PART NAME

RUBBER GROMMET

MATERIAL

BUNA N

FINISH

-

DRN BY

BOONE

DATE

9.16.96

APP'D

LN

SCALE

1.5X

1.02.08

CHANGE AS PER ECN 08-013

A

TOLERANCES

INCH [MM]

CODE

DWG NO.

DECIMAL $\pm .020$ [± 0.50]

C/M

ANGULAR $\pm 1^\circ$
UNLESS OTHERWISE SPECIFIED

746

DATE

DESCRIPTION

REV.