

# RF Power Field Effect Transistors

## N-Channel Enhancement-Mode Lateral MOSFETs

RF Power transistors designed for applications operating at frequencies between 1200 and 1400 MHz, 1% to 12% duty cycle. These devices are suitable for use in pulsed applications.

- Typical Pulsed Performance:  $V_{DD} = 50$  Volts,  $I_{DQ} = 150$  mA,  $P_{out} = 330$  Watts Peak (39.6 W Avg.),  $f = 1400$  MHz, Pulse Width = 300  $\mu$ sec, Duty Cycle = 12%  
Power Gain — 18 dB  
Drain Efficiency — 60.5%
- Capable of Handling 5:1 VSWR, @ 50 Vdc, 1400 MHz, 330 Watts Peak Power

### Features

- Characterized with Series Equivalent Large-Signal Impedance Parameters
- Internally Matched for Ease of Use
- Qualified Up to a Maximum of 50  $V_{DD}$  Operation
- Integrated ESD Protection
- Greater Negative Gate-Source Voltage Range for Improved Class C Operation
- RoHS Compliant
- In Tape and Reel. R3 Suffix = 250 Units per 56 mm, 13 inch Reel.

**MRF6V14300HR3**  
**MRF6V14300HSR3**

**1400 MHz, 330 W, 50 V**  
**PULSED**  
**LATERAL N-CHANNEL**  
**RF POWER MOSFETs**

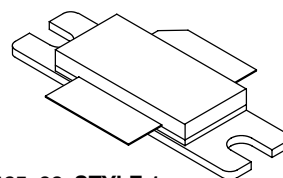

**CASE 465-06, STYLE 1**  
**NI-780**  
**MRF6V14300HR3**

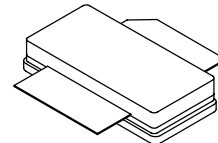

**CASE 465A-06, STYLE 1**  
**NI-780S**  
**MRF6V14300HSR3**

**Table 1. Maximum Ratings**

Rating	Symbol	Value	Unit
Drain-Source Voltage	$V_{DSS}$	-0.5, +100	Vdc
Gate-Source Voltage	$V_{GS}$	-6.0, +10	Vdc
Storage Temperature Range	$T_{stg}$	-65 to +150	$^{\circ}$ C
Case Operating Temperature	$T_C$	150	$^{\circ}$ C
Operating Junction Temperature (1,2)	$T_J$	225	$^{\circ}$ C

**Table 2. Thermal Characteristics**

Characteristic	Symbol	Value (2,3)	Unit
Thermal Resistance, Junction to Case Case Temperature 65 $^{\circ}$ C, 330 W Pulsed, 300 $\mu$ sec Pulse Width, 12% Duty Cycle	$Z_{\theta JC}$	0.13	$^{\circ}$ C/W

1. Continuous use at maximum temperature will affect MTTF.
2. MTTF calculator available at <http://www.freescale.com/rf>. Select Software & Tools/Development Tools/Calculators to access MTTF calculators by product.
3. Refer to AN1955, *Thermal Measurement Methodology of RF Power Amplifiers*. Go to <http://www.freescale.com/rf>. Select Documentation/Application Notes - AN1955.

**Table 3. ESD Protection Characteristics**

Test Methodology	Class
Human Body Model (per JESD22-A114)	1C (Minimum)
Machine Model (per EIA/JESD22-A115)	A (Minimum)
Charge Device Model (per JESD22-C101)	IV (Minimum)

**Table 4. Electrical Characteristics** ( $T_A = 25^\circ\text{C}$  unless otherwise noted)

Characteristic	Symbol	Min	Typ	Max	Unit
----------------	--------	-----	-----	-----	------

**Off Characteristics**

Gate-Source Leakage Current ( $V_{GS} = 5\text{ Vdc}$ , $V_{DS} = 0\text{ Vdc}$ )	$I_{GSS}$	—	—	10	$\mu\text{Adc}$
Drain-Source Breakdown Voltage ( $V_{GS} = 0\text{ Vdc}$ , $I_D = 100\text{ mA}$ )	$V_{(BR)DSS}$	100	—	—	Vdc
Zero Gate Voltage Drain Leakage Current ( $V_{DS} = 50\text{ Vdc}$ , $V_{GS} = 0\text{ Vdc}$ )	$I_{DSS}$	—	—	50	$\mu\text{Adc}$
Zero Gate Voltage Drain Leakage Current ( $V_{DS} = 90\text{ Vdc}$ , $V_{GS} = 0\text{ Vdc}$ )	$I_{DSS}$	—	—	2.5	mA

**On Characteristics**

Gate Threshold Voltage ( $V_{DS} = 10\text{ Vdc}$ , $I_D = 662\ \mu\text{Adc}$ )	$V_{GS(th)}$	0.9	1.6	2.4	Vdc
Gate Quiescent Voltage ( $V_{DD} = 50\text{ Vdc}$ , $I_D = 150\text{ mAdc}$ , Measured in Functional Test)	$V_{GS(Q)}$	1.5	2.4	3	Vdc
Drain-Source On-Voltage ( $V_{GS} = 10\text{ Vdc}$ , $I_D = 1.63\text{ Adc}$ )	$V_{DS(on)}$	—	0.26	—	Vdc

**Dynamic Characteristics (1)**

Reverse Transfer Capacitance ( $V_{DS} = 50\text{ Vdc} \pm 30\text{ mV(rms)ac}$ @ 1 MHz, $V_{GS} = 0\text{ Vdc}$ )	$C_{rss}$	—	0.6	—	pF
Output Capacitance ( $V_{DS} = 50\text{ Vdc} \pm 30\text{ mV(rms)ac}$ @ 1 MHz, $V_{GS} = 0\text{ Vdc}$ )	$C_{oss}$	—	350	—	pF
Input Capacitance ( $V_{DS} = 50\text{ Vdc}$ , $V_{GS} = 0\text{ Vdc} \pm 30\text{ mV(rms)ac}$ @ 1 MHz)	$C_{iss}$	—	330	—	pF

**Functional Tests** (In Freescale Test Fixture, 50 ohm system)  $V_{DD} = 50\text{ Vdc}$ ,  $I_{DQ} = 150\text{ mA}$ ,  $P_{out} = 330\text{ W Peak}$  (39.6 W Avg.),  $f = 1400\text{ MHz}$ , Pulsed, 300  $\mu\text{sec}$  Pulse Width, 12% Duty Cycle

Power Gain	$G_{ps}$	16.5	18	19.5	dB
Drain Efficiency	$\eta_D$	59 <sup>(2)</sup>	60.5 <sup>(2)</sup>	—	%
Input Return Loss	IRL	—	-12	-9	dB

**Pulsed RF Performance** (In Freescale Application Test Fixture, 50 ohm system)  $V_{DD} = 50\text{ Vdc}$ ,  $I_{DQ} = 150\text{ mA}$ ,  $P_{out} = 330\text{ W Peak}$  (39.6 W Avg.),  $f_1 = 1200\text{ MHz}$ ,  $f_2 = 1300\text{ MHz}$  and  $f_3 = 1400\text{ MHz}$ , Pulsed, 300  $\mu\text{sec}$  Pulse Width, 12% Duty Cycle,  $t_r = 50\text{ ns}$

Relative Insertion Phase	$ \Delta\Phi $	—	10	—	$^\circ$
Gain Flatness	$G_F$	—	0.5	—	dB
Pulse Amplitude Droop	$D_{rp}$	—	0.3	—	dB
Harmonic 2nd and 3rd	H2 & H3	—	-20	—	dBc
Spurious Response		—	-65	—	dBc
Load Mismatch Stability (VSWR = 3:1 at all Phase Angles)	VSWR-S	All Spurs Below -60 dBc			
Load Mismatch Tolerance (VSWR = 5:1 at all Phase Angles)	VSWR-T	No Degradation in Output Power			

1. Part internally matched both on input and output.

2. Drain efficiency is calculated by:  $\eta_D = \frac{100 \times P_{out}}{V_{DD} \times I_{peak}}$  where:  $I_{peak} = (I_{AVG} - I_{DQ}) / \text{Duty Cycle (\%)} + I_{DQ}$ .

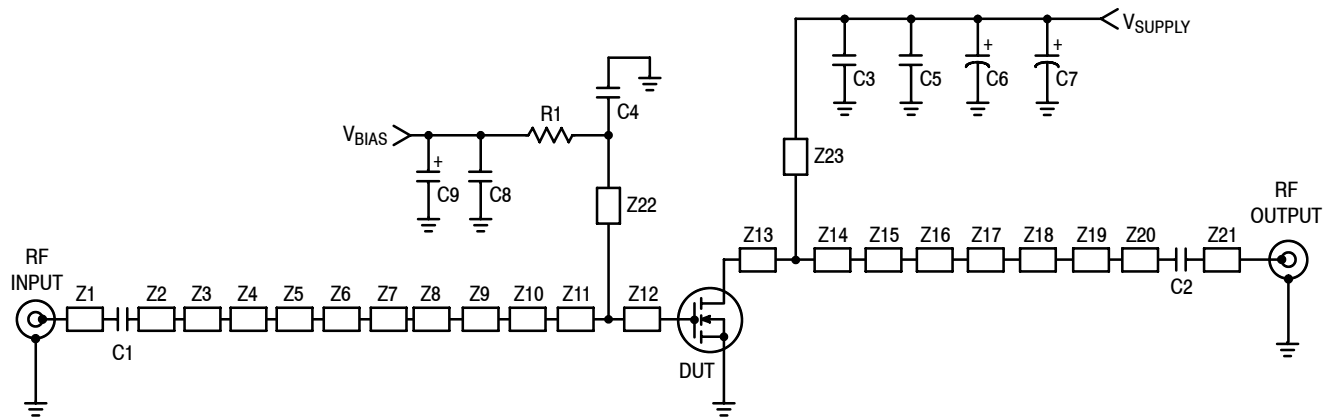

Z1	0.205" x 0.080" Microstrip	Z13	0.110" x 0.866" Microstrip
Z2	0.721" x 0.022" Microstrip	Z14	0.630" x 0.866" Microstrip
Z3	0.080" x 0.104" Microstrip	Z15	0.307" x 0.470" Microstrip
Z4	0.128" x 0.022" Microstrip	Z16	0.045" x 0.221" Microstrip
Z5	0.062" x 0.134" Microstrip	Z17	0.171" x 0.136" Microstrip
Z6	0.440" x 0.022" Microstrip	Z18	0.120" x 0.430" Microstrip
Z7	0.262" x 0.496" Microstrip	Z19	0.964" x 0.136" Microstrip
Z8	0.030" x 0.138" Microstrip	Z20	0.177" x 0.078" Microstrip
Z9	0.256" x 0.028" Microstrip	Z21	0.215" x 0.078" Microstrip
Z10	0.058" x 0.254" Microstrip	Z22	1.577" x 0.070" Microstrip
Z11	0.344" x 0.087" Microstrip	Z23	1.459" x 0.070" Microstrip
Z12	0.110" x 0.087" Microstrip	PCB	Arlon CuClad 250GX-0300-55-22, 0.030", $\epsilon_r = 2.55$

**Figure 1. MRF6V14300HR3(HSR3) Test Circuit Schematic**

**Table 5. MRF6V14300HR3(HSR3) Test Circuit Component Designations and Values**

Part	Description	Part Number	Manufacturer
C1	43 pF Chip Capacitor	ATC100B430JT500XT	ATC
C2	18 pF Chip Capacitor	ATC100B180JT500XT	ATC
C3	33 pF Chip Capacitor	ATC100B330JT500XT	ATC
C4	27 pF Chip Capacitor	ATC100B270JT500XT	ATC
C5	2.2 $\mu$ F, 100 V Chip Capacitor	2225X7R225KT3AB	ATC
C6	470 $\mu$ F, 63 V Electrolytic Capacitor	EMVY630GTR471MMH0S	Multicomp
C7	330 pF, 63 V Electrolytic Capacitor	EMVY630GTR331MMH0S	Multicomp
C8	0.1 $\mu$ F, 35 V Chip Capacitor	CDR33BX104AKYS	Kemet
C9	10 $\mu$ F, 35 V Tantalum Capacitor	T491D106K035AT	Kemet
R1	10 $\Omega$ , 1/4 W Chip Resistor	CRCW120610R0FKEA	Vishay

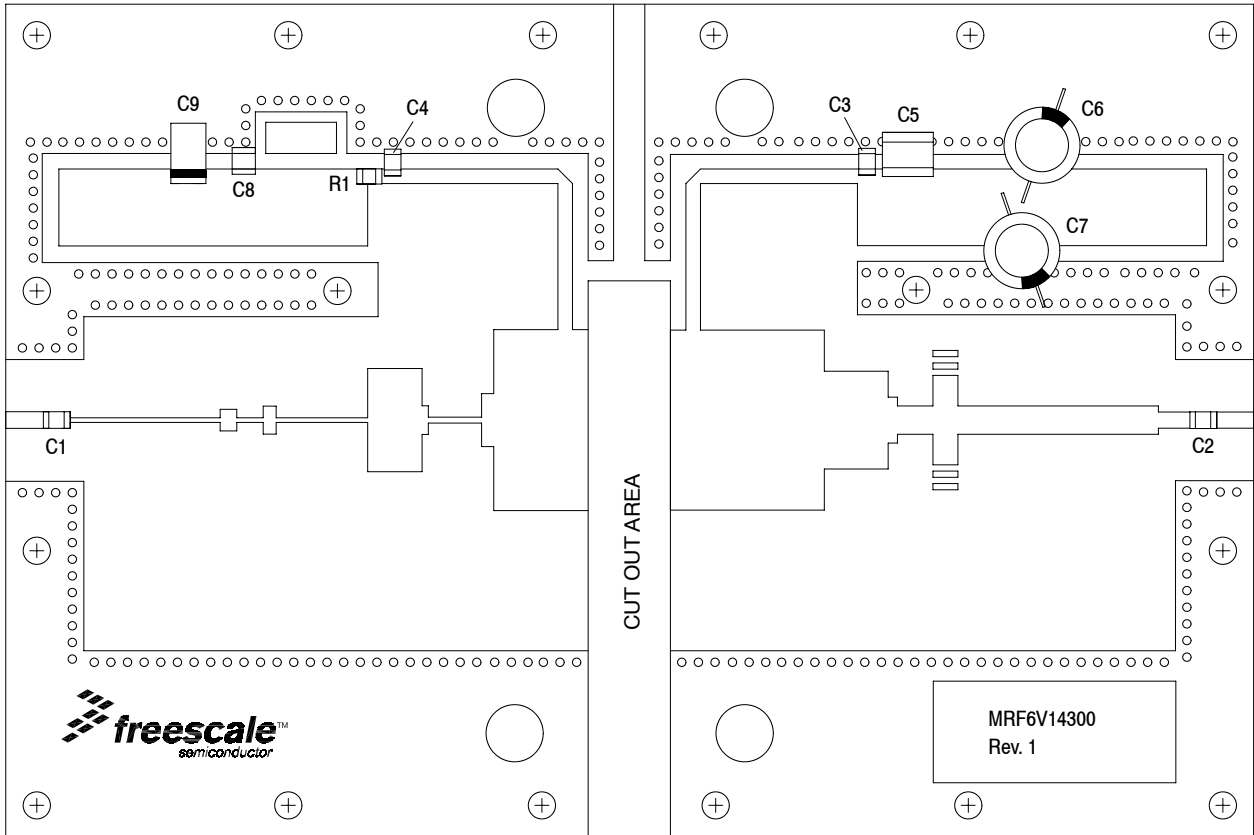

Figure 2. MRF6V14300HR3(HSR3) Test Circuit Component Layout

## TYPICAL CHARACTERISTICS

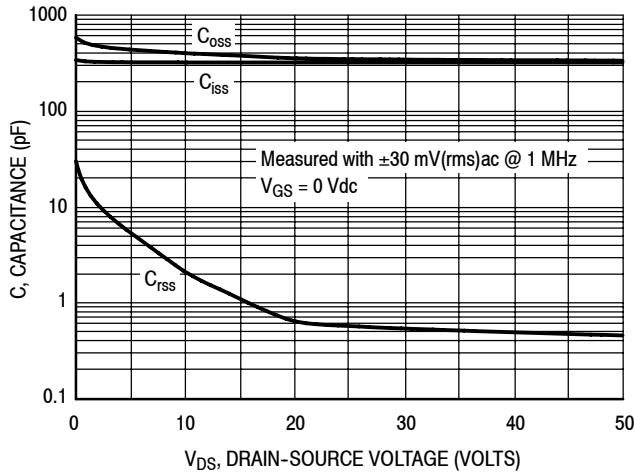

Figure 3. Capacitance versus Drain-Source Voltage

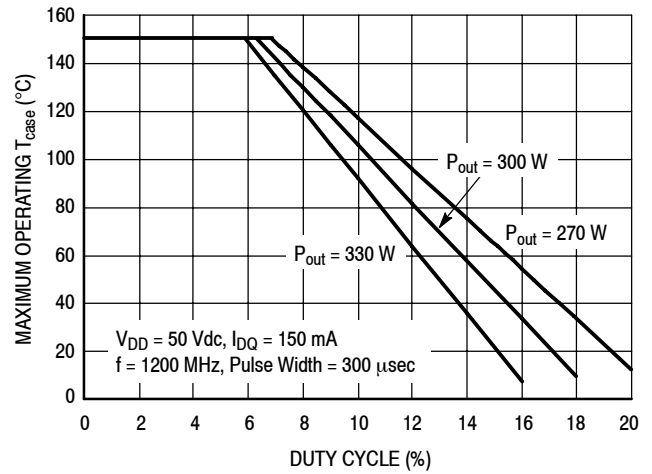

Figure 4. Safe Operating Area

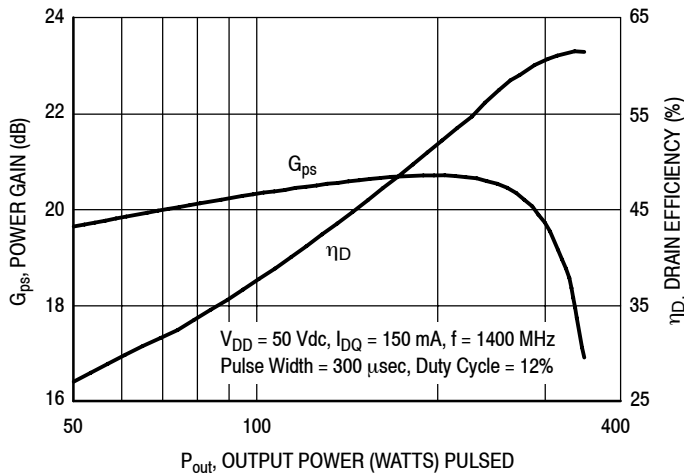

Figure 5. Pulsed Power Gain and Drain Efficiency versus Output Power

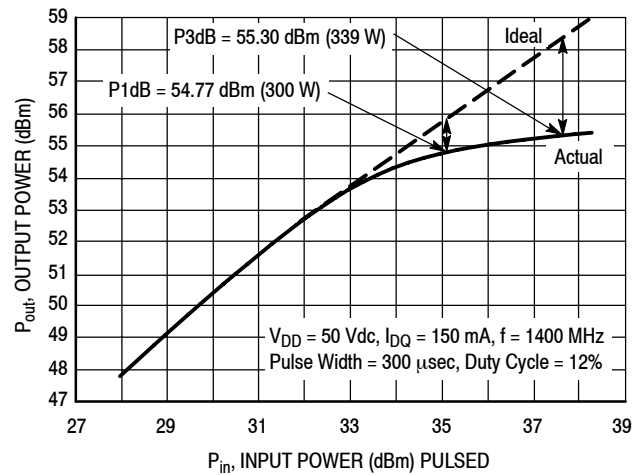

Figure 6. Pulsed Output Power versus Input Power

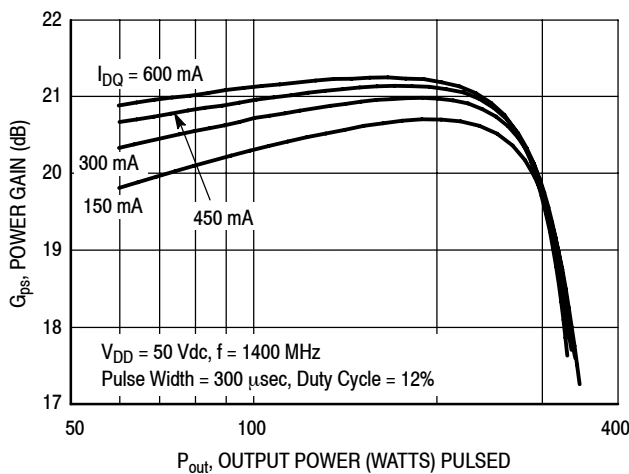

Figure 7. Pulsed Power Gain versus Output Power

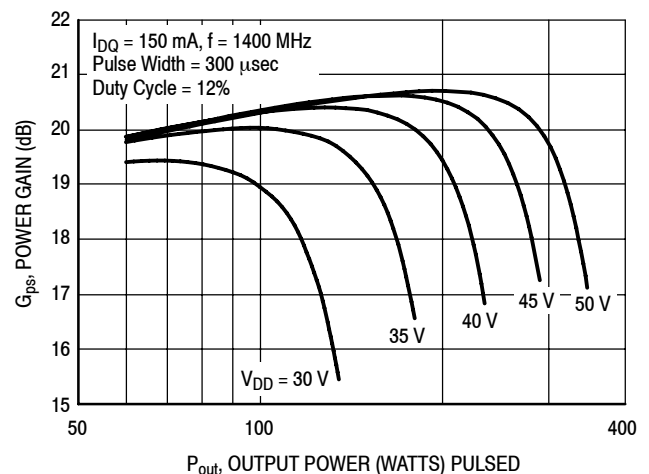
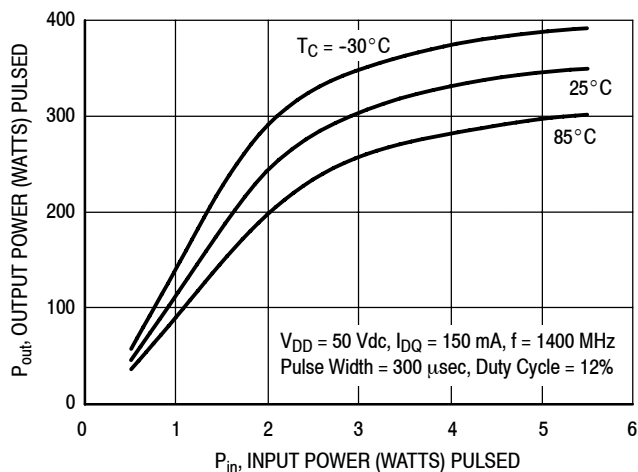
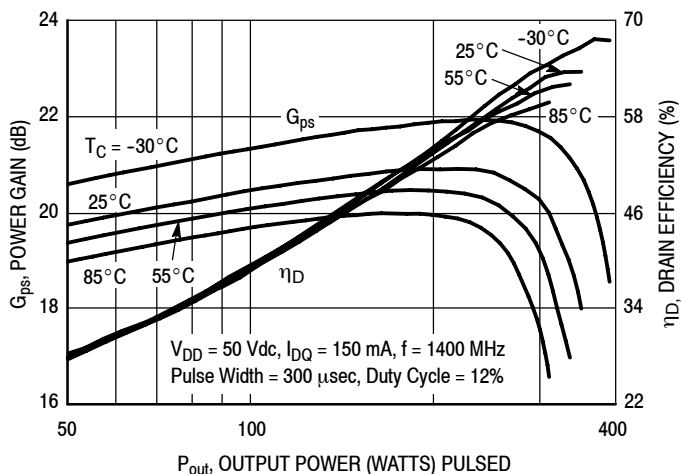

Figure 8. Pulsed Power Gain versus Output Power

### TYPICAL CHARACTERISTICS



**Figure 9. Pulsed Output Power versus Input Power**



**Figure 10. Pulsed Power Gain and Drain Efficiency versus Output Power**

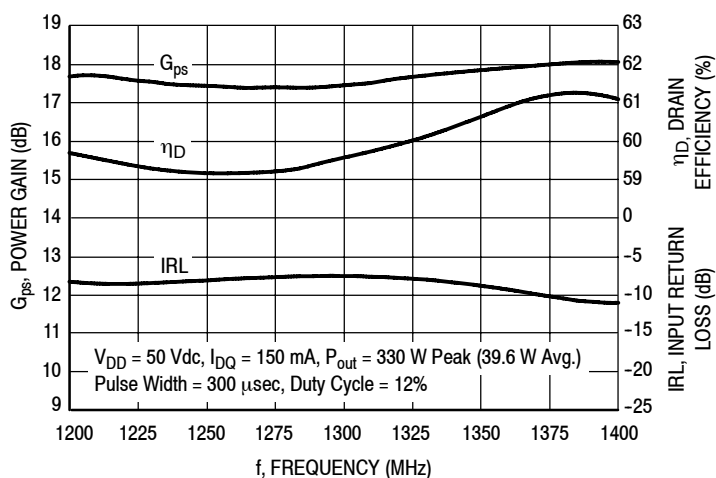

**Figure 11. Broadband Performance @  $P_{out} = 330$  Watts Peak**

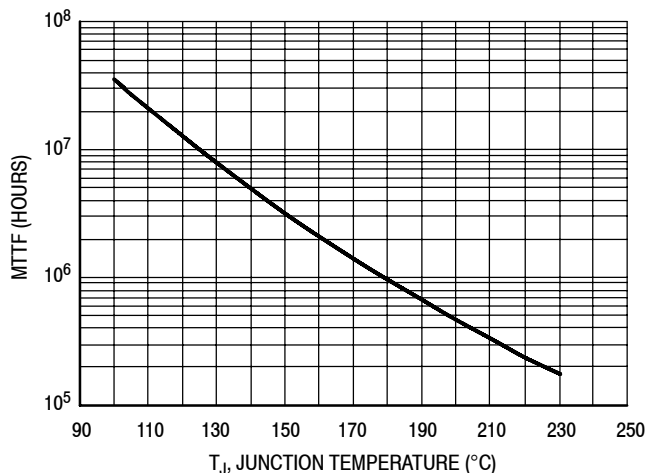

This above graph displays calculated MTTF in hours when the device is operated at  $V_{DD} = 50$  Vdc,  $P_{out} = 330$  W Peak, Pulse Width = 300  $\mu$ sec, Duty Cycle = 12%, and  $\eta_D = 60.5\%$ .

MTTF calculator available at <http://www.freescale.com/rf>. Select Software & Tools/Development Tools/Calculators to access MTTF calculators by product.

**Figure 12. MTTF versus Junction Temperature**

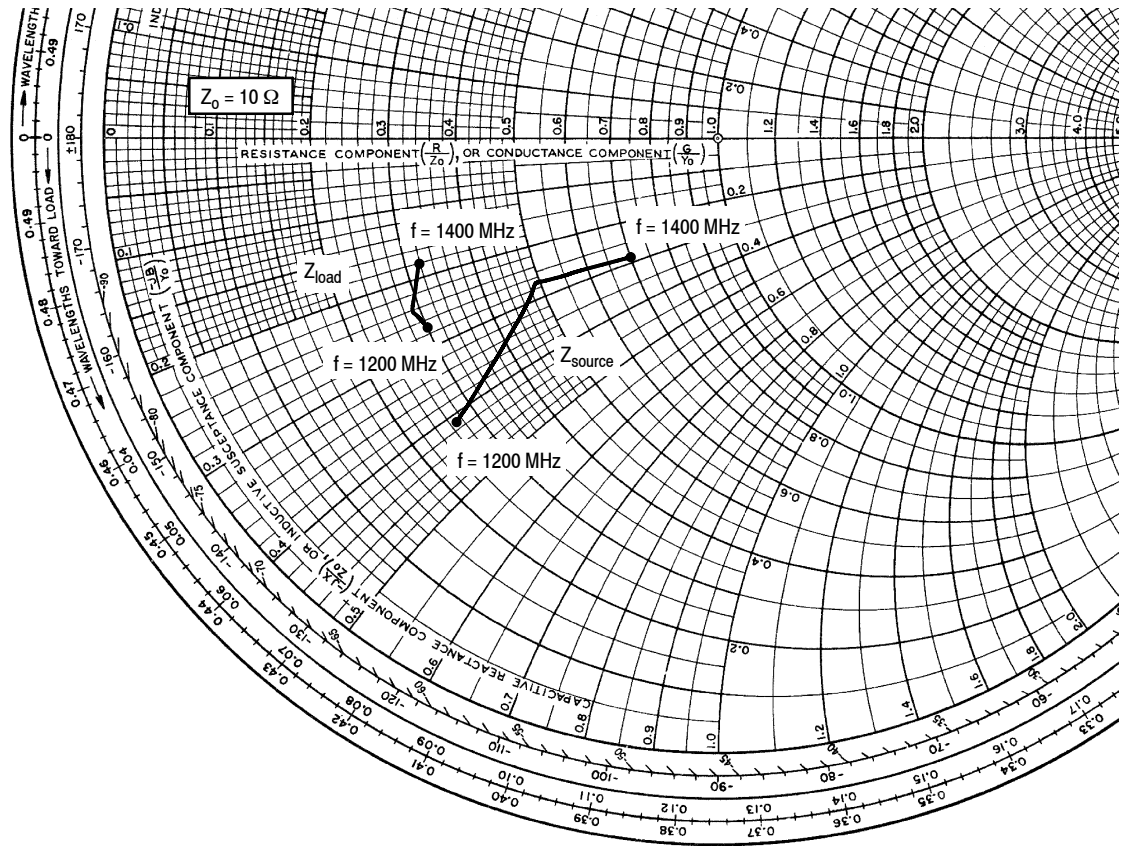

$V_{DD} = 50 \text{ Vdc}$ ,  $I_{DQ} = 150 \text{ mA}$ ,  $P_{out} = 330 \text{ W Peak}$

f MHz	$Z_{source}$ $\Omega$	$Z_{load}$ $\Omega$
1200	$2.70 - j4.10$	$2.97 - j2.66$
1300	$4.93 - j2.66$	$2.85 - j2.40$
1400	$7.01 - j2.87$	$3.17 - j1.78$

$Z_{source}$  = Test circuit impedance as measured from gate to ground.

$Z_{load}$  = Test circuit impedance as measured from drain to ground.

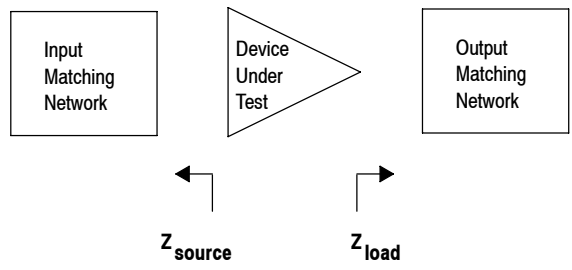
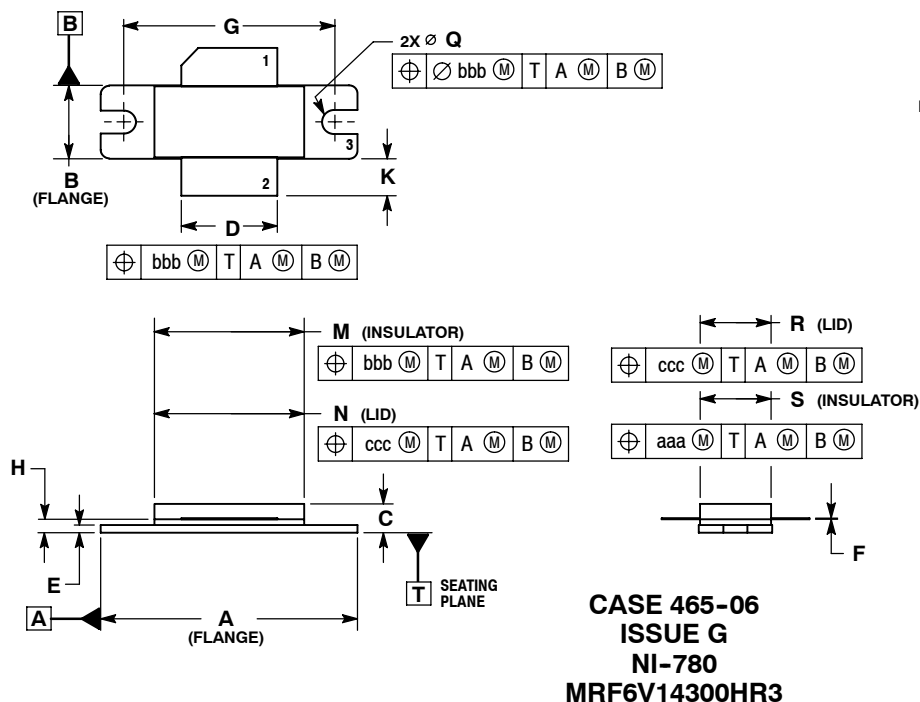

Figure 13. Series Equivalent Source and Load Impedance

## PACKAGE DIMENSIONS



**NOTES:**

1. DIMENSIONING AND TOLERANCING PER ANSI Y14.5M-1994.
2. CONTROLLING DIMENSION: INCH.
3. DELETED
4. DIMENSION H IS MEASURED 0.030 (0.762) AWAY FROM PACKAGE BODY.

DIM	INCHES		MILLIMETERS	
	MIN	MAX	MIN	MAX
A	1.335	1.345	33.91	34.16
B	0.380	0.390	9.65	9.91
C	0.125	0.170	3.18	4.32
D	0.495	0.505	12.57	12.83
E	0.035	0.045	0.89	1.14
F	0.003	0.006	0.08	0.15
G	1.100 BSC		27.94 BSC	
H	0.057	0.067	1.45	1.70
K	0.170	0.210	4.32	5.33
M	0.774	0.786	19.66	19.96
N	0.772	0.788	19.60	20.00
Q	∅ 0.118	∅ 0.138	∅ 3.00	∅ 3.51
R	0.365	0.375	9.27	9.53
S	0.365	0.375	9.27	9.52
aaa	0.005 REF		0.127 REF	
bbb	0.010 REF		0.254 REF	
ccc	0.015 REF		0.381 REF	

**STYLE 1:**

- PIN 1. DRAIN
2. GATE
3. SOURCE

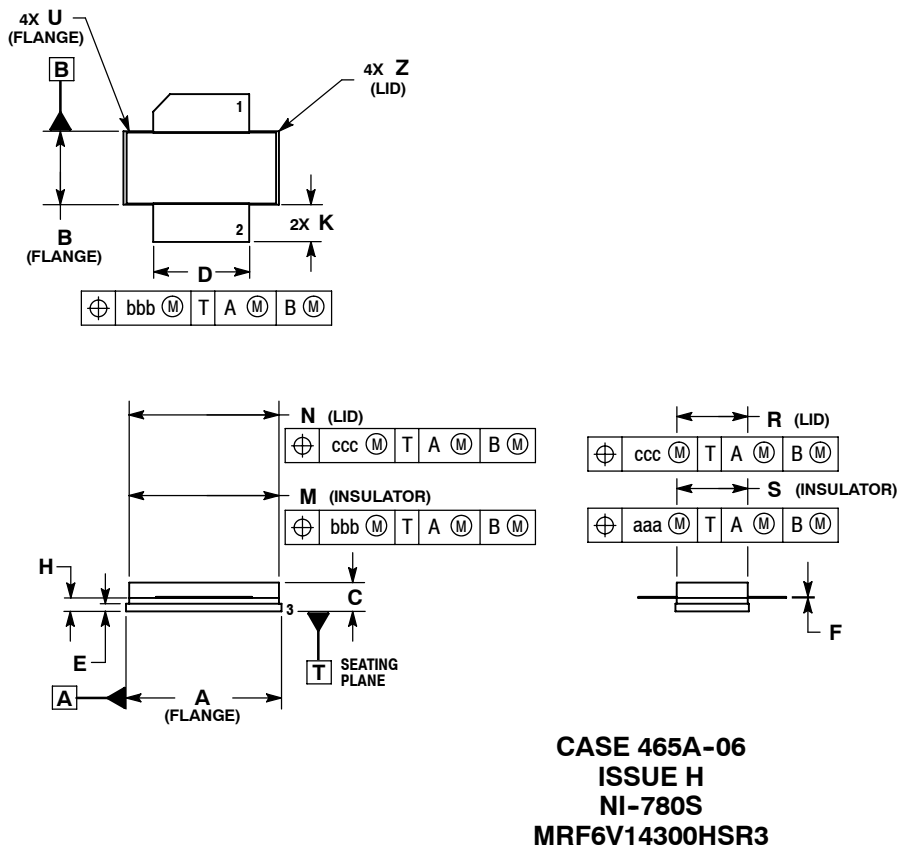

**NOTES:**

1. DIMENSIONING AND TOLERANCING PER ANSI Y14.5M-1994.
2. CONTROLLING DIMENSION: INCH.
3. DELETED
4. DIMENSION H IS MEASURED 0.030 (0.762) AWAY FROM PACKAGE BODY.

DIM	INCHES		MILLIMETERS	
	MIN	MAX	MIN	MAX
A	0.805	0.815	20.45	20.70
B	0.380	0.390	9.65	9.91
C	0.125	0.170	3.18	4.32
D	0.495	0.505	12.57	12.83
E	0.035	0.045	0.89	1.14
F	0.003	0.006	0.08	0.15
H	0.057	0.067	1.45	1.70
K	0.170	0.210	4.32	5.33
M	0.774	0.786	19.61	20.02
N	0.772	0.788	19.61	20.02
R	0.365	0.375	9.27	9.53
S	0.365	0.375	9.27	9.52
U	---	0.040	---	1.02
Z	---	0.030	---	0.76
aaa	0.005 REF		0.127 REF	
bbb	0.010 REF		0.254 REF	
ccc	0.015 REF		0.381 REF	

**STYLE 1:**

- PIN 1. DRAIN
2. GATE
5. SOURCE



## PRODUCT DOCUMENTATION AND SOFTWARE

Refer to the following documents to aid your design process.

### Application Notes

- AN1955: Thermal Measurement Methodology of RF Power Amplifiers

### Engineering Bulletins

- EB212: Using Data Sheet Impedances for RF LDMOS Devices

### Software

- Electromigration MTTF Calculator
- RF High Power Model

For Software, do a Part Number search at <http://www.freescale.com>, and select the “Part Number” link. Go to the Software & Tools tab on the part’s Product Summary page to download the respective tool.

## REVISION HISTORY

The following table summarizes revisions to this document.

Revision	Date	Description
0	Sept. 2008	<ul style="list-style-type: none"> <li>• Initial Release of Data Sheet</li> </ul>
1	Oct. 2008	<ul style="list-style-type: none"> <li>• Added footnote to describe the formula used to calculate values for Min and Typ Drain Efficiency in the Functional Test table, p. 2</li> <li>• Updated Fig. 4, Safe Operating Area, to show additional curves for 270 W and 300 W output power, p. 5</li> <li>• Added Fig. 12, MTTF versus Junction Temperature, p. 6</li> </ul>
2	Nov. 2008	<ul style="list-style-type: none"> <li>• Changed “multiply by” symbol to “divide by” symbol in the Functional Test Drain Efficiency formula footnote, p. 2</li> </ul>
3	Apr. 2010	<ul style="list-style-type: none"> <li>• Operating Junction Temperature increased from 200°C to 225°C in Maximum Ratings table and related “Continuous use at maximum temperature will affect MTTF” footnote added, p. 1</li> <li>• Reporting of pulsed thermal data now shown using the <math>Z_{\theta JC}</math> symbol, p. 1</li> <li>• Added Electromigration MTTF Calculator and RF High Power Model availability to Product Software, p. 9</li> </ul>

## **How to Reach Us:**

### **Home Page:**

[www.freescale.com](http://www.freescale.com)

### **Web Support:**

<http://www.freescale.com/support>

### **USA/Europe or Locations Not Listed:**

Freescale Semiconductor, Inc.  
Technical Information Center, EL516  
2100 East Elliot Road  
Tempe, Arizona 85284  
1-800-521-6274 or +1-480-768-2130  
[www.freescale.com/support](http://www.freescale.com/support)

### **Europe, Middle East, and Africa:**

Freescale Halbleiter Deutschland GmbH  
Technical Information Center  
Schatzbogen 7  
81829 Muenchen, Germany  
+44 1296 380 456 (English)  
+46 8 52200080 (English)  
+49 89 92103 559 (German)  
+33 1 69 35 48 48 (French)  
[www.freescale.com/support](http://www.freescale.com/support)

### **Japan:**

Freescale Semiconductor Japan Ltd.  
Headquarters  
ARCO Tower 15F  
1-8-1, Shimo-Meguro, Meguro-ku,  
Tokyo 153-0064  
Japan  
0120 191014 or +81 3 5437 9125  
[support.japan@freescale.com](mailto:support.japan@freescale.com)

### **Asia/Pacific:**

Freescale Semiconductor China Ltd.  
Exchange Building 23F  
No. 118 Jianguo Road  
Chaoyang District  
Beijing 100022  
China  
+86 10 5879 8000  
[support.asia@freescale.com](mailto:support.asia@freescale.com)

### **For Literature Requests Only:**

Freescale Semiconductor Literature Distribution Center  
1-800-441-2447 or +1-303-675-2140  
Fax: +1-303-675-2150  
[LDCForFreescaleSemiconductor@hibbertgroup.com](mailto:LDCForFreescaleSemiconductor@hibbertgroup.com)

Information in this document is provided solely to enable system and software implementers to use Freescale Semiconductor products. There are no express or implied copyright licenses granted hereunder to design or fabricate any integrated circuits or integrated circuits based on the information in this document.

Freescale Semiconductor reserves the right to make changes without further notice to any products herein. Freescale Semiconductor makes no warranty, representation or guarantee regarding the suitability of its products for any particular purpose, nor does Freescale Semiconductor assume any liability arising out of the application or use of any product or circuit, and specifically disclaims any and all liability, including without limitation consequential or incidental damages. "Typical" parameters that may be provided in Freescale Semiconductor data sheets and/or specifications can and do vary in different applications and actual performance may vary over time. All operating parameters, including "Typicals", must be validated for each customer application by customer's technical experts. Freescale Semiconductor does not convey any license under its patent rights nor the rights of others. Freescale Semiconductor products are not designed, intended, or authorized for use as components in systems intended for surgical implant into the body, or other applications intended to support or sustain life, or for any other application in which the failure of the Freescale Semiconductor product could create a situation where personal injury or death may occur. Should Buyer purchase or use Freescale Semiconductor products for any such unintended or unauthorized application, Buyer shall indemnify and hold Freescale Semiconductor and its officers, employees, subsidiaries, affiliates, and distributors harmless against all claims, costs, damages, and expenses, and reasonable attorney fees arising out of, directly or indirectly, any claim of personal injury or death associated with such unintended or unauthorized use, even if such claim alleges that Freescale Semiconductor was negligent regarding the design or manufacture of the part.

Freescale™ and the Freescale logo are trademarks of Freescale Semiconductor, Inc. All other product or service names are the property of their respective owners.

© Freescale Semiconductor, Inc. 2008, 2010. All rights reserved.