

THIS DOCUMENT IS THE PROPERTY OF KEYSTONE ELECTRONICS CORP. AND SHALL NOT BE REPRODUCED, DISTRIBUTED OR USED AS A BASIS FOR MANUFACTURE WITHOUT PRIOR WRITTEN PERMISSION FROM KEYSTONE ELECTRONICS CORP.

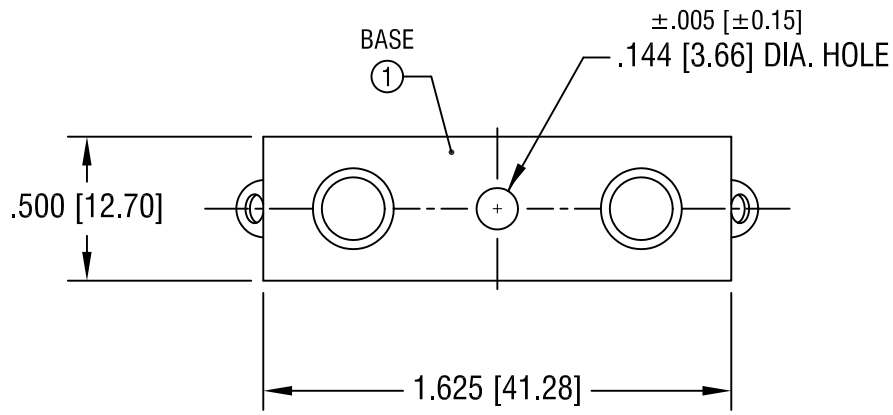
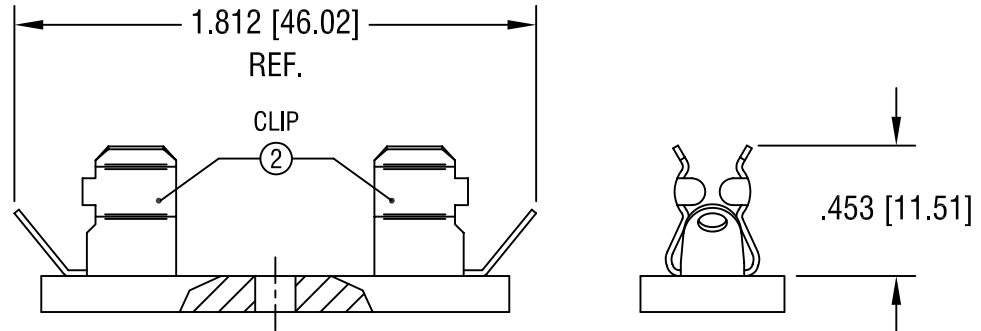

NOTES:

- ① BASE:
MAT'L: .125 [3.18] TH'K
GPO-3, FLAME RETARDANT,
UL 94V-0
- ② CLIP: P/N 3535

KEYSTONE ELECTRONICS CORP.			
ASTORIA, N.Y. 11105-2017			
PART NAME		3AG FUSE HOLDER	
MATERIAL		AS NOTED	
FINISH		DRN BY	DATE
AS NOTED		BOONE	10.16.96
		APPD	SCALE
		LN	1.5X
TOLERANCES	INCH [MM]	CODE	DWG NO.
DECIMAL	± .015 [± 0.38]	C	3540
ANGULAR	± 1°		
UNLESS OTHERWISE SPECIFIED			

DATE	DESCRIPTION	REV.