

## N-channel 800 V, 1.50 $\Omega$ typ., 4 A MDmesh™ K5 Power MOSFET in a DPAK package

Datasheet - production data

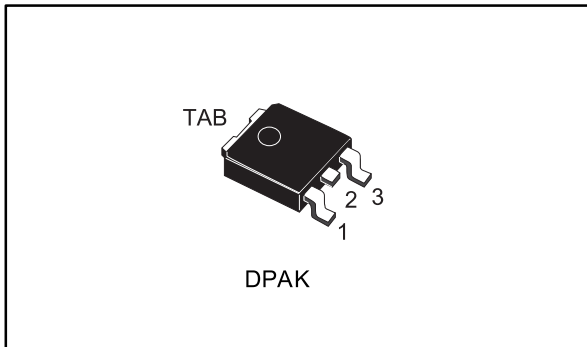
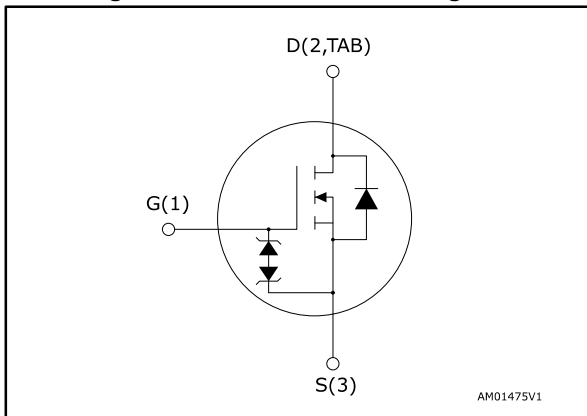

Figure 1: Internal schematic diagram



### Features

Order code	V <sub>DS</sub>	R <sub>DS(on)</sub> max.	I <sub>D</sub>
STD5N80K5	800 V	1.75 $\Omega$	4 A

- Industry's lowest R<sub>DS(on)</sub> x area
- Industry's best FoM (figure of merit)
- Ultra-low gate charge
- 100% avalanche tested
- Zener-protected

### Applications

- Switching applications

### Description

This very high voltage N-channel Power MOSFET is designed using MDmesh™ K5 technology based on an innovative proprietary vertical structure. The result is a dramatic reduction in on-resistance and ultra-low gate charge for applications requiring superior power density and high efficiency.

Table 1: Device summary

Order code	Marking	Package	Packing
STD5N80K5	5N80K5	DPAK	Tape and reel

---

## Contents

<b>1</b>	<b>Electrical ratings .....</b>	<b>3</b>
<b>2</b>	<b>Electrical characteristics .....</b>	<b>4</b>
	2.1 Electrical characteristics (curves).....	6
<b>3</b>	<b>Test circuits .....</b>	<b>8</b>
<b>4</b>	<b>Package information .....</b>	<b>9</b>
	4.1 DPAK (TO-252) type A2 mechanical data.....	10
	4.2 DPAK (TO-252) packing information.....	13
<b>5</b>	<b>Revision history .....</b>	<b>15</b>

# 1 Electrical ratings

**Table 2: Absolute maximum ratings**

Symbol	Parameter	Value	Unit
V <sub>GS</sub>	Gate-source voltage	± 30	V
I <sub>D</sub>	Drain current (continuous) at T <sub>C</sub> = 25 °C	4	A
I <sub>D</sub>	Drain current (continuous) at T <sub>C</sub> = 100 °C	2.3	A
I <sub>D</sub> <sup>(1)</sup>	Drain current (pulsed)	16	A
P <sub>TOT</sub>	Total dissipation at T <sub>C</sub> = 25 °C	60	W
dv/dt <sup>(2)</sup>	Peak diode recovery voltage slope	4.5	V/ns
dv/dt <sup>(3)</sup>	MOSFET dv/dt ruggedness	50	
T <sub>j</sub>	Operating junction temperature range	- 55 to 150	°C
T <sub>stg</sub>	Storage temperature range		

**Notes:**

<sup>(1)</sup>Pulse width limited by safe operating area

<sup>(2)</sup>I<sub>SD</sub> ≤ 4 A, di/dt = 100 A/μs; V<sub>DS</sub> peak < V<sub>(BR)DSS</sub>, V<sub>DD</sub> = 640 V

<sup>(3)</sup>V<sub>DS</sub> ≤ 640 V

**Table 3: Thermal data**

Symbol	Parameter	Value	Unit
R <sub>thj-case</sub>	Thermal resistance junction-case	2.08	°C/W
R <sub>thj-pcb</sub> <sup>(1)</sup>	Thermal resistance junction-pcb	50	°C/W

**Notes:**

<sup>(1)</sup>When mounted on FR-4 board of 1 inch<sup>2</sup>, 2 oz Cu

**Table 4: Avalanche characteristics**

Symbol	Parameter	Value	Unit
I <sub>AR</sub>	Avalanche current, repetitive or not repetitive (pulse width limited by T <sub>jmax</sub> )	1.2	A
E <sub>AS</sub>	Single pulse avalanche energy (starting T <sub>j</sub> = 25 °C, I <sub>D</sub> = I <sub>AR</sub> , V <sub>DD</sub> = 50 V)	165	mJ

## 2 Electrical characteristics

$T_C = 25\text{ °C}$  unless otherwise specified

**Table 5: On/off-state**

Symbol	Parameter	Test conditions	Min.	Typ.	Max.	Unit
$V_{(BR)DSS}$	Drain-source breakdown voltage	$V_{GS} = 0\text{ V}$ , $I_D = 1\text{ mA}$	800			V
$I_{DSS}$	Zero gate voltage drain current	$V_{GS} = 0\text{ V}$ , $V_{DS} = 800\text{ V}$			1	$\mu\text{A}$
		$V_{GS} = 0\text{ V}$ , $V_{DS} = 800\text{ V}$ $T_C = 125\text{ °C}^{(1)}$			50	$\mu\text{A}$
$I_{GSS}$	Gate body leakage current	$V_{DS} = 0\text{ V}$ , $V_{GS} = \pm 20\text{ V}$			$\pm 10$	$\mu\text{A}$
$V_{GS(th)}$	Gate threshold voltage	$V_{DD} = V_{GS}$ , $I_D = 100\text{ }\mu\text{A}$	3	4	5	V
$R_{DS(on)}$	Static drain-source on-resistance	$V_{GS} = 10\text{ V}$ , $I_D = 2\text{ A}$		1.50	1.75	$\Omega$

**Notes:**

<sup>(1)</sup>Defined by design, not subject to production test.

**Table 6: Dynamic**

Symbol	Parameter	Test conditions	Min.	Typ.	Max.	Unit
$C_{iss}$	Input capacitance	$V_{DS} = 100\text{ V}$ , $f = 1\text{ MHz}$ , $V_{GS} = 0\text{ V}$	-	177	-	pF
$C_{oss}$	Output capacitance		-	15	-	pF
$C_{rss}$	Reverse transfer capacitance		-	0.3	-	pF
$C_{o(tr)}^{(1)}$	Equivalent capacitance time related	$V_{GS} = 0$ , $V_{DS} = 0\text{ to }640\text{ V}$	-	33	-	pF
$C_{o(er)}^{(2)}$	Equivalent capacitance energy related				12	
$R_g$	Intrinsic gate resistance	$f = 1\text{ MHz}$ , $I_D = 0\text{ A}$	-	16	-	$\Omega$
$Q_g$	Total gate charge	$V_{DD} = 640\text{ V}$ , $I_D = 4\text{ A}$ $V_{GS} = 10\text{ V}$ (see <a href="#">Figure 15: "Test circuit for gate charge behavior"</a> )	-	5	-	nC
$Q_{gs}$	Gate-source charge		-	1.7	-	nC
$Q_{gd}$	Gate-drain charge		-	2.9	-	nC

**Notes:**

<sup>(1)</sup> $C_{o(tr)}$  is a constant capacitance value that gives the same charging time as  $C_{oss}$  while  $V_{DS}$  is rising from 0 to 80%  $V_{DSS}$ .

<sup>(2)</sup> $C_{o(er)}$  is a constant capacitance value that gives the same stored energy as  $C_{oss}$  while  $V_{DS}$  is rising from 0 to 80%  $V_{DSS}$ .

Table 7: Switching times

Symbol	Parameter	Test conditions	Min.	Typ.	Max.	Unit
$t_{d(on)}$	Turn-on delay time	$V_{DD} = 400\text{ V}$ , $I_D = 2\text{ A}$ , $R_G = 4.7\ \Omega$ $V_{GS} = 10\text{ V}$ (see <a href="#">Figure 14: "Test circuit for resistive load switching times"</a> and <a href="#">Figure 19: "Switching time waveform"</a> )	-	12.7	-	ns
$t_r$	Rise time		-	11.7	-	ns
$t_{d(off)}$	Turn-off delay time		-	23	-	ns
$t_f$	Fall time		-	14.8	-	ns

Table 8: Source-drain diode

Symbol	Parameter	Test conditions	Min.	Typ.	Max.	Unit
$I_{SD}$	Source-drain current		-		4	A
$I_{SDM}^{(1)}$	Source-drain current (pulsed)		-		16	A
$V_{SD}^{(2)}$	Forward on voltage	$I_{SD} = 4\text{ A}$ , $V_{GS} = 0\text{ V}$	-		1.5	V
$t_{rr}$	Reverse recovery time	$I_{SD} = 4\text{ A}$ , $di/dt = 100\text{ A}/\mu\text{s}$ , $V_{DD} = 60\text{ V}$ (see <a href="#">Figure 16: "Test circuit for inductive load switching and diode recovery times"</a> )	-	265		ns
$Q_{rr}$	Reverse recovery charge		-	1.59		$\mu\text{C}$
$I_{RRM}$	Reverse recovery current		-	12		A
$t_{rr}$	Reverse recovery time	$I_{SD} = 4\text{ A}$ , $di/dt = 100\text{ A}/\mu\text{s}$ $V_{DD} = 60\text{ V}$ , $T_j = 150\text{ }^\circ\text{C}$ (see <a href="#">Figure 16: "Test circuit for inductive load switching and diode recovery times"</a> )	-	386		ns
$Q_{rr}$	Reverse recovery charge		-	2.18		$\mu\text{C}$
$I_{RRM}$	Reverse recovery current		-	11.3		A

**Notes:**

(1)Pulse width limited by safe operating area

(2)Pulsed: pulse duration = 300  $\mu\text{s}$ , duty cycle 1.5%

Table 9: Gate-source Zener diode

Symbol	Parameter	Test conditions	Min.	Typ.	Max.	Unit
$V_{(BR)GSO}$	Gate-source breakdown voltage	$I_{GS} = \pm 1\text{ mA}$ , $I_D = 0\text{ A}$	30	-	-	V

The built-in back-to-back Zener diodes are specifically designed to enhance the ESD performance of the device. The Zener voltage facilitates efficient and cost-effective device integrity protection, thus eliminating the need for additional external componentry.

2.1 Electrical characteristics (curves)

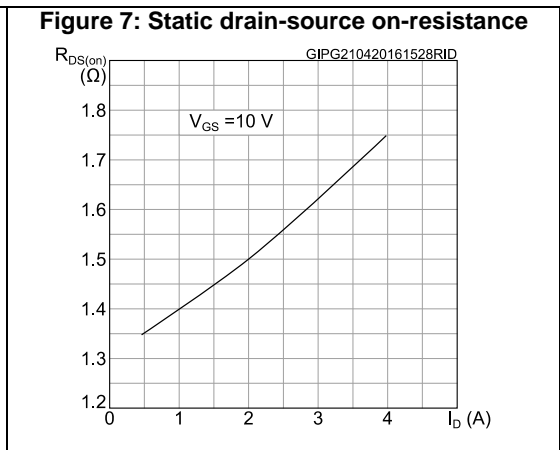
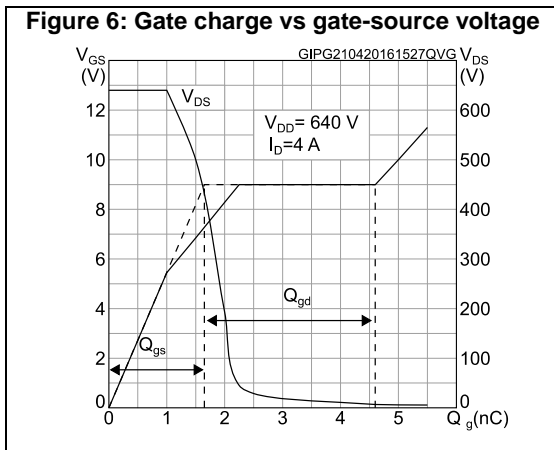
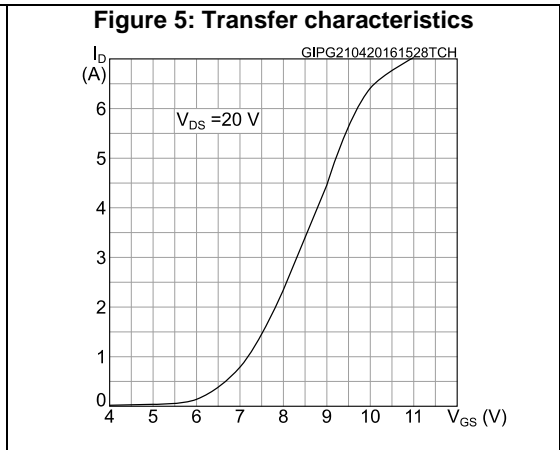
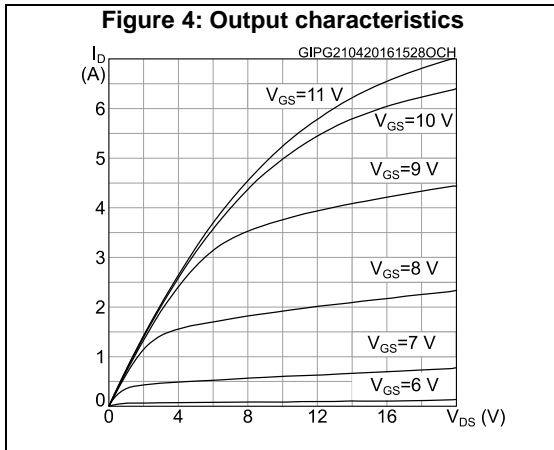
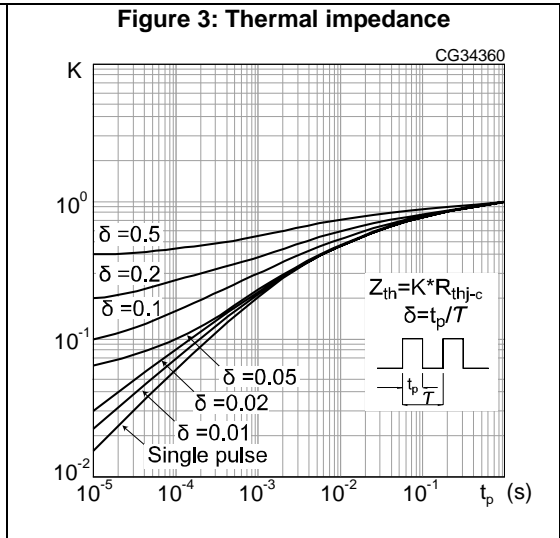
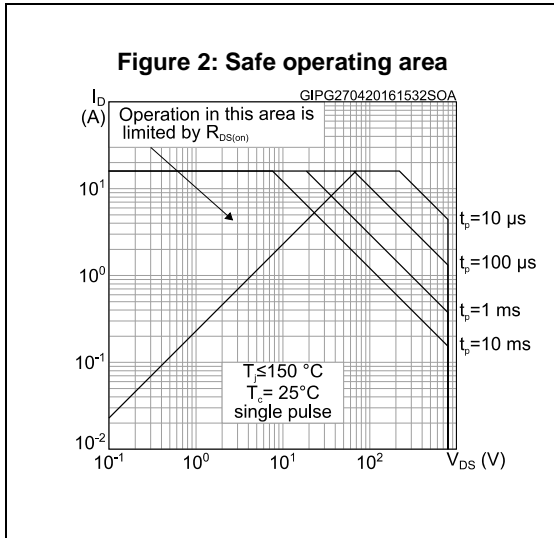

Figure 8: Capacitance variations

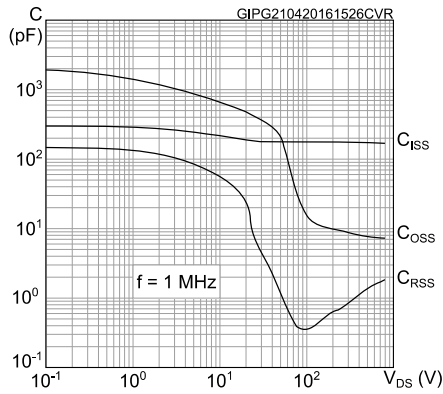

Figure 9: Normalized gate threshold voltage vs temperature

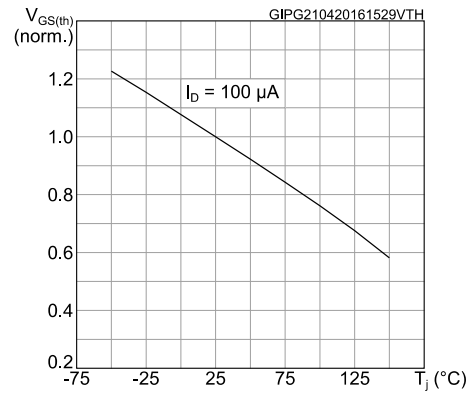

Figure 10: Normalized on-resistance vs temperature

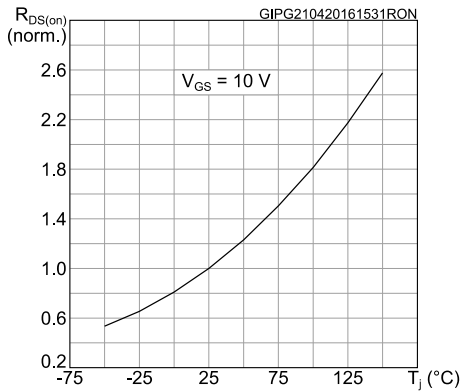

Figure 11: Normalized V(BR)DSS vs temperature

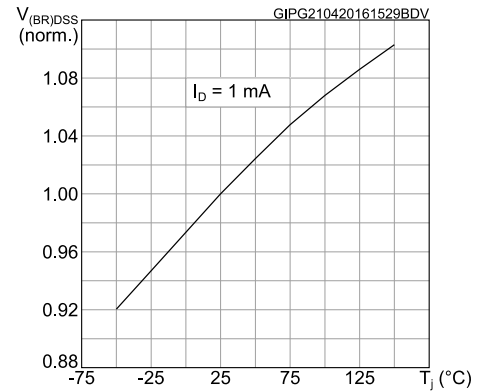

Figure 12: Maximum avalanche energy vs starting Tj

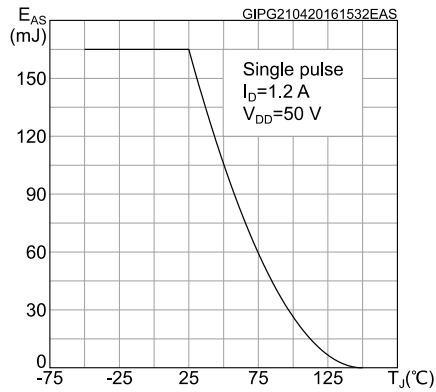
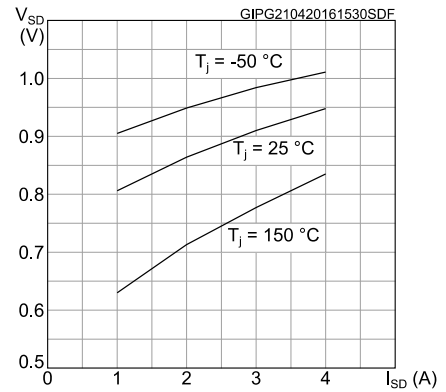
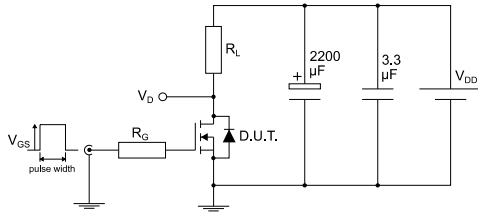

Figure 13: Source-drain diode forward characteristics



### 3 Test circuits

**Figure 14: Test circuit for resistive load switching times**



AM01468v1

**Figure 15: Test circuit for gate charge behavior**

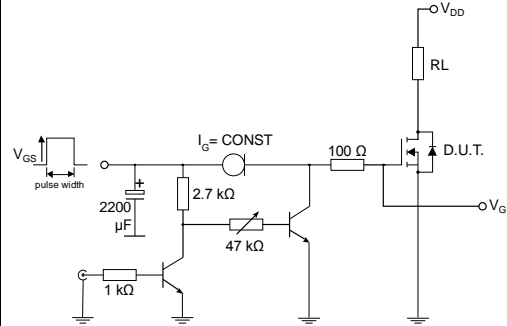

AM01469v10

**Figure 16: Test circuit for inductive load switching and diode recovery times**

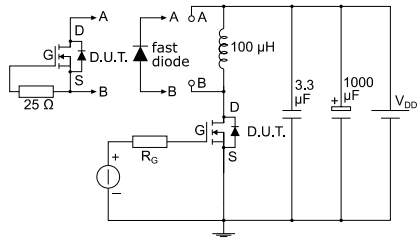

AM01470v1

**Figure 17: Unclamped inductive load test circuit**

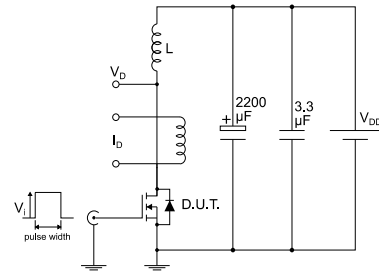

AM01471v1

**Figure 18: Unclamped inductive waveform**

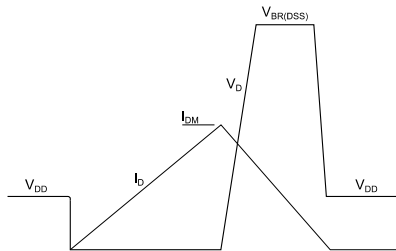

AM01472v1

**Figure 19: Switching time waveform**

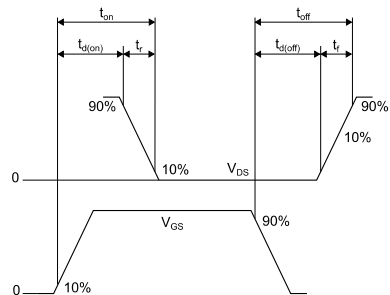

AM01473v1



## 4 Package information

In order to meet environmental requirements, ST offers these devices in different grades of ECOPACK® packages, depending on their level of environmental compliance. ECOPACK® specifications, grade definitions and product status are available at: [www.st.com](http://www.st.com). ECOPACK® is an ST trademark.

### 4.1 DPAK (TO-252) type A2 mechanical data

Figure 20: DPAK (TO-252) type A2 package outline

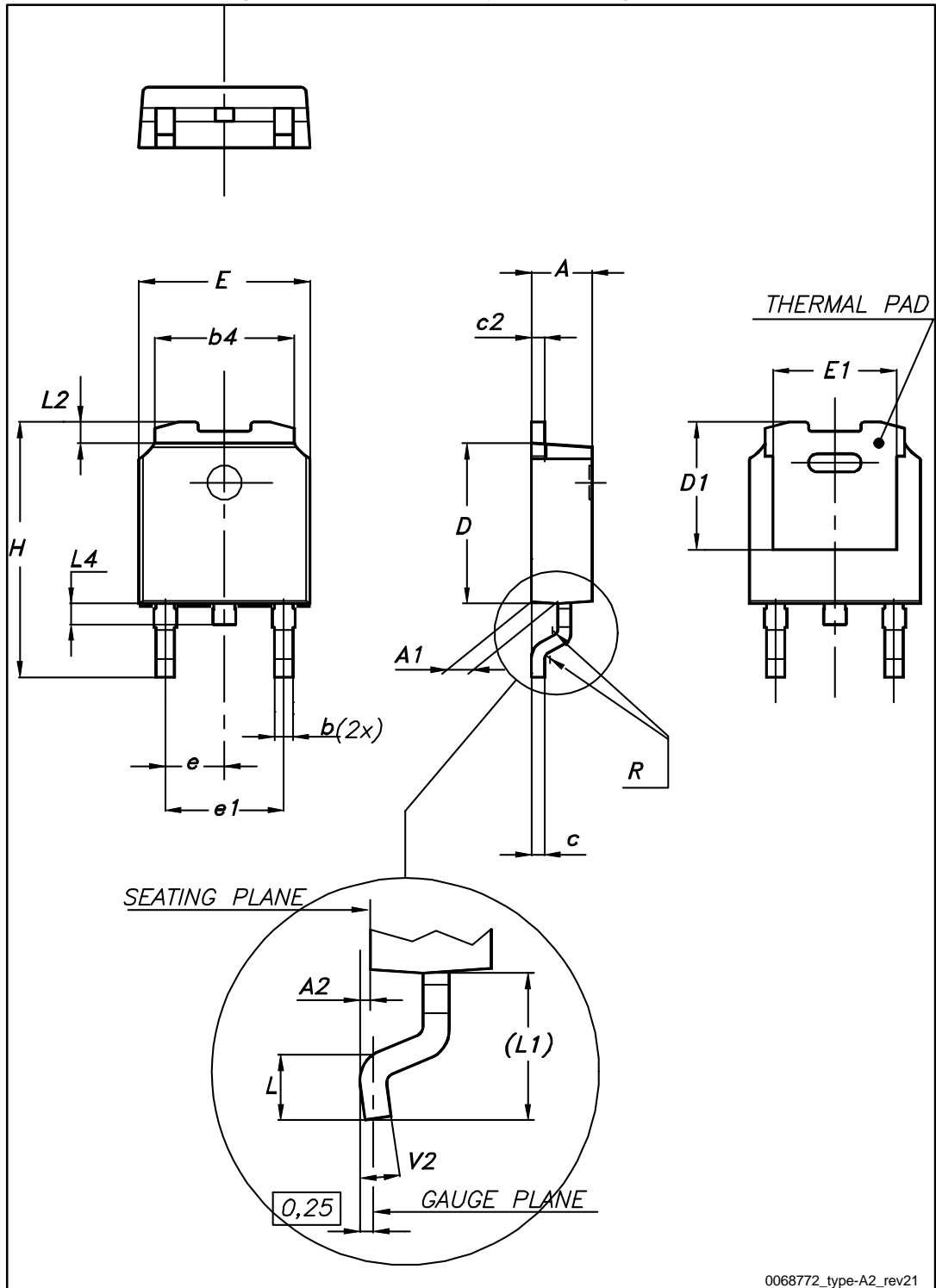
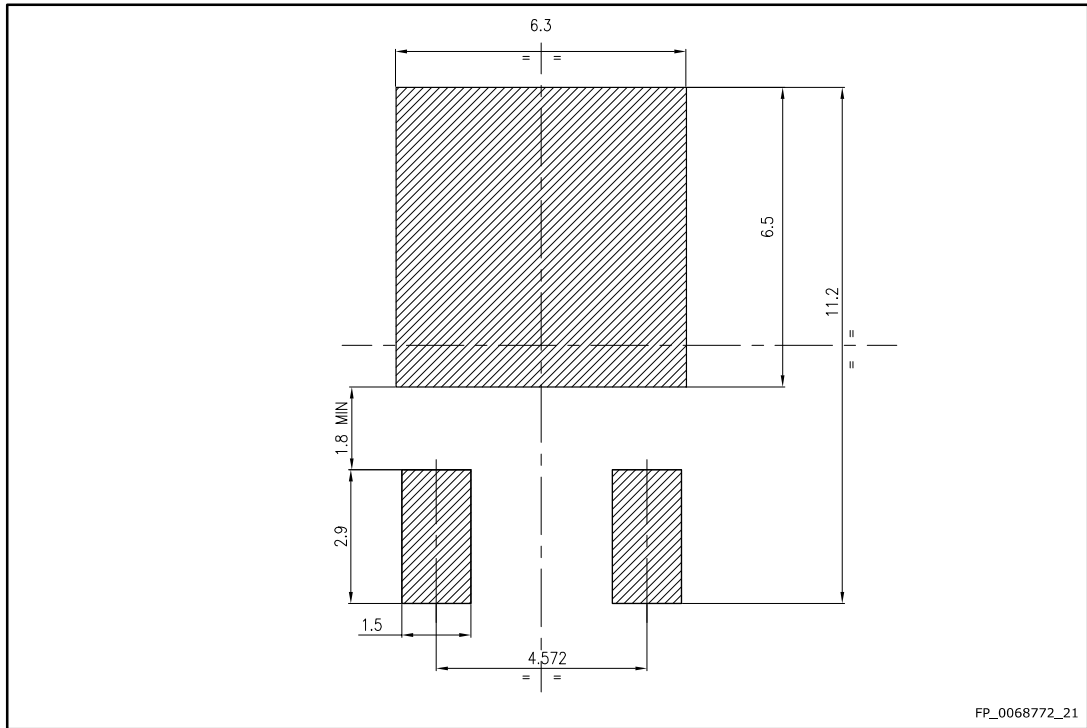

Table 10: DPAK (TO-252) type A2 mechanical data

Dim.	mm		
	Min.	Typ.	Max.
A	2.20		2.40
A1	0.90		1.10
A2	0.03		0.23
b	0.64		0.90
b4	5.20		5.40
c	0.45		0.60
c2	0.48		0.60
D	6.00		6.20
D1	4.95	5.10	5.25
E	6.40		6.60
E1	5.10	5.20	5.30
e	2.16	2.28	2.40
e1	4.40		4.60
H	9.35		10.10
L	1.00		1.50
L1	2.60	2.80	3.00
L2	0.65	0.80	0.95
L4	0.60		1.00
R		0.20	
V2	0°		8°

Figure 21: DPAK (TO-252) recommended footprint (dimensions are in mm)



### 4.2 DPAK (TO-252) packing information

Figure 22: DPAK (TO-252) tape outline

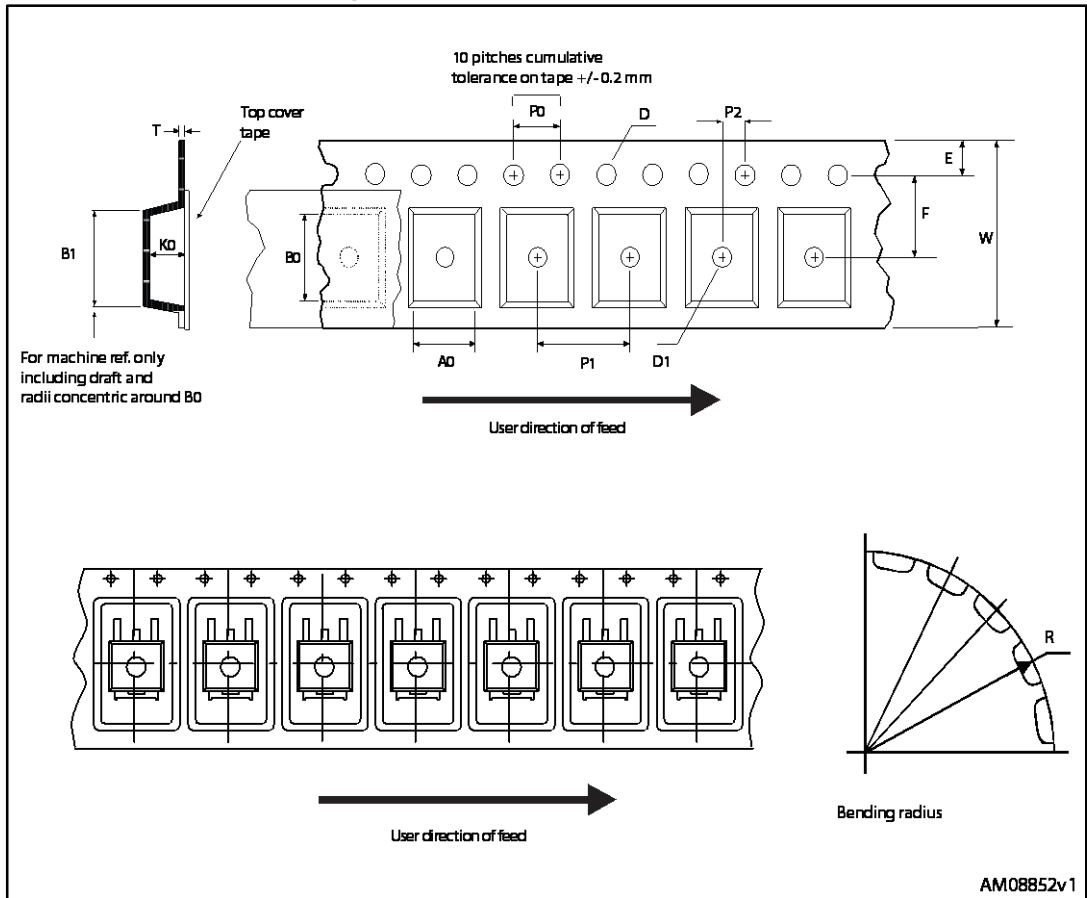

Figure 23: DPAK (TO-252) reel outline

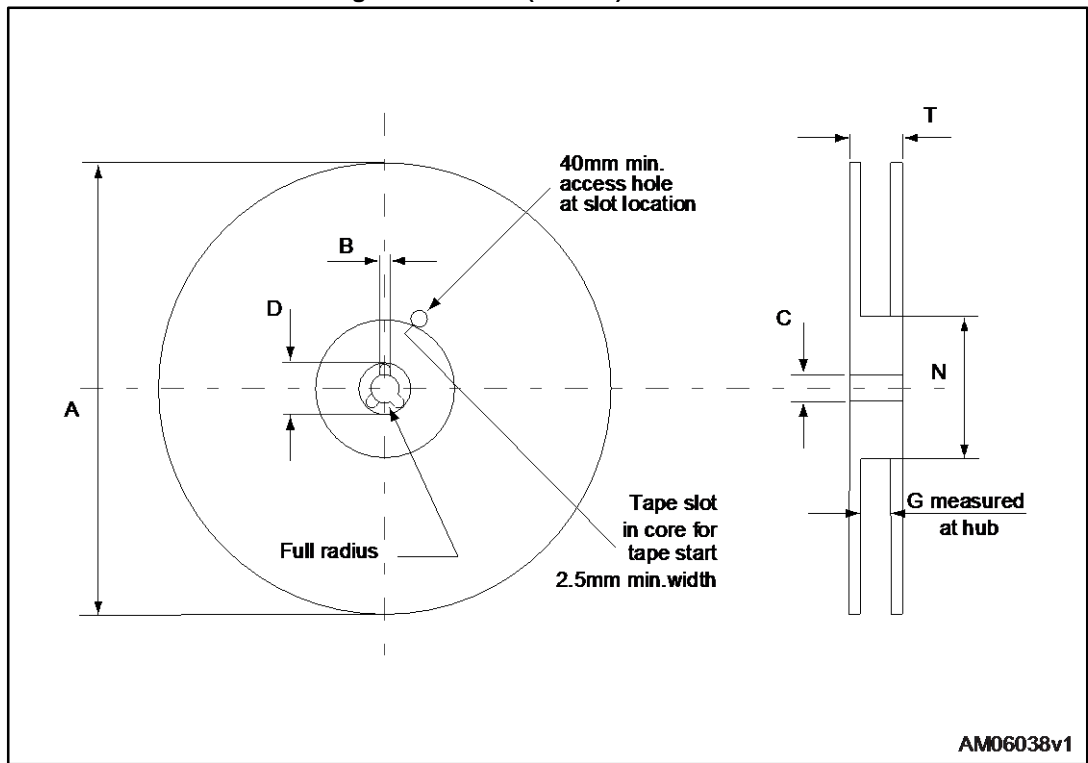

Table 11: DPAK (TO-252) tape and reel mechanical data

Tape			Reel		
Dim.	mm		Dim.	mm	
	Min.	Max.		Min.	Max.
A0	6.8	7	A		330
B0	10.4	10.6	B	1.5	
B1		12.1	C	12.8	13.2
D	1.5	1.6	D	20.2	
D1	1.5		G	16.4	18.4
E	1.65	1.85	N	50	
F	7.4	7.6	T		22.4
K0	2.55	2.75			
P0	3.9	4.1	Base qty.		2500
P1	7.9	8.1	Bulk qty.		2500
P2	1.9	2.1			
R	40				
T	0.25	0.35			
W	15.7	16.3			

## 5 Revision history

Table 12: Document revision history

Date	Revision	Changes
08-Jan-2016	1	First release.
09-May-2016	2	Modified: title Modified: <i>Table 2: "Absolute maximum ratings", Table 3: "Thermal data", Table 5: "On/off-state", Table 6: "Dynamic", Table 7: "Switching times" and Table 8: "Source-drain diode"</i> Added: <i>Section 3.1: "Electrical characteristics (curves)"</i> Modified: <i>Section 4: "Test circuits"</i> Minor text changes

**IMPORTANT NOTICE – PLEASE READ CAREFULLY**

STMicroelectronics NV and its subsidiaries ("ST") reserve the right to make changes, corrections, enhancements, modifications, and improvements to ST products and/or to this document at any time without notice. Purchasers should obtain the latest relevant information on ST products before placing orders. ST products are sold pursuant to ST's terms and conditions of sale in place at the time of order acknowledgement.

Purchasers are solely responsible for the choice, selection, and use of ST products and ST assumes no liability for application assistance or the design of Purchasers' products.

No license, express or implied, to any intellectual property right is granted by ST herein.

Resale of ST products with provisions different from the information set forth herein shall void any warranty granted by ST for such product.

ST and the ST logo are trademarks of ST. All other product or service names are the property of their respective owners.

Information in this document supersedes and replaces information previously supplied in any prior versions of this document.

© 2016 STMicroelectronics – All rights reserved