

Nais

6PDT FLATPACK 2AMP DIL RELAY

NL-RELAYS

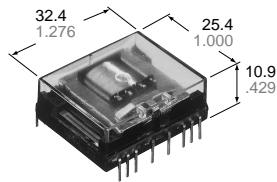

NLE Amber Relays

mm inch

FEATURES

- Space saving dimensions — 25.4 mm × 32.4 mm × 10.9 mm
1.000 inch × 1.276 inch × 0.429 inch
- Latching types available
- Low operating power — 400 mW (single side stable)
Transistor compatible
- High breakdown voltage for transient protection — 1,000 Vrms between open contacts, contact sets, and 1,500 V FCC surge between open contacts
- Soldering flux inflow completely prevented

SPECIFICATIONS

Contacts

Arrangement**1	6 Form C		
Contact material	gold-clad silver**2		
Initial contact resistance, max. (By voltage drop 6 V DC 1 A)	100 mΩ		
Rating (resistive)	Nominal switching capacity	2 A 30 V DC	
	Max. switching power	60 VA, 60 W	
	Max. switching voltage	125 V AC, 30 V DC	
	Max. switching current	2 A	
Expected life (min. operations)	Mechanical	5×10 ⁷	
	Electrical (resistive)	2 A 30 V DC	5×10 ⁵
		0.6 A 100 V DC	10 ⁶

**1 MBB contact types also available: 2 MBB, 4 MBB & 6 MBB

**2 Gold capped silver-palladium contact also available

Coil (polarized) (at 25°C 77°F)

Minimum operating power	Approx. 460 mW
Nominal operating power	up to 60 V DC: Approx. 720 mW 110 V DC: Approx. 900 mW
Minimum set and reset power	Approx. 1,000 mW
Nominal set and reset power	Approx. 1,600 mW

Remarks

- * Specifications will vary with foreign standards certification ratings.
- *1 Measurement at same location as "Initial breakdown voltage" section
- *2 Detection current: 10 mA
- *3 Excluding contact bounce time
- *4 Half-wave pulse of sine wave: 11ms; detection time: 10μs
- *5 Half-wave pulse of sine wave: 6ms
- *6 Detection time: 10μs
- *7 Refer to 5. Conditions for operation, transport and storage mentioned in AMBIENT ENVIRONMENT (Page 61).

Characteristics

Maximum operating speed		50 cps
Initial insulation resistance*1		Min. 100 MΩ at 500 V DC
Breakdown voltage*2	Between open contacts, contact sets	1,000 Vrms
	Between contacts and coil	2,000 Vrms
Operate time*3 (at nominal voltage)		Max. 15 ms (Approx. 10 ms)
Release time (without diode)*3 (at nominal voltage)		Max. 10 ms (Approx. 5 ms)
Temperature rise		Max. 65°C with nominal coil voltage and at switching current 2 A
Shock resistance	Functional*4	Min. 147 m/s ² {15 G}
	Destructive*5	Min. 980 m/s ² {100 G}
Vibration resistance	Functional*6	58.8 m/s ² {6 G}, 10 to 55 Hz at double amplitude of 1 mm
	Destructive	117.6 m/s ² {12 G}, 10 to 55 Hz at double amplitude of 2 mm
Conditions for operation, transport and storage*7 (Not freezing and condensing at low temperature)	Ambient temp.	-40°C to +55°C -40°F to +131°F
	Humidity	5 to 85% R.H.
Unit weight		Approx. 17 g 60 oz

TYPICAL APPLICATIONS

Telecommunications, security equipment, detection systems.

ORDERING INFORMATION

Ex. NL 6 EB X 6M L2 DC48V 1

Contact arrangement	Classification of type	MBB function	Operating function	Coil voltage	Contact material
6: 6 Form C	EB: Amber sealed type	Nil: 6 Form C	Nil: Single side stable L2: 2 coil latching	DC: 5, 6, 12, 24, 48, 60, 110 V	Nil: Gold-clad silver 1: Gold-cap over silver palladium

- (Notes) 1. For UL/CSA or VDE recognized types, add suffix UL/CSA or VDE.
2. Standard packing Carton: 20 pcs. Case: 200 pcs.

TYPES AND COIL DATA (at 20°C 68°F)

Single side stable

Part No.	Coil voltage, V DC			Coil resistance, Ω (±10%)	Nominal operating power, mW
	Pick-up (max.)	Drop-out (min.)	Maximum allowable		
NL6EBX-DC5V	4.0	0.5	6.0	34.7	720
NL6EBX-DC6V	4.8	0.6	7.2	50	
NL6EBX-DC12V	9.6	1.2	14.4	200	
NL6EBX-DC24V	19.2	2.4	28.8	800	
NL6EBX-DC48V	38.4	4.8	57.6	3,200	
NL6EBX-DC60V	48	6.0	72	5,000	
NL6EBX-DC110V	88	11.0	132	13,467	898

2 coil latching

Part No.	Coil voltage, * V DC			Coil resistance, Ω (±10%)	Nominal operating power, mW
	Set (max.)	Reset (max.)	Maximum allowable		
NL6EBX-L2-DC5V	4.0	4.0	5.5	15.6	1,600**
NL6EBX-L2-DC6V	4.8	4.8	6.6	22.5	
NL6EBX-L2-DC12V	9.6	9.6	13.2	90	
NL6EBX-L2-DC24V	19.2	19.2	26.4	360	
NL6EBX-L2-DC48V	38.4	38.4	52.8	1,440	
NL6EBX-L2-DC60V	48	48	66	2,250	
NL6EBX-L2-DC110V	88	88	121	7,563	

* See NOTE 2

** Two coil latching series are for intermittent operation only.

Power should be applied to coil continuously for no more than two minutes.

DIMENSIONS

mm inch

Single side stable

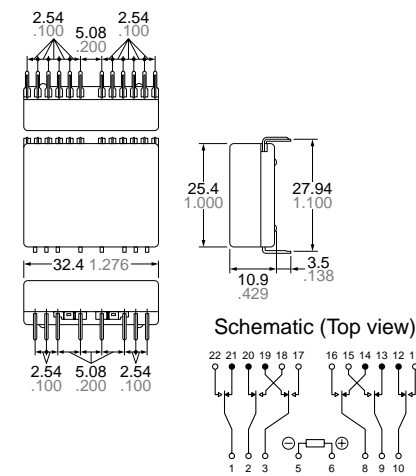

PC board pattern (Bottom view)

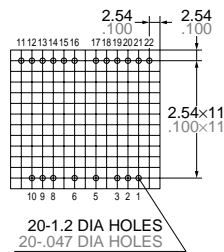

2 coil latching

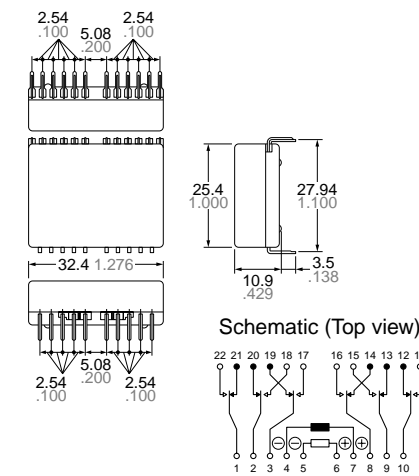

PC board pattern (Bottom view)

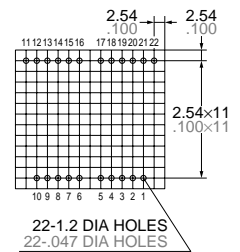

General tolerance: ±0.3 ±0.12

REFERENCE DATA

1. Electrical life (2 A 30 V DC resistive load)

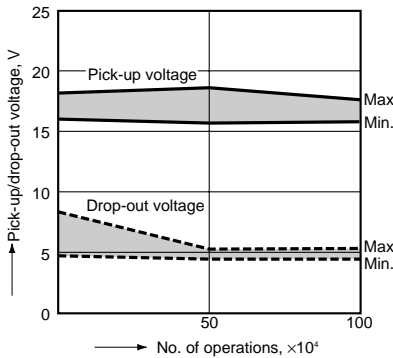

2. Coil temperature rise

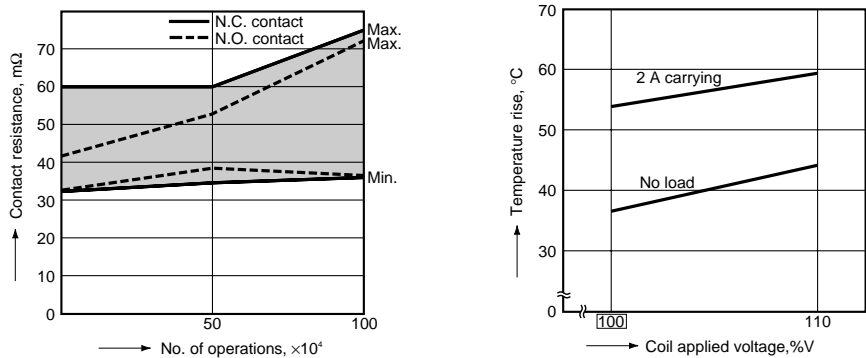

NOTES

On two coil latching relays

1. To maintain insulation between coils, terminals 6 and 7 should be connected to provide common return.

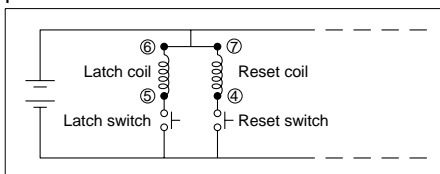

2. Two coil latching relays are for intermittent operation only. Power should be applied to coils for no more than two minutes; continuous operation may burn out the coils.

3. Position of MBB contacts
 2M (2 Form D 4 Form C):
 1-21-22, 10-11-12
 4M (4 Form D 2 Form C):
 1-21-22, 2-20-18, 9-13-15, 10-11-12

For Cautions for Use, see Relay Technical Information